

MFJ

MFJ Plug&Play Intellituner™ Automatic Antenna Tuner

Model MFJ-939



INSTRUCTION MANUAL

CAUTION: Read All Instructions Before Operating Equipment

MFJ ENTERPRISES, INC.

300 Industrial Park Road
Starkville, MS 39759 USA
Tel: 662-323-5869 Fax: 662-323-6551

Contents

The Basics 1
 Introduction 1
 Models 2
 Features 2
 Specifications 2
 Fast Start 3
 Front Panel 4
 Automatic/Semi-Automatic Tuning Mode 5
 Back Panel 6
 Installation 7
 General Tuner Setup and Cabling 8
 Modification to Change Radio Model 8
 Operation 9
 MFJ-939I Icom 9
 Operation 9
 Icom Radio Interface 9
 Connections 9
 MFJ-939K Kenwood 11
 Operation 11
 Kenwood Radio Interface 11
 Connections 11
 MFJ-939Y Yaesu 13
 Operation for FT-100 13
 Operation for FT-450 13
 Operation for FT-857 or FT-897 13
 Operation for FT-950 14
 Yaesu Radio Interface MFJ-5114Y 14
 Connections 14
 Connections for the FT-100 15
 Connections for FT-450 15
 Connections for FT-857 or FT-897 15
 Connections for FT-950 16
 MFJ-939Y3 FT-1000MP FT-2000 FT-9000 18
 Operation for FT-1000MP series of radios 18
 Operation for FT-2000 series of radios 18
 Operation for FTDX-9000 series of radios 18
 Yaesu Radio Interface MFJ-5114Y3 18
 Connections 18
 Connections for FT-1000MP series of radios 19
 Connections for FT-2000 series of radios 19
 Connections for FTDX-9000 series of radios 20
 MFJ-939Y4 FT-2000 21
 Operation for FT-2000 series of radios 21
 Yaesu Radio Interface MFJ-5114Y4 21
 Connections for FT-2000 series of radios 21
 Modification For Use With Alinco 22
 Alinco Radio Interface 22
 Connections 22
 Operation 22
 Miscellaneous 23
 ANTENNA MEMORY 23
 INTELLITUNE™ ALGORITHM 23
 LC Limits 23
 MORSE CODE AND BEEPS 24
 TRANSCEIVER FOLDBACK 24

GROUNDING HINTS.....25
 ANTENNA SYSTEM HINTS.....25
 Location.....25
 Matching Problems.....25
 Appendices27
 Resetting the Tuner27
 Factory Defaults27
 Delete Entire Antenna Memory.....28
 Delete Antenna Memory Bank.....28
 Total Reset.....28
 Self Test28
 Power-Down Circuit Test29
 Relay Test30
 Frequency Counter Calibration30
 SWR Bridge Calibration31
 Jumper Settings.....32
 IN CASE OF DIFFICULTY33
 TECHNICAL ASSISTANCE.....33
 LIST OF ACCESSORIES33
 FULL 12-MONTH WARRANTY35

Figures

Figure 1 General Setup.....3
 Figure 2 MFJ-939 Front Panel.....4
 Figure 3 Button Action5
 Figure 4 MFJ-939 Back Panel.....6
 Figure 6 General Setup.....8
 Figure 7 Icom Interface Cable.....9
 Figure 8 Kenwood Interface Cable.....12
 Figure 9 Yaesu Interface Cable (FT-100/-450/-857/-897/-950).14
 Figure 10 Yaesu Interface Cable (1000MP/2000/9000 series).19
 Figure 11 Yaesu Interface Cable (FT-2000 series).....21
 Figure 12 Alinco Interface Cable.22
 Figure 13 Power-On Operations.27
 Figure 14 Block Diagram34

Tables

Table 1 Icom.....9
 Table 2 Kenwood.....11
 Table 3 Yaesu14
 Table 4 Y3 Interface18
 Table 5 Y4 Interface21
 Table 6 Alinco22
 Table 7 Memory Resolution23
 Table 8 Tuner Beeps.....24
 Table 9 Failure Messages.29
 Table 10 Jumper JP1 Setting32
 Table 11 Jumper JP2 Setting32
 Table 12 Jumper JP4 Setting32

Notes:

THE BASICS

Introduction

The MFJ-939 *Plug&Play IntelliTuner*[™] is a simple to install and convenient antenna tuner for use with Icom, Alinco, Kenwood, or Yaesu radios. The MFJ-939 comes complete with interface cable and programmed for your particular radio.

The MFJ-939 *Plug&Play IntelliTuner*[™] lets you rapidly tune any unbalanced or single-wire antenna automatically. MFJ's exclusive *InstantRecall*[™], *IntelliTune*[™] and *AdaptiveSearch*[™] algorithms give you fast automatic tuning with more than 20,000 non-volatile *VirtualAntenna*[™] memories. The antenna has eight banks of memory; with over 2500 non-volatile memories for tuner settings.

The tuner includes a highly efficient switching L-network with wide matching capability, 1.8 to 30 MHz coverage, a radio interface port, and heavy-duty 10 amp/1000 volt relays. It is rated at 200 watts SSB/CW.

A maximum of 256 values of inductance and 256 values of capacitance are available. With the capacitance switched between the input and output side, this provides a total of 131,072 L/C tuning combinations. The nominal tuning ranges are 0 to 24 μ H and 0 to 3900 pF.

The MFJ-939 *Plug&Play IntelliTuner*[™] learns and remembers. When you transmit, it automatically adjusts for minimum SWR and remembers the frequency and tuner settings, safely stored in non-volatile memory. The next time you operate on that frequency (or close to it) and antenna, the tuner settings are instantly restored and you're ready to operate in milliseconds. The antenna has two sets of four banks of memory, which can learn and remember more than 2500 frequencies and tuner settings. A total of 20000 settings.

When you key your transmitter, MFJ's *InstantRecall*[™] checks its memory to see if you have operated on that frequency before. If so, tuning is instantaneous and you're ready to operate. If not, MFJ's *IntelliTune*[™] algorithm (based on MFJ's famous SWR Analyzer technology) kicks in. It measures the complex impedance of your antenna. Next, it calculates the components it needs and instantly snaps them in. Finally, it fine-tunes to minimize SWR, and you're ready to operate – typically in a fraction of a second.

If the antenna impedance is not within the tuner's measurement range, MFJ's *AdaptiveSearch*[™] algorithm goes into action. Frequency is measured and relevant components values are determined. Only those values are searched for fast tuning. If it still cannot find a match, the search is performed again using a different search pattern.

The minimum power to tune is approximately two watts, with maximum SWR tuning accuracy occurring at tuning power levels of 10-20 watts.

Like all MFJ's *IntelliTuners*[™], the MFJ-939 supports radio tuner interfaces that are compatible with Alinco EDX-2 tuner, Icom AH-3 and AH-4 tuners, Kenwood AT-300 tuner, Yaesu FC-30 tuner, and Yaesu FH-1 and FH-2 remote controls.

When your station radio is upgraded or changed the MFJ-939 can be changed from one radio model to another with the optional interface cables MFJ-5114A (for Alinco), MFJ-5114I (for Icom), MFJ-5114K (for Kenwood); and MFJ-5114Y/Y3/Y4 (for Yaesu) that are available from MFJ Enterprises, Inc. So as the station changes the tuner can change with the station.

The MFJ-939 tuner enters a "sleep" mode when idle and when no transmit signal is present, turning off the microprocessor clock to avoid the generation of spurious signals.

Models

- MFJ-939I Icom IC-706, IC-707, IC-718, IC-725, IC-728, IC-736, IC-738, IC-746, IC-756, IC-7000 and compatibles
- MFJ-939K Kenwood TS-50S, TS-450S, TS-480HX, TS-570S, TS590, TS-690S, TS-850S, TS-870S, TS-2000, and compatibles
- MFJ-939Y Yaesu FT-100, FT-450, FT-847, FT-857, FT-897, FT-950, and compatibles
- MFJ-939Y3 Yaesu FT-1000MP and FTdx-9000
- MFJ-939Y4 Yaesu FT-2000, and FT-5000

Features

- Automatically matches antennas from 6 to 1600 ohms impedance (SWR up to 32:1)
- Handles 200 watts SSB/CW
- Tunes in less than 15 seconds, usually less than 5 seconds
- Over 20,000 non-volatile memories for tuner settings
- Eight memory banks with over 2500 memories per bank
- Highly efficient switching L-network matching circuit
- 1.8 to 30 MHz continuous frequency coverage
- Audio SWR meter
- Built-in frequency counter for remembering frequency-specific matching values
- Built-in radio interface circuitry for compatible radios
- SO-239 coax fed antenna connector
- SO-239 coax to single wire adaptor

Specifications

- Impedance matching range : 6 to 1600 ohms
- SWR matching range : Up to 8:1 for < 50 ohms and up to 32:1 for > 50 ohms
- Minimum power for tuning : 2 watts
- Maximum power while tuning : 100 watts with fold back, 20 watts without fold back
- RF power limit : 200 watts SSB/CW
- Frequency range : 1.8 to 30 MHz continuous coverage
- Frequency counter accuracy : ± 1 kHz across HF bands
- A/D conversion resolution : 8-bit
- Capacitance range : 0 to 3961 pF nominal (256 values)
- Inductance range : 0 to 24.86 μ H nominal (256 values)
- Relay rating : 10 amp 1000 volts
- Relay electrical life : 100,000 operations
- Relay mechanical life : 10 million operations
- Memory endurance : 1 million erase/write cycles
- Memory data retention : > 200 years
- Power supply requirements : 12 - 15 volts DC
- Current consumption : 750 mA or less
- Dimensions : 6 1/2 \times 2 1/8 \times 8 1/4 in; 165 \times 54 \times 210 mm (w \times h \times d)
- Weight : Approx. 2.3 lb; 1.04 kg

† Specifications and design are subject to change without notice.

FAST START

WARNING

- **Never operate the tuner with its cover removed. Contact with the components inside the tuner while transmitting will result in painful RF burns.**
- **Locate the tuner so that the rear terminals are *not accessible* during operation. The single wire connection may have high voltage while transmitting.**
- **Disconnect all antennas from the tuner during lightning storms.**
- **Always tune with low power (2-20 watts). Apply maximum power only after tuning up.**
- **Never exceed tuner specifications.**

1. Connect the MFJ-939 to the interface cable and connect the interface cable to the radio.
2. Check the radio instructions to verify that the radio can supply 750mA on the 12V line coming to the interface cable. If the radio can not supply 750mA then connect a 12-15VDC power source capable of supplying 750mA to the tuner.
3. Connect your transmitter to the TRANSMITTER connector using a 50-ohm coaxial cable.
4. Connect your coax-fed antenna to the ANTENNA connector using a 50-ohm coaxial cable, or connect your random wire to the ANTENNA connector through the supplied adaptor.
5. Connect your ground connection to the GROUND post.
6. Press the [POWER] button to turn on the MFJ-939 tuner.
7. Press the [ALT] button momentarily until there is one beep. One beep indicates that memory 1 is selected.
8. Key your transmitter to output a carrier of 2-20 watts CW, FM or AM.
9. Press and hold the [TUNE] button for one second to start the automatic tuning process. When completed, check to ensure an SWR of 1.5 or less has been achieved before increasing RF power.

Note: *If you have a tuning solution on one band and you then change bands and attempt to transmit a tuning signal, the previous tuning solution may be sufficiently severe such that no power is detected by the MFJ-939 (the MFJ-939 will tell you to increase power). When this occurs, simply bypass the MFJ-939 and then initiate a tune.*

10. You are ready to transmit with full power.

Note: *During the automatic tuning process, the tuner will make some noise. These are the relays switching at a very high rate and this is normal. Do not be alarmed.*

Note: *When the tuner power is OFF, the tuner is in bypass mode and RF from the transmitter goes directly to the antenna with no matching. The tuner also powers up in the bypass mode. When the tuner power is ON, pressing [TUNE] quickly places the tuner in bypass mode if desired, which is indicated by one beep.*

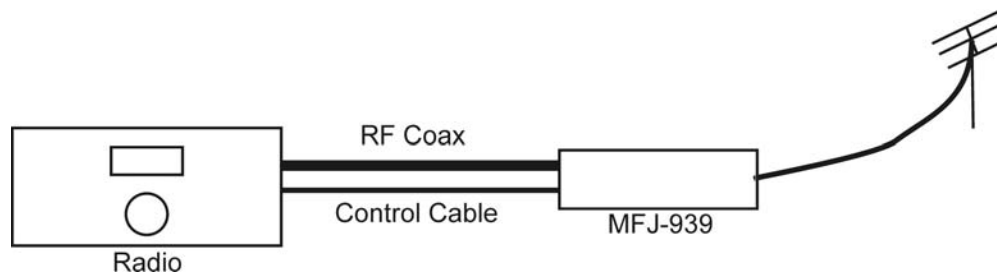

Figure 1 General Setup

Front Panel

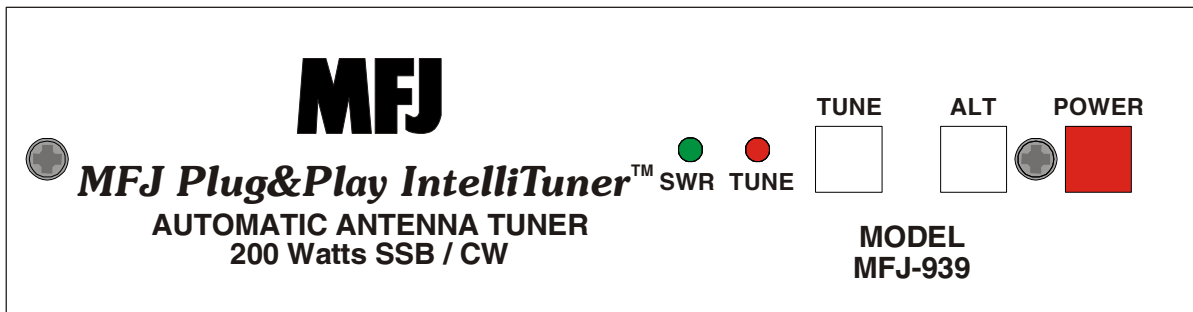

Figure 2 MFJ-939 Front Panel.

- SWR LED:** A green LED that illuminates when the SWR is 1.5 or less.
- TUNE LED:** A red LED that illuminates when the automatic tuning is in progress.
- TUNE Button:** Has three different functions based on the length of time you press and hold it before releasing.

Press [TUNE] quickly (less than 0.5 second) to bypass the tuner. One beep indicates bypass mode, where RF from the transmitter goes directly to the antenna with no matching. A second quick press toggles the tuner back to its last L/C setting, and the tuner responds with two beeps.

Press [TUNE] for 0.5 to 2 seconds to start the automatic tuning process. Tuning starts when [TUNE] is released after the 0.5-2 second hold-time. The transmitter must be keyed first with at least two watts of power. When the SWR is already below the target SWR, pressing [TUNE] will fine-tune the match for a lower SWR, if possible. When the automatic tuning is completed, a series of beeps indicates the tuned SWR where one beep indicates SWR of 1.5 or less, two beeps indicate SWR of 1.6 to 2.0, three beeps indicate SWR of 2.1 to 2.5, and four beeps indicate SWR of 2.6 to 3.0. For SWR above 3.0, “SWR” (di-di-dit di-dah-dah di-dah-dit) will be sent on CW.

Note: You can reverse the two functions above by pressing and holding the [TUNE] button for approximately 10 seconds. I.e., when the [TUNE] button is pressed and held for 10 seconds. You will hear two beeps. Now pressing [TUNE] momentarily starts the tuning process, and pressing and holding the [TUNE] button for 0.5-2 seconds puts the tuner into the bypass mode.

“StickyTune” allows for one-handed tuning operation. Normal tuning requires keying the transmitter with one hand and using the other hand to push the [TUNE] button to start the tuning process unless a transceiver interface cable is installed. When *StickyTune* is enabled, the tuning process starts automatically when the transmitter is keyed with at least two watts of power regardless of the SWR. This works in both automatic and semi-automatic modes. To toggle the *StickyTune* mode on and off, press and hold the [TUNE] button for two seconds. One beep indicates on and two beeps indicate off. Default is off.

Note: *StickyTune* resets to OFF when the power is cycled or after tuning.

ALT Button: Has two different functions based on the length of time you press and hold it before releasing. Press [ALT] quickly (less than one second) to select the primary memory bank to use. Press button to toggle between Memory 1 and Memory 2. One beep indicates Memory 1 and two beeps indicate Memory 2.

Press and hold [ALT] for one second to cycle among the four secondary memory banks of the current primary memory selected. The selected bank is indicated by a series of short beeps, where one beep indicates bank A, two beeps indicate bank B, three beeps indicate bank C, four beeps indicate bank D, and five beeps indicate antenna memory is OFF. See “Antenna Memory” on page 11.

Pressing the [ALT] button will switch the antenna or bank *only* when there is no RF power; also, the tuner setting for the selected antenna and bank, if available, is instantly restored from memory when enabled.

POWER Button: Used to turn the power on and off. When the power is off, the tuner is bypassed (straight through from TRANSMITTER to ANTENNA). When power is turned on, the tuner powers up bypassed, but will revert to the last stored matching values or begin tuning on application of RF power when the [TUNE] button is pressed – or if Automatic or *StickyTune* is enabled.

WARNING: Do not turn the power on and off rapidly, otherwise the tuning setting memory can be corrupted and the unit will have to be reset to factory defaults.

Note: When the tuner power is OFF, the tuner is bypassed and RF from the transmitter goes directly to the antenna with no matching.

Automatic/Semi-Automatic Tuning Mode

Pressing [TUNE] and [ALT] simultaneously toggles between automatic and semi-automatic tuning mode. One beep indicates automatic mode and two beeps indicate semi-automatic mode. In automatic mode, the tuning routine is automatically started when at least two watts of power is applied and the SWR is greater than 2.5. In semi-automatic mode, the tuning routine starts only when the [TUNE] button is pressed for 0.5 to 2 seconds.

Note: During the automatic tuning process, the tuner will make some noise. These are the relays switching at a very high rate and this is normal. Do not be alarmed.

BUTTON ACTION

- Press **POWER** in to turn power on, out to turn power off.
- Press **TUNE** less than 0.5 second to toggle bypass mode; press and hold for 0.5 to 2 seconds to start the tuning process; press and hold for more than two seconds to toggle the StickyTune on and off.
- Press **ALT** less than one second to toggle between memory 1 and memory 2; press and hold for more than one second to cycle through the 2 antenna memory banks.
- Press **TUNE** + **ALT** to toggle between automatic and semi-automatic mode.

Figure 3 Button Action

BACK PANEL

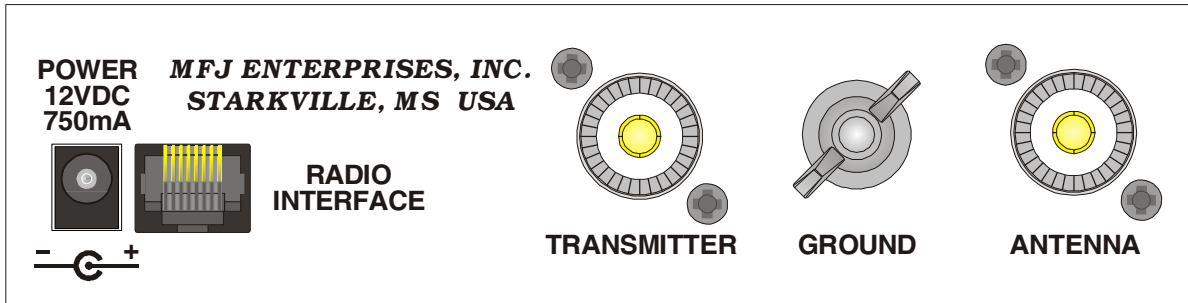

Figure 4 MFJ-939 Back Panel.

- Power:** This jack accepts a standard 2.1 × 5.5 mm coaxial plug with positive center and negative sleeve. The tuner requires 12-15 volts DC at up to 750 mA. The use of a regulated supply is not mandatory but is recommended for best performance. An optional 12 volts DC 1.5 amp power supply, the MFJ-1316, is available from MFJ Enterprises, Inc. **WARNING: Do not apply voltages greater than 18 volts to this unit, or permanent damage may result.**

Note: When the tuner power is OFF, the tuner is bypassed and RF from the transmitter goes directly to the antenna with no matching. When turned on, the tuner powers up in bypass mode.

- Radio Interface:** An 8-pin modular (RJ-45) connector for connecting to the tuner interface connector of compatible radios. Most radios provide +13.8 VDC power through its tuner interface connector. If separate power supplies are used to power the MFJ-939, the MFJ-939 should be powered on first (both LEDs blink once) and then turn on the radio, so the radio knows an external tuner is attached. The radio will disable its internal tuner, if it has one, and use the external tuner.

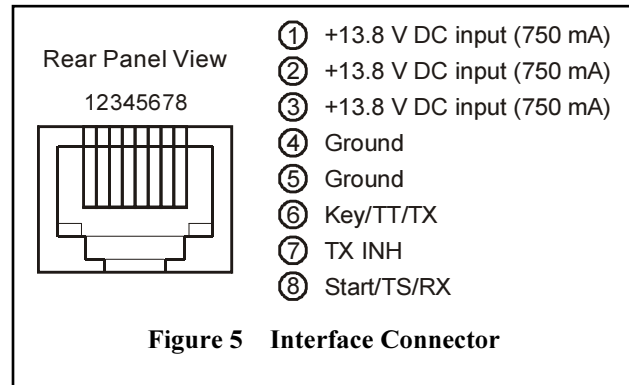

Figure 5 Interface Connector

The Radio Interface works with radios that are compatible with Alinco EDX-2, Icom AH-3 and AH-4, Kenwood AT-300, and Yaesu FC-30, FH-1 and FH-2. When connected to a compatible radio, simply press the [TUNER] or [AT] button on the radio; for FH-1 or FH-2 compatible Yaesu, press the [TUNE] button *on the tuner* to start the automatic tuning process. The radio will automatically switch to CW mode, transmit a low power (typically 10-30 watts) carrier, and start the tuning process. Once the automatic tuning is completed, the radio will return to its previous mode and power setting.

WARNING: Make sure the +13.8 volts connection on the radio's tuner port is capable of supplying the 750 mA of current required by the MFJ-939.

- Transmitter:** SO-239 connector for coax cable from transmitter or transceiver
- Ground:** Wing-nut terminal for RF ground wire connection.
- Antenna:** SO-239 connector for coax cable from antenna.

Note: To use a WIRE on the Antenna connector, be sure to use the enclosed adaptor.

Installation

WARNING

- **Never operate the tuner with its cover removed. Contact with the components inside the tuner while transmitting will result in painful RF burns.**
- **Locate the tuner so that the rear terminals are *not accessible* during operation. A single wire connection may have high voltage while transmitting.**
- **Disconnect the antenna from the tuner during lightning storms.**
- **Always tune with low power (2-20 watts). Apply maximum power only after tuning up.**
- **Never exceed tuner specifications.**

1. Place the tuner in a convenient location at the operating position. When using a random wire antenna the feed through insulators may have high RF voltages. These voltages can cause serious RF burns if the terminals are touched when transmitting. **Be sure to locate the tuner so these terminals cannot accidentally be contacted during operation.**
2. Install the tuner between the transmitter and the antenna. Use a 50-ohm coaxial cable (such as RG-58) to connect the transmitter to the connector marked TRANSMITTER on the rear of the tuner. See Figure 1 on page 3.
3. Connect the antenna(s) to the tuner as follows:
 - Coaxial feedlines to the SO-239 connectors labeled ANTENNA.
 - Random wire to the ANTENNA connector on the back of the unit using the enclosed adaptor.

Note: *Route all random wire antennas safely to prevent RF burn hazard.*

4. A GROUND post is provided for an RF ground connection. See “Grounding Hints” on page 25.
5. Connect a 12 to 15 VDC power source to the input jack labeled POWER if your radio is not capable of supplying 750mA to the tuner. See your radio operations manual.

General Tuner Setup and Cabling

The MFJ-939 comes with the interface cable and the jumpers preset to allow for a quick “Plug and Play” setup.

- 1 With the radio off connect the interface cable to the radio and MFJ-939.
- 2 Connect the antenna to the Antenna coax connector as listed on page 7.
- 3 Connect the RF line from the radio coax connector to the MFJ-939 Radio coax connector as listed on page 7.
- 4 Ground the unit. See the Grounding Hints section on page 25.
- 5 Turn on the tuner first then the radio.
- 6 Follow the radio instruction manual for setting up the operation of an external tuner. See the Operation, Radio Interface, and Connection information sections for additional details for the radios listed below.

As the station changes the tuner can be reconfigured as listed in the Interface section of each model to function with other radios by replacing the interconnect cable and changing jumpers in the tuner.

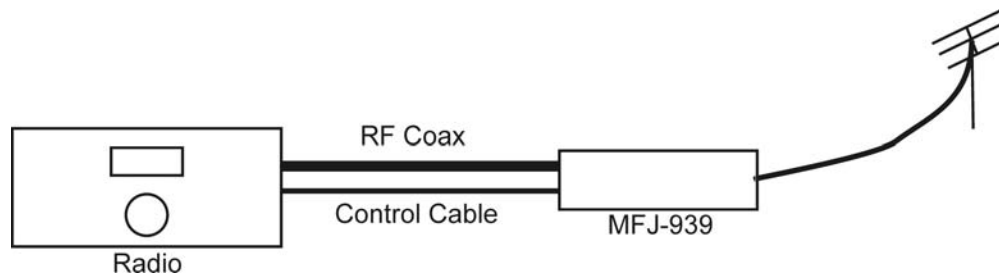

Figure 6 General Setup

Modification to Change Radio Model

Changing the MFJ-939 to use with another model of radio is not difficult to do. For the radio model you are changing to obtain the proper interface cable and change the jumpers in the tuner to the positions needed for the new radio. See the section Radio Interface and Connections under the new radio you are changing to for interface model and jumper settings.

OPERATION

MFJ-939I Icom

IC-706, IC-707, IC-718, IC-725, IC-728, IC-736, IC-738, IC-746, IC-756, IC-7000

Operation

The operation of the MFJ-939I tuner is similar to the operation of the AH-3 or AH-4 described in the Icom radio's operating manual.

1. Push and hold the [TUNER] button on the radio for one or two seconds to initiate automatic tuning process. The radio will automatically switch to CW mode, transmit a 10-watt carrier, and start the tuning process. When the tuning process is completed, the radio will stop transmitting, return to its previous mode and power setting.
2. Push the [TUNER] button on the radio quickly to bypass the tuner or to cancel tuning in progress.

Note the [TUNE] button on the tuner will also key the Icom radio interface.

Icom Radio Interface

The MFJ-5114I radio interface allows users of AH-3 or AH-4 compatible Icom transceivers to connect to the MFJ-939 Plug&Play IntelliTuner™ Automatic Antenna Tuner. With this interface, control signals are connected between the radio and the tuner. The operator can then control the tuner with a single push of the [TUNER] button on the front panel of the radio. Supported Icom radios are IC-706, IC-707, IC-718, IC-725, IC-728, IC-736, IC-738, IC-746, IC-756, IC-7000, and any Icom radio that supports the Icom AH-3 or AH-4 tuner.

Connections

Jumper	Setting
JP2	I
JP4	REMOVE
CABLE	MFJ-5114I

Table 1 Icom

The MFJ-5114I interface cable provides control signals between an Icom radio and the MFJ automatic tuner. Supported Icom radios are IC-706, IC-707, IC-718, IC-725, IC-728, IC-736, IC-738, IC-746, IC-756, IC-7000, and any Icom radio that supports the Icom AH-3 or AH-4 tuner. Push and hold the radio's [TUNER] button for two seconds to start the tuning process. Push [TUNER] quickly to bypass the tuner. **Make sure jumper JP4 is removed for IC-7000**



- ① Pin 1 (Key) connects to pin 6 of Radio Interface Plug.
- ② Pin 2 (Start) connects to pin 8 of Radio Interface Plug.
- ③ Pin 3 (+13.8V) connects to pins 2 and 3 of Radio Interface Plug.
- ④ Pin 4 (Ground) connects to pins 4 and 5 of Radio Interface Plug.

Figure 7 Icom Interface Cable.

1. Turn the tuner off. Set jumper JP2 to the “I” position.
2. **For IC-7000, make sure jumper JP4 inside the MFJ-939 is removed.**
3. Insert the 8-pin modular plug into the tuner’s RADIO INTERFACE jack.
4. Important: *Make sure the DC power to the radio has been turned off. The radio does not fuse the DC power to the tuner, and damage to the radio can occur if the interface’s power connection comes in contact with ground.*
5. Connect the 4-pin Molex connector to the mating 4-pin Molex connector, marked as TUNER, on the back of the Icom radio.
6. Push the [POWER] button on the tuner to the *in* position and then power on the radio.
7. Some Icom radios, such as the IC-706, automatically check to see if an external antenna tuner is connected during power on. For other Icom radios, such as the IC-718, the Tuner Type menu in the radio menu system must be enabled. Refer to your radio operating manual for accessing the menu system and preparing the AH-4 antenna tuner operation. Use IC-718 as an example:
 - a. Push [PWR] for 1 second to turn power off.
 - b. While pushing and holding [SET], push [PWR] to turn power on.
 - c. Push [UP] or [DN] one or more times to select TUNER.
 - d. Rotate the Main Dial to select “4” for AH-4 antenna tuner.
 - e. Push [PWR] for 1 second to turn power off.
 - f. Push [PWR] to turn power on again.

MFJ-939K Kenwood

TS-50S, TS-450S, TS-480HX, TS-570S, TS-590, TS-690S, TS-850S, TS-870S, TS-2000

Operation

The operation of the MFJ-939K radio interface is similar to the operation of the AT-300 described in the Kenwood radio's operating manual.

1. Press and hold the [AT TUNE] button on the radio for one second to initiate automatic tuning process. The radio will automatically switch to CW mode, transmit a 10-watt carrier, and start the tuning process. When the tuning process is completed, the radio will stop transmitting, return to its previous mode and power setting.
2. Press the [AT TUNE] button on the radio quickly to bypass the tuner (some Kenwood radios, such as the TS-690S, do not have this bypass function) or to cancel tuning in progress.

Note the [TUNE] button on the tuner will not operate the Kenwood radio interface.

Note: The TS-480HX will automatically reduce its TX power to 100 watts maximum (25 watts AM) when the radio interface is used.

Note: For the TS-2000, use the ANT 1 and AT connectors on the radio to connect an external antenna tuner. If the external tuner is connected to the ANT 2 connector on the radio, the external tuner will not function with the radio interface.

Kenwood Radio Interface

The MFJ-5114K radio interface allows users of AT-300 compatible Kenwood transceivers to connect to the MFJ-939 Plug&Play IntelliTuner™ Automatic Antenna Tuner. With this interface, control signals are connected between the radio and the tuner. The operator can then control the tuner with a single push of the [AT TUNE] button on the front panel of the radio. Supported Kenwood radios are TS-50S, TS-450S, TS-480HX, TS-570S, TS-690S, TS-850S, TS-870S, TS-2000, and any Kenwood radio that supports the Kenwood AT-300 tuner.

Connections

Jumper	Setting
JP2	K
JP4	INSTALLED
CABLE	MFJ-5114K

Table 2 Kenwood

Push and hold the radio's [AT TUNE] button for one second to start the tuning process.

Push the [AT TUNE] quickly to bypass the tuner or to cancel tuning in progress. Make sure jumper JP4 is installed.

Note: The TS-480HX will automatically reduce its TX power to 100 watts maximum (25 watts AM) when the radio interface is used.

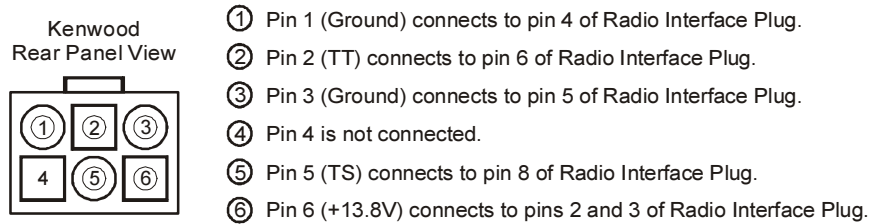

Figure 8 Kenwood Interface Cable

1. Turn the tuner off. Set jumper JP2 to the “K” position.
 2. Make sure jumper JP4 inside the MFJ-939 is installed.
 3. Insert the 8-pin modular plug into the tuner’s RADIO INTERFACE jack.
 4. **Important:** *Make sure the DC power to the radio has been turned off. The radio does not fuse the DC power to the tuner, and damage to the radio can occur if the interface’s power connection comes in contact with ground.*
 5. Connect the 6-pin Molex connector to the mating 6-pin Molex connector, marked as AT or ACC, on the back of the Kenwood radio.
1. Push the [POWER] button on the tuner to the *in* position and then power on the radio.
 2. Some Kenwood radios automatically check to see if an external antenna tuner is connected during power on. For other Kenwood radios, such as the TS-450S and the TS-690S, the External Antenna Tuner menu in the radio menu system must be enabled. Refer to your radio’s operating manual for accessing the menu system and preparing the AT-300 external antenna tuner operation. Use TS-450S and TS-690S as an example:
 - a. Press and hold the [ENT] key while turning the power on.
 - b. Rotate the [M.CH/VFO CH] control to select menu number 01 on the display.
 - c. Press the [UP] or [DOWN] key to change the setting to “ON.”
 - d. Press the [CLR] key to return to normal operation.

MFJ-939Y Yaesu

Yaesu FT-100, FT-450, FT-847, FT-857, FT-897, FT-950

Operation for FT-100

The operation of the MFJ-939Y radio interface is similar to the operation of the FC-20 described in the Yaesu radio operating manual.

1. Press the [FUNC] key, as needed, to recall Operating Function Row 7 [MTR, TUN, PRO, VOX].
2. Press the [B](TUN) key on the radio for ½ second to turn the external tuner function on; the “TUN” icon will appear bolded in the radio’s display.
3. Press and hold the [B](TUN) key on the radio to begin automatic tuning. The radio will automatically transmit a low-power carrier and start the tuning process. Press the [B](TUN) key again to cancel tuning in progress. When tuning is completed, the radio will stop transmitting and you will be ready for operation on this frequency.

Note the [TUNE] button on the tuner will not operate the MFJ-5114Y Yaesu radio interface.

Operation for FT-450

The operation of the MFJ-5114Y radio interface is similar to the operation of the FC-30/-40 described in the Yaesu radio operating manual.

1. Press the (TUNE) button on the radio briefly to enable the external tuner function. The “TUNER” icon will appear in the radio’s display. If the radio frequency is out of the amateur band, the “TUNER” icon will not appear.
2. Press and hold the (TUNE) button on the radio for one second to begin automatic tuning. The radio will automatically transmit a low-power carrier and start the tuning process. The “TUNER” icon will blink while tuning is in progress. Press and hold the (TUNE) button on the radio for one second while tuning is in progress to cancel the automatic tuning.
3. When tuning is completed, the radio will stop transmitting and you will be ready for operation on this frequency.

Note the [TUNE] button on the tuner will not operate the MFJ-5114Y Yaesu radio interface.

Operation for FT-857 or FT-897

The operation of the MFJ-5114Y radio interface is similar to the operation of the FC-30 described in the Yaesu radio operating manual.

1. Press the [FUNC] or [F] key, then rotate the [SELECT] or [MEM/VFO CH] knob to recall Multi Function Row “k” [TUNE, DOWN, UP].
2. Press the [A](TUNE) key on the radio to turn the external tuner function on; the “TUNE” or “TUNR” icon will appear in the radio’s display.
3. Press and hold the [A](TUNE) key on the radio to begin automatic tuning. The radio will automatically transmit a low-power carrier and start the tuning process. Press the [A](TUNE) key again to cancel tuning in progress. When tuning is completed, the radio will stop transmitting and you will be ready for operation on this frequency.

Note the [TUNE] button on the tuner will not operate the MFJ-5114Y Yaesu radio interface.

Operation for FT-950

The operation of the MFJ-5114Y radio interface is similar to the operation of the FC-40 described in the Yaesu radio operating manual.

1. Press the (TUNE) button on the radio briefly to enable the external tuner function. The “TUNER” icon will appear in the radio’s display.
2. Press and hold the (TUNE) button on the radio for one second to begin automatic tuning. The radio will automatically transmit a low-power carrier and start the tuning process. The “TUNER” icon will blink while tuning is in progress. Press the (TUNE) button on the radio while tuning is in progress to cancel the automatic tuning.

Note the [TUNE] button on the tuner will not operate the MFJ-5114Y Yaesu radio interface.

Note: The FT-950 will not start automatic tuning when the SWR is greater than approximately 5:1, indicated by both “TUNER” and “HI-SWR” icons blinking once when the (TUNE) button on the radio is pressed and held for one second.

For operation of compatible radios not listed above follow the instructions in the radio operations manual on the external tuner use like the FC-20, FC-30, or FC-40. They are similar to the radios listed above.

Yaesu Radio Interface MFJ-5114Y

The MFJ-5114Y radio interface allows users of FC-30 compatible Yaesu transceivers to connect to the MFJ-939 Plug&Play IntelliTuner™ Automatic Antenna Tuners. With this interface, control signals are connected between the radio and the tuner. The operator can then control the tuner with a single push of the (TUNE) key on the front panel of the radio. Supported Yaesu radios are FT-100, FT-450, FT-857, FT-897, FT-950, and any Yaesu radio that supports the Yaesu FC-30 tuner.

Connections

Jumper	Setting
JP1	Y
JP4	INSTALLED
CABLE	MFJ-5114Y

Table 3 Yaesu

Push and hold the radio’s (TUN) or (TUNE) key to start the tuning process.

Make sure jumper JP4 is installed.

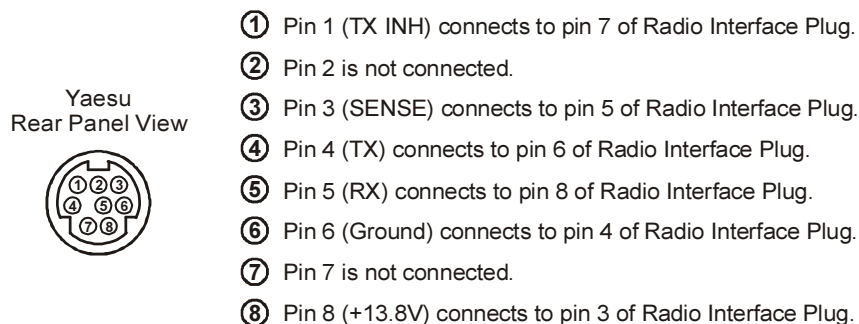

Figure 9 Yaesu Interface Cable (FT-100/-450/-857/-897/-950).

Connections for the FT-100

1. Turn the tuner off. Set jumper JP2 to the “Y” position.
2. Make sure jumper JP4 inside the MFJ-939 is installed.
3. Before connecting the MFJ-5114Y to your radio, follow the instructions in the radio’s manual for installing the FC-20 automatic antenna tuner.
 - a. Press and hold the [FUNC] key for ½ second to activate the Menu mode.
 - b. Rotate the [SELECT] knob to recall Menu #61 [TUNER/ATAS], and then rotate the Main Dial to change the setting to “tunEr.”
 - c. Press the [FUNC] key momentarily to save the new setting and exit to normal operation.
 - d. Turn the FT-100’s power off, then on again, to re-initialize the radio regarding the tuner status.
4. Turn the radio off. Insert the 8-pin modular plug into the tuner’s RADIO INTERFACE jack.
5. **Important:** *Make sure the DC power to the radio has been turned off. The radio does not fuse the DC power to the tuner, and damage to the radio can occur if the interface’s power connection comes in contact with ground.*
6. Connect the 8-pin mini DIN connector to the mating 8-pin mini DIN connector at the end of the BAND DATA cable pigtail on the back of the radio.
7. Push the [POWER] button on the tuner to the *in* position and then power on the radio.

Connections for FT-450

1. Turn the tuner off. Set jumper JP2 to the “Y” position.
2. Make sure jumper JP4 inside the MFJ-939 is installed.
3. Before connecting the MFJ-5114Y to your radio, follow the instructions in the radio’s manual for installing the FC-30/-40 automatic antenna tuner.
 - a. Press and hold the [F] button for one second to enter the Menu mode. The “MENU” icon will appear in the display.
 - b. Rotate the [DSP/SEL] knob to select Menu item [TUNER (TUNER/ATAS)].
 - c. Press the [DSP/SEL] knob to enable this selected Menu item.
 - d. Rotate the [DSP/SEL] knob to change the setting to “EXT ATU.”
 - e. Press and hold the [F] button for one second to save the new setting and exit to normal operation.
4. Turn the radio off. Insert the 8-pin modular plug into the tuner’s RADIO INTERFACE jack.
5. **Important:** *Make sure the DC power to the radio has been turned off. The radio does not fuse the DC power to the tuner, and damage to the radio can occur if the interface’s power connection comes in contact with ground.*
6. Connect the 8-pin mini DIN connector to the mating 8-pin mini DIN connector, marked as TUNER, on the back of the radio.
7. Push the [POWER] button on the tuner to the *in* position and then power on the radio.

Connections for FT-857 or FT-897

1. Turn the tuner off. Set jumper JP2 to the “Y” position.

2. Make sure jumper JP4 inside the MFJ-939 is installed.
3. Before connecting the MFJ-5114Y to your radio, follow the instructions in the radio's manual for installing the FC-30 automatic antenna tuner. For the following, use the [FUNC] key and the [SELECT] knob on the FT-857, or use the [F] key and the [MEM/VFO CH] knob on the FT-897.
 - a. Press and hold the [FUNC] or [F] key for one second to activate the Menu mode.
 - b. Rotate the [SELECT] or [MEM/VFO CH] knob to recall Menu Mode #001 [EXT MENU], and then rotate the Main Dial to change the setting to "ON" to enable extended Menu Mode.
 - c. Rotate the [SELECT] or [MEM/VFO CH] knob to recall Menu Mode #020 [CAT/LIN/TUN], and then rotate the Main Dial to change the setting to "TUNER."
 - d. Press and hold the [FUNC] or [F] key for one second to save the new setting and exit to normal operation.
 - e. Turn the radio off, then on again. Do not connect the MFJ-5114Y before changing the Menu Mode #020 [CAT/LIN/TUN].
 - f. Press and hold the [FUNC] or [F] key for one second to activate the Menu mode.
 - g. Rotate the [SELECT] or [MEM/VFO CH] knob to recall Menu Mode #085 [TUNER/ATAS], and then rotate the Main Dial to change the setting to "TUNER."
 - h. Press and hold the [FUNC] or [F] key for one second to save the new settings and exit to normal operation.
4. Turn the radio off. Insert the 8-pin modular plug into the tuner's RADIO INTERFACE jack.
5. **Important:** *Make sure the DC power to the radio has been turned off. The radio does not fuse the DC power to the tuner, and damage to the radio can occur if the interface's power connection comes in contact with ground.*
6. Connect the 8-pin mini DIN connector to the mating 8-pin mini DIN connector, marked as CAT/LINEAR, on the back of the radio.
7. Push the [POWER] button on the tuner to the *in* position and then power on the radio.

Connections for FT-950

1. Turn the tuner off. Set jumper JP2 to the "Y" position.
2. Make sure jumper JP4 inside the MFJ-939 is installed.
3. Before connecting the MFJ-5114Y to your radio, follow the instructions in the radio's manual for installing the FC-40 automatic antenna tuner.
 - a. Press the [MENU] button momentarily to enter the Menu mode.
 - b. Rotate the [SELECT] knob to select Menu item [110 TGEN EXT TUN]. Press the [SELECT] knob momentarily to toggle the display between [110 TGEN] and [EXT TUN].
 - c. Rotate the [CLAR/VFO-B] knob to change the setting to "Etu" to enable the External Tuner.
 - d. Press and hold the [MENU] button for one second to save the new setting and exit to normal operation. If you only *momentarily* press the [MENU] button, the new setting will not be retained.
4. Turn the radio off. Insert the 8-pin modular plug into the tuner's RADIO INTERFACE jack.

5. **Important:** *Make sure the DC power to the radio has been turned off. The radio does not fuse the DC power to the tuner, and damage to the radio can occur if the interface's power connection comes in contact with ground.*
6. Connect the 8-pin mini DIN connector to the mating 8-pin mini DIN connector, marked as TUNER, on the back of the radio.
7. Push the [POWER] button on the tuner to the *in* position and then power on the radio.
3. When tuning is completed, the radio will stop transmitting and you will be ready for operation on this frequency.

Note the [TUNE] button on the tuner will not operate the MFJ-5114Y Yaesu radio interface.

MFJ-939Y3 FT-1000MP FT-2000 FT-9000

Operation for FT-1000MP series of radios

The transceiver is controlled by the MFJ-939. To operate:

1. Press the [TUNE] button on the MFJ-939 for ½-2 seconds to initiate the tuning process. The radio will automatically transmit a low-power carrier and start the tuning process. When tuning is completed, the radio will stop transmitting and you will be ready for operation on this frequency.

Operation for FT-2000 series of radios

The transceiver is controlled by the MFJ-939. To operate:

1. Press the [TUNE] button on the MFJ-939 for ½-2 seconds to initiate the tuning process. The radio will automatically transmit a low-power carrier and start the tuning process. When tuning is completed, the radio will stop transmitting and you will be ready for operation on this frequency.

Operation for FTdx-9000 series of radios

The transceiver is controlled by the MFJ-939. To operate:

1. Press the [TUNE] button on the MFJ-939 for ½-2 seconds to initiate the tuning process. The radio will automatically transmit a low-power carrier and start the tuning process. When tuning is completed, the radio will stop transmitting and you will be ready for operation on this frequency.

Yaesu Radio Interface MFJ-5114Y3

The MFJ-5114Y3 radio interface allows users of Yaesu FT-1000MP series, FT-2000 series, and FTDX-9000 series transceivers to connect to the MFJ-939 *Plug&Play IntelliTuner™* Automatic Antenna Tuner. With this interface, control signals are connected between the radio and the tuner. With this cable the operator can control the tuner and radio with a single push of the [TUNE] button on the front panel of the MFJ-939.

Connections

Jumper	Setting
JP2	I
JP4	Does Not Care
CABLE	MFJ-5114Y3

Table 4 Y3 Interface

The MFJ-5114Y3 interface provides control signals between a Yaesu radio and the MFJ automatic tuner. Supported Yaesu radios are FT-1000MP, FT-1000MP MKV, FT-1000MP MKV Field, FT-2000, FTDX-9000, and any Yaesu radio compatible with the Yaesu FH-1 or FH-2 Remote Control. This cable plugs into the REMOTE jack on the rear panel of the Yaesu radios, and keys the Yaesu radios in the CW tune mode whenever the MFJ-939's [TUNE] button is pushed. MFJ recommends that the Yaesu CW tune setting be set to 10 watts (Yaesu MP menu selection 4-3) during the tune process when an amplifier is not used. For best accuracy when an amplifier is used, MFJ recommends that the Yaesu CW tune setting be set to 50 watts for 100-watt transceivers and 75 watts for 200-watt MKV transceivers during the tune process. If a FH-1 or FH-2 keypad is also used, both the FH-1/FH-2 and the radio control cable may be plugged in parallel using a 3.5-mm headphone splitter (mono or stereo is fine).

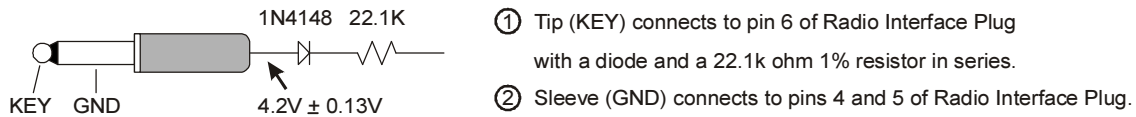

Figure 10 Yaesu Interface Cable (1000MP/2000/9000 series).

Connections for FT-1000MP series of radios

1. Turn the tuner off. Set jumper JP2 to the “I” position.
2. Before connecting the MFJ-5114Y3 to your radio, set the maximum TUNE power of the radio as follows:
 - a. On your transceiver, enter the Menu mode by pressing and holding the [FAST] key and then pressing [ENT].
 - b. Rotate the [MEM/VFO CH] knob until you see menu 4-3 on the transceiver’s CH display.
 - c. Rotate the [MAIN VFO] knob to select 50 for 100-watt radios (FT-1000MP/MP Field) or 75 for the FT-1000MP MKV when an amplifier will be used. This gives the best SWR accuracy, which may be important for solid-state amplifiers. When an amplifier is not used, the setting can be set at 10 for all transceivers.
 - d. Press [ENT] to exit the Menu mode.
3. Insert the 8-pin modular plug into the MFJ-939 RADIO INTERFACE jack.
4. Connect the 3.5-mm mono plug on the MFJ-5114Y3 to the REMOTE jack on the rear panel of the transceiver.
5. Connect a 12V 750 mA DC source to the MFJ-939.
6. Push the [POWER] button on the MFJ-939 to the *in* position. The radio may be powered on either before or after the tuner is powered on.

Connections for FT-2000 series of radios

1. Turn the tuner off. Set jumper JP2 to the “I” position.
2. Before connecting the MFJ-5114Y3 to your radio, set the maximum TUNE power of the radio as follows:
 - a. On your transceiver, enter the Menu mode by pressing the [MENU] key momentarily.
 - b. Rotate the Main Tuning Dial knob until you see menu item [145 tGEn TUN PWR] on the transceiver’s display.
 - c. Rotate the [SUB VFO-B] knob to select 20 watts for best SWR accuracy. For the FT-2000D, we recommend that this be set to 50 watts if the user normally operates at 100 watts output power (when power is turned down to 100 watts, the TUNE power will reduce to 25 watts). If the operator normally has his FT-2000D set for the full 200 watts, then this should be set to 20 watts.
 - d. Press and hold in the [MENU] key for two seconds to save the new setting and exit to normal operation. If you press the [MENU] key momentarily, the new setting will *not* be saved.
3. Insert the 8-pin modular plug into the MFJ-939 RADIO INTERFACE jack.
4. Connect the 3.5-mm mono plug on the MFJ-5114Y3 to the REM (REMOTE) jack on the rear panel of the transceiver.

5. Connect a 12V 750 mA DC source to the MFJ-939.
6. Push the [POWER] button on the MFJ-939 to the *in* position. The radio may be powered on either before or after the tuner is powered on.

Connections for FTDX-9000 series of radios

1. Turn the tuner off. Set jumper JP2 to the “I” position.
2. Before connecting the MFJ-5114Y3 to your radio, set the maximum TUNE power of the radio as follows:
 - a. On your transceiver, enter the Menu mode by pressing the [MNU] key momentarily.
 - b. Rotate the Main Tuning Dial knob until you see menu item [157 EXT AMP TUNING PWR] on the transceiver’s display.
 - c. Rotate the [CLAR/VFO-B] knob to select 50 watts for best SWR accuracy. The TUNE power varies with the output power level control setting, so ensure that the TUNE power is somewhere between 20-50 watts.
 - d. Press and hold in the [MNU] key for two seconds to save the new setting and exit to normal operation. If you press the [MNU] key momentarily, the new setting will not be saved.
3. Insert the 8-pin modular plug into the MFJ-939 RADIO INTERFACE jack.
4. Connect the 3.5-mm mono plug on the MFJ-5114Y3 to the REMOTE jack on the rear panel of the transceiver.
5. Connect a 12V 750 mA DC source to the MFJ-939.
6. Push the [POWER] button on the MFJ-939 to the *in* position. The radio may be powered on either before or after the tuner is powered on.

MFJ-939Y4 FT-2000

Operation for FT-2000 series of radios

The transceiver is controlled by the MFJ-939. To operate:

1. Press the [TUNE] button on the MFJ-939 for ½-2 seconds to initiate the tuning process. The radio will automatically transmit a low-power carrier and start the tuning process. When tuning is completed, the radio will stop transmitting and you will be ready for operation on this frequency.

Yaesu Radio Interface MFJ-5114Y4

The FT-2000 series radio has a TX REQ input on the back that can be used in lieu of the REM (REMOTE) input. If this option is chosen, you must use the MFJ-5114Y4 radio interface cable. With this interface, control signals are connected between the radio and the tuner. With this cable the operator can control the tuner and radio with a single push of the [TUNE] button on the front panel of the MFJ-939.

Connections for FT-2000 series of radios

Jumper	Setting
JP2	I
JP4	Does Not Care
CABLE	MFJ-5114Y4

Table 5 Y4 Interface

The MFJ-5114Y4 interface provides TX REQ input control signals between the Yaesu FT-2000 and FT-2000D radios and the MFJ automatic tuner. This cable plugs into the TX REQ RCA jack on the rear panel of these Yaesu radios, and keys the Yaesu radios in the CW tune mode whenever the MFJ-939's [TUNE] button is pushed. MFJ recommends that the Yaesu tune power setting be set to 20 watts (Yaesu menu 145 tGEn TUN PWR) during the tune process

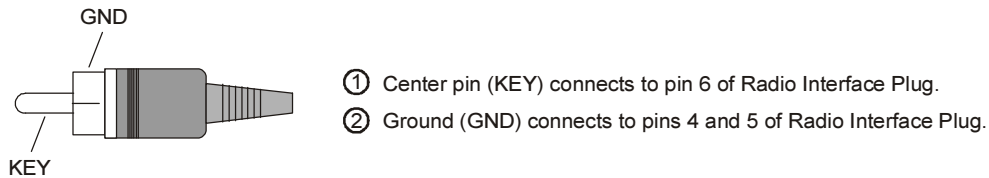

Figure 11 Yaesu Interface Cable (FT-2000 series)

1. Turn the tuner off. Set jumper JP2 to the “I” position.
2. Before connecting the MFJ-5114Y4 to your radio, set the maximum TUNE power of the radio as follows:
 - a. On your transceiver, enter the Menu mode by pressing the [MENU] key momentarily.
 - b. Rotate the Main Tuning Dial knob until you see menu item [145 tGEn TUN PWR] on the transceiver's display.
 - c. Rotate the [SUB VFO-B] knob to select 20 watts for best SWR accuracy. For the FT-2000D, we recommend that this be set to 50 watts if the user normally operates at 100 watts output power (when power is turned down to 100 watts, the TUNE power will reduce to 25 watts). If the operator normally has his FT-2000D set for the full 200 watts, then this should be set to 20 watts.

- d. Press and hold in the [MENU] key for two seconds to save the new setting and exit to normal operation. If you press the [MENU] key momentarily, the new setting will *not* be saved.
3. Insert the 8-pin modular plug into the MFJ-939 RADIO INTERFACE jack.
4. Connect the RCA plug on the MFJ-5114Y4 to the TX REQ jack on the rear panel of the transceiver.
5. Connect a 12V 750 mA DC source to the MFJ-939.
6. Push the [POWER] button on the MFJ-939 to the *in* position. The radio may be powered on either before or after the tuner is powered on.

Modification For Use With Alinco

Alinco Radio Interface

Any of the MFJ-939 series can be modified for use with Alinco radios by changing the jumpers and replacing the interface cable.

The MFJ-5114A radio interface allows users of EDX-2 compatible Alinco transceivers to connect to the MFJ-939 *Plug&Play IntelliTuner™* Automatic Antenna Tuner. With this interface, control signals are connected between the radio and the tuner. The operator can then control the tuner with a single push of the [TUNE] button on the front panel of the radio. Supported Alinco radios are DX-70, DX-77, DX-701, DX-801, and any Alinco radio that supports the Alinco EDX-2 tuner.

Connections

Jumper	Setting
JP2	I
JP4	Does Not Care
Cable	MFJ-5114A

Table 6 Alinco

Press the radio's [TUNE] button to start the tuning process; for DX-70 press [FUNC] then [TUNE].

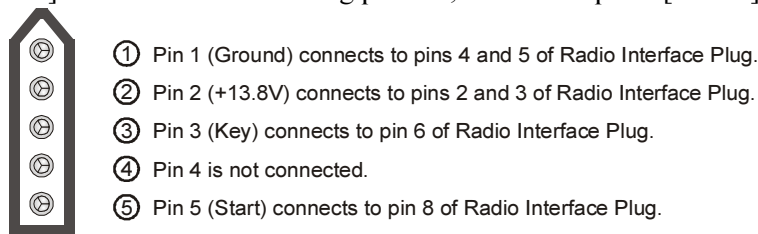

Figure 12 Alinco Interface Cable.

3. Turn the tuner off. Set jumper JP2 to the “I” position.
4. Insert the 8-pin modular plug into the tuner's RADIO INTERFACE jack.
5. **Important:** *Make sure the DC power to the radio has been turned off. The radio does not fuse the DC power to the tuner, and damage to the radio can occur if the interface's power connection comes in contact with ground.*
6. Connect the 5-pin Molex connector to the mating 5-pin Molex connector, marked as ACC, on the back of the Alinco radio.
7. Push the [POWER] button on the tuner to the *in* position and then power on the radio.

Operation

The operation of the MFJ-939 tuner modified for use with Alinco radios is similar to the operation of the EDX-2 described in the Alinco operating manual.

1. Push the [TUNE] button on the radio to initiate automatic tuning process; for DX-70 press [FUNC] then [TUNE]. The radio will automatically switch to CW mode, transmit a 10-watt carrier, and start the tuning process. “TUNE” appears in the radio’s LCD while tuning; do not change the frequency or mode while tuning. When the tuning process is completed, the radio will stop transmitting, return to its previous mode and power setting; “TUNE” disappears.

Note the [TUNE] button on the tuner will also key the Alinco radio interface.

Miscellaneous

ANTENNA MEMORY

The “memory resolution” is the width of frequency spectrum that the tuner recognizes as being the same as a tuned frequency already in memory. The memory resolution is approximately 0.1 percent of the lower frequency of each amateur band. For example, the memory resolution on the 40-meter band (7000 to 7300 kHz) is 7 kHz; if the tuner has memorized a setting for 7050 kHz, it will automatically call up this setting for any frequency from 7047 to 7053 kHz. Memory resolution is smaller at lower frequency to accommodate the higher antenna Q and larger at higher frequency where the antenna Q is lower. The memory resolutions for the HF amateur bands 160 through 10 meters are:

Meter	Frequency Range (kHz)	Memory Resolution (kHz)
160	1800 – 2000	2
75/80	3500 – 4000	4
60	5330.5, 5346.5, 5366.5, 5371.5 and 5403.5	5 memory locations
40	7000 – 7300	7
30	10100 – 10150	10
20	14000 – 14350	14
17	18068 – 18168	18
15	21000 – 21450	21
12	24890 – 24990	25
10	28000 – 29700	28

Table 7 Memory Resolution

The memory resolution for non-amateur frequency bands between 160 and 10 meters is approximately 0.2 percent of the lower frequency of each band. There are two primary memory banks, each with four secondary memory banks. Each secondary memory bank has 2500 memory locations. Tuner settings are stored in memory separately in primary memory 1 and primary memory 2. This provides memory for up to eight different antennas. See “ALT Button” on page 5. Defaults are memory banks 1A and 2A ON.

INTELLITUNE™ ALGORITHM

When the tuner cannot find an appropriate setting in its memory, it begins its calculation function. It measures the complex impedance of the antenna (load) at the transmitting frequency, then it calculates the LC components needed for a match. Then it fine-tunes the components for minimum SWR. If for any reason the tuner cannot calculate the load impedance, it proceeds to yet another method of calculation.

LC Limits

The upper limits of inductance (L) and capacitance (C) are factory-limited according to frequency and maximum power rating; i.e., higher frequencies need less inductance and less capacitance when the L-network is properly tuned. These limits are built into the MFJ-939 to prevent matching of extreme load impedance outside the tuner’s specification, which may result in excess voltage and/or current across the tuner’s components.

MORSE CODE AND BEEPS

If insufficient power is applied for tuning (less than two watts), “QRO” (dah-dah-di-dah di-dah-dit dah-dah-dah) will be sent on CW. Increasing the input power above two watts ends this message.

When input power is too high, the tuner enters a self-protection mode. The tuner will not allow any of its relays to change to prevent damage to your tuner. If too much power is applied when tuning, the tuner will cease the tuning routine and send “QRP” (dah-dah-di-dah di-dah-dit di-dah-dah-dit) on CW. This occurs when the forward power exceeds 75 watts and the SWR is greater than 3.0, or when the forward power exceeds 125 watts regardless of the SWR.

If more than 200 watts is applied to the tuner, the tuner will go into bypass mode and send “QRT” (dah-dah-di-dah di-dah-dit dah) on CW.

If the tuning process is activated under these conditions, the tuner will not start the tuning. It will send the appropriate code on CW.

The following table shows the various tuner beeps:

Function	Indicates By One Beep			Indicates By Two Beeps		By Pressing
Primary Memory	1			2		[ALT] < 1 second
Memory Bank	Bank A (1 beep)	Bank B (2 beeps)	Bank C (3 beeps)	Bank D (4 beeps)	Off (5 beeps)	[ALT] > 1 second
Bypass Toggle	Bypass Mode (L = 0 and C = 0)			Restore Last L/C Setting		[TUNE] < 0.5 sec.
Tuned SWR	SWR ≤1.5 (1 beep)	SWR ≤2.0 (2 beeps)	SWR ≤2.5 (3 beeps)	SWR ≤3.0 (4 beeps)	SWR >3.0 (“SWR”)	[TUNE] for 0.5 to 2 seconds
<i>StickyTune</i>	On			Off		[TUNE] > 2 seconds
Tuning Mode	Automatic			Semi-Automatic		[TUNE] + [ALT]

Table 8 Tuner Beeps.

TRANSCEIVER FOLDBACK

Modern transceivers with solid-state finals usually have a foldback circuit to protect the final transistors from damage due to high SWR. A foldback circuit detects the SWR during transmit and reduces the output power as the SWR rises above a preset threshold, usually 2:1. The higher the SWR the lower the power is set to prevent damage.

If your transceiver has a foldback circuit, you can simply key down and tune at any power level from 2 to 100 watts. If your transceiver does not have a foldback circuit, you must manually set the power level to 20 watts or less for tuning. At higher power levels, the reflected power occurred during tuning can damage your transceiver or amplifier and causes component arcing which can damage the relays in the tuner.

Check your transceiver owner's manual to see if it has a foldback circuit. When an amplifier is used, the amplifier must be bypassed during tuning.

Note: MFJ recommends that a transceiver-specific interface cable be used between the MFJ-939 and your transceiver to ensure that tuning only occurs at low power.

GROUNDING HINTS

CAUTION

For operator safety, a good outside earth ground or water pipe ground should always be installed and connected to the case of the MFJ-939. Make certain the safety ground also connects to the transmitter and other station accessories. A wing-nut post marked GROUND is provided for ground connections.

To minimize RFI, single wire feedlines (such as used with Windom or longwire antennas) should be kept away from other wiring. Radiation will be minimized if the single wire feeder runs parallel and reasonably close to the wire that connects the tuner to the outdoor ground. The antenna feed wire should be adequately insulated to prevent arcing or accidental contact.

For safety, always use good DC and RF grounds. It is particularly important to have a good RF ground when using a single wire feeder since the tuner needs something to "push" against in order to force current into the single wire feedline. If a good RF ground is not available, RF will usually find its way back into the power line (RFI), transmitter audio circuits (RF feedback), or the operator (RF burns).

Metal water pipes and ground rods provide good DC and AC safety grounds, but they are almost useless for dependable RF grounding.

RF grounds work much better when "spread out" over a large area, especially when they employ multiple connections directly to the equipment ground point. Metal water pipes, heating ducts, and fences may work (especially if they are connected together with multiple wires), but the best RF grounds are radial systems or multi-wire counterpoises. Radials and counterpoises provide large, low resistance surfaces for RF energy.

RF and lightning travel on the surface of conductors. Braided or woven conductors have high surface resistance to lightning and RF. Ground leads for RF and lightning should have wide smooth surfaces. Avoid the use of woven or braided conductors in RF and lightning grounds unless the lead needs to be flexible.

ANTENNA SYSTEM HINTS

Location

For the best performance, an end-fed longwire wire antenna should be at least one quarter-wavelength long at the operating frequency. Horizontal dipole antennas should be at least a half-wavelength long and located as high and clear as possible. While good RF grounds help the signal in almost any transmitting installation, it is extremely important to have good RF grounds with long wire or other Marconi-style antennas.

Matching Problems

Most matching problems occur when the antenna system presents an extremely high impedance to the tuner. When the antenna impedance is much lower than the feedline impedance, an *odd quarter-wavelength* feedline converts the low antenna impedance to a very high impedance at the tuner. A similar problem occurs if the antenna has an extremely high impedance and the transmission line is a multiple of a half-wavelength. The half-wavelength line *repeats* the very high antenna impedance at the tuner. Incorrect feedline and antenna lengths can make an otherwise perfect antenna system very difficult or impossible to tune.

One example where this problem occurs is on 80 meters when an odd quarter-wave (60 to 70 feet) open wire line is used to feed a half-wave (100 to 140 feet) dipole. The odd quarter-wave line transforms the dipole's low impedance to over three thousand ohms at the tuner. This is because the mismatched feedline is an *odd multiple* of 1/4 wavelength long. The line *inverts* (or teeter-totters) the antenna impedance.

A problem also occurs on 40 meters with this same antenna example. The feedline is now a multiple of a half-wave (60 to 70 feet) and connects to a full-wave high impedance antenna (100 to 140 feet). The half-wave line repeats the high antenna impedance at the tuner. The antenna system looks like several thousand ohms at the tuner on 40 meters.

This places enormous strain on the balun and the insulation in the tuner, since voltages can reach several thousand volts. This can cause component arcing and heating.

The following suggestions will reduce the difficulty in matching an antenna with a tuner:

- Never center feed a half-wave multi-band antenna with a high impedance feedline that is close to an odd multiple of a quarter-wave long.
- Never center feed a full-wave antenna with a feedline close to a multiple of a half-wave long.
- If this tuner will not "tune" a multi-band antenna, add or subtract 1/8 wave of feedline (for the band that won't tune) and try again.
- Never try to load a G5RV or center fed dipole on a band below the half-wave design frequency. If you want to operate an 80-meter antenna on 160 meters, feed either or both conductors as a longwire against the station ground.

To avoid problems matching or feeding any dipole antenna with high impedance open wire lines, keep the lines around these lengths. [The *worst possible* line lengths are shown in brackets]:

160 meters dipole:	35-60, 170-195 or 210-235 feet	[Avoid 130, 260 ft]
80 meters dipole:	34-40, 90-102 or 160-172 feet	[Avoid 66, 135, 190 ft]
40 meters dipole:	42-52, 73-83, 112-123 or 145-155 feet	[Avoid 32, 64, 96, 128 ft]

Some slight trimming or adding of feedline may be necessary to accommodate the higher bands.

WARNING

To avoid problems, a dipole antenna should be a full half-wave on the lowest band. On 160 meters, an 80 or 40 meters antenna fed the normal way will be extremely reactive, with only a few ohms of feedpoint resistance. Trying to load an 80 meters half-wave dipole (or shorter) antenna on 160 meters can be a disaster for both your signal and the tuner. The best way to operate 160 meters with an 80 or 40 meters antenna is to load either or both feedline wires (in parallel) as a longwire. The antenna will act like a "T" antenna worked against station ground.

APPENDICES

POWER-ON OPERATIONS
(Press and hold buttons while turning on the power.)

Press and hold **TUNE** + **POWER** to start the self test.

Press and hold **TUNE** + **ALT** + **POWER** to delete current antenna memory.

Press and hold **ALT** + **POWER** then press **TUNE** 1 time to reset factory defaults.

Press and hold **ALT** + **POWER** then press **TUNE** 2 times to delete current memory bank.

Press and hold **ALT** + **POWER** then press **TUNE** 3 times to perform total reset.

Press and hold **ALT** + **POWER** then press **TUNE** 4 times to test the power-down circuitry.

Press and hold **ALT** + **POWER** then press **TUNE** 5 times to test the relays.

Press and hold **ALT** + **POWER** then press **TUNE** 6 times to calibrate the frequency counter.

Press and hold **ALT** + **POWER** then press **TUNE** 7 times to calibrate the SWR bridge.

For the **ALT** + **POWER** operations, not pressing **TUNE** or pressing it more than seven times will cancel the operation after idling four seconds, beep two times and then resume normal operation.

Figure 13 Power-On Operations.

Resetting the Tuner

Each time the tuner is powered off, the microprocessor saves all memories and configurations to non-volatile memory ready to be used the next time the unit is turned on and transmit power is applied. If the tuner is not working properly, even on initial power on, try resetting to the factory defaults.

Factory Defaults

The unit is shipped with the following default settings:

- Inductance 0 μ H
- Capacitance 0 pF on antenna side
- Antenna 1
- Memory Banks 1A and 2A on †
- Tuning Mode Automatic †

† These settings are stored separately for primary memories 1 and 2.

Note: *Resetting to factory defaults does not erase the antenna memories.*

To reset the tuner to these defaults:

1. Turn off the power to the tuner.
2. Press and hold *only* the [ALT] button while turning the power on. Both LEDs will blink until the button is released.
3. Within four seconds of releasing [ALT], press the [TUNE] button once.
4. After releasing [TUNE] for four seconds, beep three times and resume normal operation.

WARNING: **If the MFJ-939 is not behaving properly or is acting erratically, try resetting the tuner to factory defaults.**

Delete Entire Antenna Memory

To delete an entire antenna memory (all four banks), first select the primary memory (1 or 2) that you want to delete. See “ALT Button” on page 5 for details.

1. Turn off the power to the tuner.
2. Press and hold *both* the [TUNE] and [ALT] buttons while turning the power on. It takes approximately three seconds to delete all four memory banks of the current antenna.
3. Beep three times and release the buttons to resume normal operation. Remember that the selected antenna memory will be lost!

Delete Antenna Memory Bank

To delete an antenna memory bank, first select the primary memory (1 or 2) and the memory bank (A, B, C or D) that you want to delete. See “ALT Button” on page 5 for details.

1. Turn off the power to the tuner.
2. Press and hold *only* the [ALT] button while turning the power on. Both LEDs will blink until the button is released.
3. Within four seconds of releasing [ALT], press the [TUNE] button two times.
4. After releasing [TUNE] for four seconds, the current memory bank is deleted.
5. The unit will beep three times and resume normal operation. Remember that the selected antenna memory bank will be lost! However, if the memory is off, no memory bank is deleted; then beep two times and resume normal operation.
6. Repeat the above procedure to delete the other memory banks, if desired.

Total Reset

To erase *both* primary memories (all eight banks) and reset to factory defaults:

1. Turn off the power to the tuner.
2. Press and hold *only* the [ALT] button while turning the power on. Both LEDs will blink until the button is released.
3. Within four seconds of releasing [ALT], press the [TUNE] button three times.
4. After releasing [TUNE] for four seconds, both primary memories are deleted and factory defaults are reset. The total reset takes approximately six seconds.
5. The unit will beep three times and resume normal operation. Remember that both primary memories will be lost!

Self Test

A self-test routine will check the functions of the MFJ-939. This routine checks the LEDs, the front-panel buttons, the internal memory, the audio circuitry, and the power-down circuitry. During the self-test, you may stop the test by turning off the unit; however, this should NOT be done during the memory test or the memory could be corrupted. The self-test can be completed in approximately 10 seconds.

Note: *Performing the self-test will reset the unit to its factory default settings.*

Here is the self-test procedure:

1. Turn off the power to the tuner.
2. Unplug the radio interface cable, if one is connected, from the tuner.
3. Press and hold *only* the [TUNE] button while turning the power on.
4. The test begins by blinking the firmware version number via the two front panel LEDs. The green LED blinks first, followed by the red LED. The version number X.Y is represented by the

number of times the green LED blinks for X and the number of times the red LED blinks for Y. For example, green LED blinks one time and red LED blinks two times represent firmware version number 1.2. This is also the test of the LEDs.

5. Release the [TUNE] button. The unit then checks for short circuits, power-down detection level, and wakeup circuitry.
6. Press [ALT] button and the green LED should blink once.
7. Press [TUNE] button and the green LED should blink once.
8. The unit then tests its non-volatile memory. Notice this step will reset the unit to its factory default settings.
9. If the unit is okay, a repetitive message "PASS" will be sent as Morse code (di-dah-dah-dit di-dah di-di-dit di-di-dit) and the green LED will blink. If there is a problem, a failure message will be sent repetitively and the red LED will blink.
10. Once you have confirmed that the audio is okay, turn the unit off.
11. Wait one second and turn the unit on again to test the power-down detection circuitry.
12. If the power-down detection circuitry is okay, a repetitive message "PASS" will be sent as Morse code (di-dah-dah-dit di-dah di-di-dit di-di-dit) and the green LED will blink. If there is a problem, message "PD FAIL" will be sent as Morse code repetitively and the red LED will blink.
13. Turn the power off.

Failure Message	Indicates
ANT FAIL	[ALT] button is shorted or improperly connected.
TUNE FAIL	[TUNE] button is shorted or improperly connected.
MEMORY FAIL	Non-volatile memory circuitry is improperly connected.
WAKEUP FAIL	Microprocessor wakeup circuitry problem.
PD FAIL	Power-down circuitry problem.

Table 9 Failure Messages.

Power-Down Circuit Test

When the 12 VDC power to the tuner is turned off, the tuner saves all settings to non-volatile memory. The Power-Down Circuit Test checks the power-down detection circuitry. It is recommended that this test be done immediately after the regular self-test described above.

Note: *The tuner must be reset to factory defaults before performing this test.*

Here is the test procedure:

1. Make sure power to the tuner is off.
2. If the tuner has been reset to factory defaults, skip to step 6; otherwise continue with step 3.
3. Press and hold *only* the [ALT] button while turning the power on. Both LEDs will blink until the button is released.
4. Within four seconds of releasing [ALT], press the [TUNE] button once.
5. After releasing [TUNE] for four seconds, beep three times and turn the power off.
6. Press and hold *only* the [ALT] button while turning the power on. Both LEDs will blink until the button is released.
7. Within four seconds of releasing [ALT], press the [TUNE] button four times.
8. After releasing [TUNE] for four seconds and if the power-down detection circuitry is okay, a repetitive message "PASS" will be sent as Morse code (di-dah-dah-dit di-dah di-di-dit di-di-dit)

and the green LED will blink. If there is a problem, message “PD FAIL” will be sent as Morse code repetitively and the red LED will blink.

9. Turn the power off.

Relay Test

WARNING: Turn off the transmitter power or disconnect the transmitter before performing this test; otherwise, damage to the tuner can result.

To test the relays and their control circuitry;

1. Turn off the power to the tuner.
2. Press and hold *only* the [ALT] button while turning the power on. Both LEDs will blink until the button is released.
3. Within four seconds of releasing [ALT], press the [TUNE] button five times.
4. After releasing [TUNE] for four seconds, beep once and the Relay Test routine is initiated.
5. Press the [TUNE] button to engage the relay and the red LED will turn on. Release the [TUNE] button to disengage the relay and the red LED will turn off. Listen for relay clicks.
6. There are 18 relays in the tuner, yet there are 19 test positions. The second relay tested (K2) is not used in this unit. There will be no relay click for K2. Press the [ALT] button to test the next relay. The green LED will illuminate until the [ALT] button is released.
7. Repeat Steps 5 and 6 to test all 18 relays (in the order of relay K1 to K19, K2 is not used in this unit).
8. After releasing [ALT] on the 19th test position, the unit will beep three times and resume normal operation.

Frequency Counter Calibration

To calibrate the frequency counter, you will need a transmitter, a 50-ohm dummy load, two 50-ohm SO-239 coax cables, a Phillips screwdriver, and a tuning tool or small flat blade screwdriver.

WARNING: Do not touch anything inside the tuner during operation! Serious, painful RF burns can result.

WARNING: Never operate the MFJ-939 with its cover removed; dangerous voltages and currents can be present during operation. Never exceed tuner specifications.

1. Turn off the power to the transmitter and the tuner.
2. Remove the cover from the tuner (10 screws) with a Phillips screwdriver.
3. Connect the 50-ohm dummy load to the ANTENNA connector; connect the transmitter to the TRANSMITTER connector on the tuner.
4. Turn on the power to the transmitter. Set and lock the frequency to *exactly* 29.000 MHz.
5. Press and hold *only* the [ALT] button while turning the power on. Both LEDs will blink until the button is released.
6. Within four seconds of releasing [ALT], press the [TUNE] button six times.
7. After releasing [TUNE] for four seconds, the green LED lights up and the Frequency Counter Calibration is initiated.
8. Key the transmitter to output about 10 watts and adjust trimmer capacitor VC3 (located next to the big integrated circuit on the front side of the front panel circuit board) until both LEDs are

lighted up. The green LED lights when the calibration is below 29 MHz, the red LED lights when the calibration is above 29 MHz and both LEDs light up when the calibration equals to 29 MHz.

9. Unkey the transmitter. Turn off the power to the transmitter and the tuner.
10. Secure the cover back onto the tuner.

SWR Bridge Calibration

To calibrate the SWR Bridge, you will need a transmitter capable of 100 watts output, a precise calibrated wattmeter, a 50-ohm dummy load, three 50-ohm SO-239 coax cables, a Phillips screwdriver, a tuning tool or small flat blade screwdriver, and a cross-needle wattmeter (available only at MFJ factory). Therefore, this calibration can only be done at MFJ factory.

WARNING: Do not touch anything inside the tuner during operation! Serious, painful RF burns can result.

WARNING: Never operate the MFJ-939 with its cover removed; dangerous voltages and currents can be present during operation. Never exceed tuner specifications.

1. Turn off the power to the transmitter and the tuner.
2. Remove the cover from the tuner (10 screws) with a Phillips screwdriver.
3. Connect the cross-needle wattmeter to header HD1, located behind the front panel circuit board.
4. Connect the 50-ohm dummy load to the ANTENNA connector; connect the wattmeter between the transmitter and the TRANSMITTER connector on the tuner.
5. Turn on the power to the transmitter. Using a frequency in the middle of the HF band, such as 7.253 MHz, for calibration is recommended.
6. Press and hold *only* the [ALT] button while turning the power on. Both LEDs will blink until the button is released.
7. Within four seconds of releasing [ALT], press the [TUNE] button seven times.
8. After releasing [TUNE] for four seconds, the cross-needle wattmeter shows 100 watts forward and 20 watts reflected and the SWR Bridge Calibration is initiated.
9. Make sure the cross-needle wattmeter reads 100 watts forward and 20 watts reflected. If not, calibrate the cross-needle wattmeter.
10. Press the [TUNE] button and both meter needles drop to 0 watt marks.
11. Key the transmitter to output 100 watts and adjust trimmer capacitor VC1 (located in front of the TRANSMITTER connector) for minimum reflected power. Notice the reflected meter movement is exaggerated for easier calibration.
12. Key the transmitter to output 100 watts and adjust the FWD trimpot VR1 (located next to the RADIO INTERFACE connector) until the forward meter shows 100 watts.
13. Press the [TUNE] button and the reflected meter goes to full scale.
14. Turn off the transmitter and reverse the ANTENNA and TRANSMITTER connections; that is, connect the 50-ohm dummy load to the TRANSMITTER connector and connect the transmitter/wattmeter to the ANTENNA connector.
15. Turn on the transmitter's power.
16. Key the transmitter to output 100 watts and adjust the REF trimpot VR2 (located next to the RADIO INTERFACE connector) until the forward meter (yes, the forward meter) shows 100 watts; the reflected meter is at full scale.
17. Press the [TUNE] button to end calibration.
18. Turn off the power to the transmitter and the tuner.

19. Remove the cross-needle wattmeter from header HD1.
20. Remove the transmitter/wattmeter and the 50-ohm dummy load from the tuner.
21. Secure the cover back onto the tuner.
22. Connect your transmitter to the TRANSMITTER connector and connect your antenna to the ANTENNA connector on the tuner.

Jumper Settings

There are several sets of jumpers that can be used to configure the MFJ-939 to match specific radios and functions. Jumpers not listed in this chart are reserved for future use.

0 is no jumper, 1 or a letter is a jumper installed, and X indicated a do not care setting.

Jumper JP1 is used to disconnect power from the interface cable to insure the radio does not power the tuner if the radio can not supply the needed power.

Jumper JP1	Function
0	Disconnects power from the interface cable
1	Connects power from the interface cable

Table 10 Jumper JP1 Setting

Jumper JP2 is used to set the MFJ-939 to the radio model in use. Note that no jumper disables the radio interface.

Jumper JP2	To Interface	Using Cable
0	No Radio Interface	--
I	Alinco Icom Yaesu FT-1000MP FT-2000 FT-9000 Yaesu FT-2000	MFJ-5114A MFJ-5114I MFJ-5114Y3 MFJ-5114Y3 MFJ-5114Y4
K	Kenwood	MFJ-5114K
Y	Yaesu FT-100 FT-450 FT-857 FT-897 FT-950	MFJ-5114Y
1	Reserved	--
2	Reserved	--
3	Reserved	--
4	Reserved	--

Table 11 Jumper JP2 Setting

Jumper JP4 is used to set a pull up resistor on tuner data lines when needed.

Jumper JP4	Function
0	Icom, IC-706, IC-707, IC-718, IC-725, IC-728, IC-736, IC-738, IC-746, IC-756, IC-7000
1	Kenwood TS-50S, TS-450S, TS-480HX, TS-570S, TS-590, TS-690S, TS-850S, TS-870S, TS-2000 Yaesu FT-100, FT-450, FT-847, FT-857, FT-897, FT-950
X	Yaesu FT-1000MP FT-2000 FT-9000 Alinco DX-70, DX-77, DX-701, DX-801

Table 12 Jumper JP4 Setting

IN CASE OF DIFFICULTY

If the tuner acts erratic, reset the tuner to factory defaults.

If the tuner fails to tune, please **double check** all connections and follow the tuning procedures again. Be sure you are using *enough inductance* (through manual adjustment) and *minimum capacitance*.

If the tuner arcs at the rated power levels, please **double check** all connections and follow the tuning procedures again. Ensure you are not exceeding the tuner's rated power handling capability. Be sure you are using the *least amount of inductance* and the *greatest capacitance* possible that still allows matching the load on the operating frequency.

Note: *If the tuner arcs when operating on the 160-meter band, it may be necessary to reduce transmitter output power.*

If you are still unsuccessful, but the tuner does adjust and operate when used with a dummy load or another antenna, please read “Grounding Hints” and “Antenna System Hints” on page 13.

TECHNICAL ASSISTANCE

If you have any problem with this unit first check the appropriate section of this manual. If the manual does not reference your problem or your problem is not solved by reading the manual, you may call *MFJ Technical Service* at 662-323-0549 or the *MFJ Factory* at 662-323-5869. You will be best helped if you have your unit, manual and all information on your station handy so you can answer any questions the technicians may ask.

You can also send questions by mail to MFJ Enterprises, Inc., 300 Industrial Park Road, Starkville, MS 39759; by facsimile (FAX) to 662-323-6551; or by email to techinfo@mfjenterprises.com. Send a complete description of your problem, an explanation of exactly how you are using your unit, and a complete description of your station. Also include the firmware version number of your unit.

LIST OF ACCESSORIES

- **MFJ-1316:** 12 VDC 1.5 amp power supply
- **MFJ-5114A:** Interface cable for compatible Alinco radios
- **MFJ-5114I:** Interface cable for compatible Icom radios
- **MFJ-5114K:** Interface cable for compatible Kenwood radios
- **MFJ-5114Y:** Interface cable for Yaesu FT-100, FT-450, FT-857, FT-897, and FT-950
- **MFJ-5114Y3:** Interface cable for Yaesu FT-1000MP series, FT-2000 series, and FTDX-9000 series
- **MFJ-5114Y4:** Interface cable for Yaesu FT-2000 series (use TX REQ input instead of REM input)
- **MFJ-5803:** 3' RG-58 50-ohm coax cable with PL-259 connectors on each end (tuner input only)
- **MFJ-5806:** 6' RG-58 50-ohm coax cable with PL-259 connectors on each end (tuner input only)
- **MFJ-5818:** 18' RG-58 50-ohm coax cable with PL-259 connectors on each end (tuner input only)

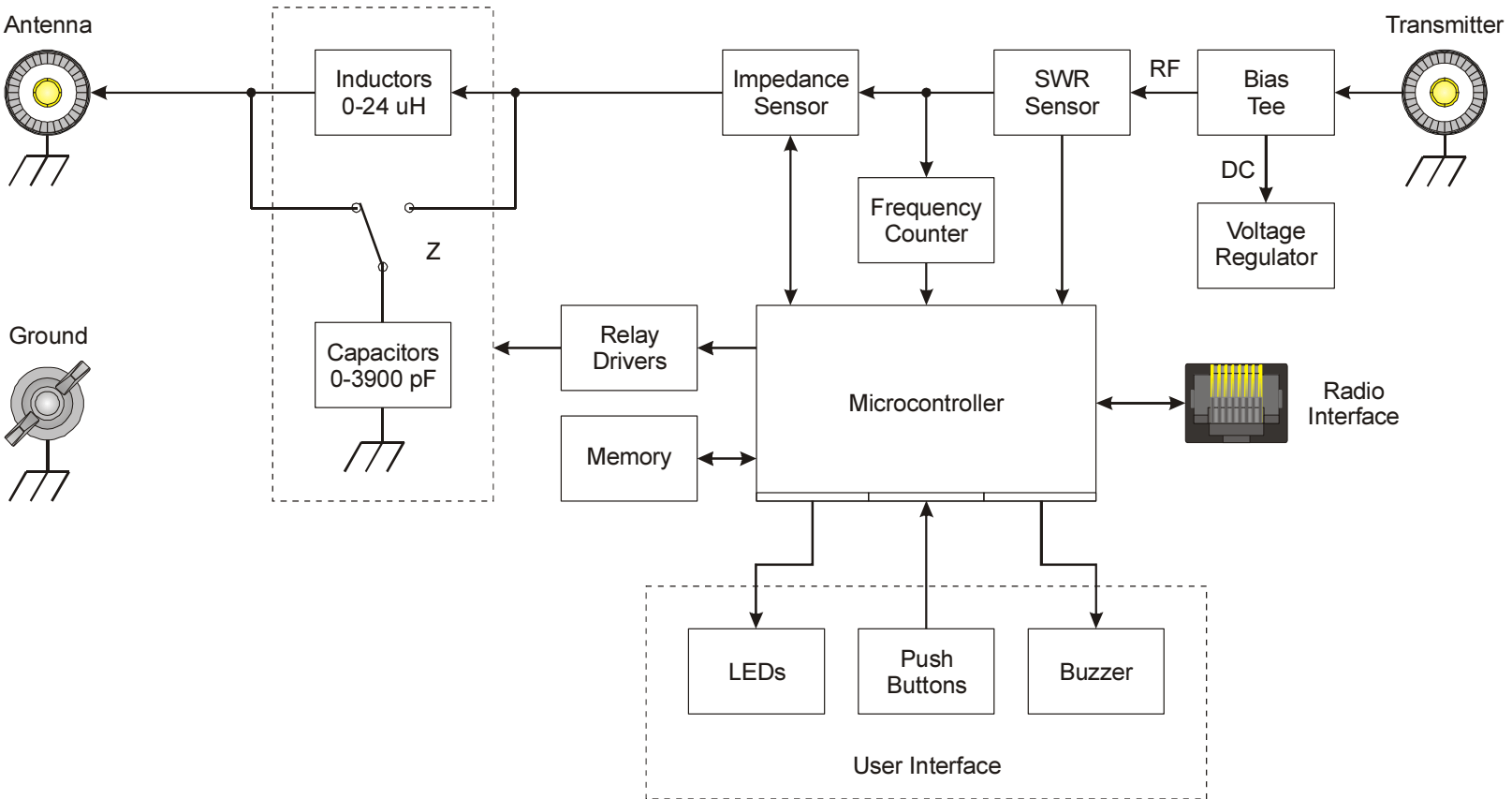

Figure 14 Block Diagram

FULL 24-MONTH WARRANTY

MFJ Enterprises, Inc. warrants to the original owner of the MFJ-939 by MFJ Enterprises, Inc. and purchased from an authorized dealer or directly from MFJ Enterprises, Inc. to be free from defects in material and workmanship for a period of 24 months from date of purchase provided the following terms of this warranty are satisfied.

1. The purchaser must retain the dated proof-of-purchase (bill of sale, canceled check, credit card or money order receipt, etc.) describing the product to establish the validity of the warranty claim and submit the original or machine reproduction of such proof of purchase to MFJ Enterprises, Inc. at the time of warranty service. MFJ Enterprises, Inc. shall have the discretion to deny warranty without dated proof-of-purchase. Any evidence of alteration, erasure, or forgery shall be cause to void any and all warranty terms immediately.
2. MFJ Enterprises, Inc. agrees to repair or replace at MFJ's option without charge to the original owner any defective product provided the product is returned postage prepaid to MFJ Enterprises, Inc. with a personal check, cashiers check, or money order for **\$12.00** covering postage and handling.
3. MFJ Enterprises, Inc. will supply replacement parts free of charge for any MFJ product under warranty upon request. A dated proof of purchase and a **\$8.00** personal check, cashiers check, or money order must be provided to cover postage and handling.
4. This warranty is **NOT** void for owners who attempt to repair defective units. Technical consultation is available by calling (662) 323-5869.
5. This warranty does not apply to kits sold by or manufactured by MFJ Enterprises, Inc.
6. Wired and tested PC board products are covered by this warranty provided **only the wired and tested PC board product is returned**. Wired and tested PC boards installed in the owner's cabinet or connected to switches, jacks, or cables, etc. sent to MFJ Enterprises, Inc. will be returned at the owner's expense un-repaired.
7. Under no circumstances is MFJ Enterprises, Inc. liable for consequential damages to person or property by the use of any MFJ products.
8. **Out-of-Warranty Service:** MFJ Enterprises, Inc. will repair any out-of-warranty product provided the unit is shipped prepaid. All repaired units will be shipped COD to the owner. Repair charges will be added to the COD fee unless other arrangements are made.
9. This warranty is given in lieu of any other warranty expressed or implied.
10. MFJ Enterprises, Inc. reserves the right to make changes or improvements in design or manufacture without incurring any obligation to install such changes upon any of the products previously manufactured.
11. All MFJ products to be serviced in-warranty or out-of-warranty should be addressed to **MFJ Enterprises, Inc., 300 Industrial Park Rd, Starkville, Mississippi 39759, USA** and must be accompanied by a letter describing the problem in detail along with a copy of your dated proof-of-purchase and a telephone number.
12. This warranty gives you specific rights, and you may also have other rights, which vary from state to state.



MFJ ENTERPRISES, INC.
300 Industrial Park Road
Starkville, MS 39759

MFJ-939 Manual
Version 0A
Printed In U.S.A