

COMMUNICATIONS RECEIVER
IC-R9500

Instruction Manual

FOREWORD

Thank you for making the IC-R9500 your radio of choice. We hope you agree with Icom's philosophy of "technology first." Many hours of research and development went into the design of your IC-R9500.

◇ **FEATURES**

- *Ultimate receiver performance: 109 dB wide dynamic range and third-order intercept (IP3) of +40 dBm (HF bands only)*
- *7-inch wide color TFT LCD*
- *Built-in Baudot FSK demodulator*
- *High resolution spectrum scope— center frequency and fix frequency modes, plus mini-scope displays*

IMPORTANT

READ THIS INSTRUCTION MANUAL CAREFULLY before attempting to operate the receiver.

SAVE THIS INSTRUCTION MANUAL. This manual contains important safety and operating instructions for the IC-R9500.

EXPLICIT DEFINITIONS

WORD	DEFINITION
⚠ WARNING	Personal injury, fire hazard or electric shock may occur.
CAUTION	Equipment damage may occur.
NOTE	If disregarded, inconvenience only. No risk of personal injury, fire or electric shock.

TRADEMARKS

Icom, Icom Inc. and the  logo are registered trademarks of Icom Incorporated (Japan) in the United States, the United Kingdom, Germany, France, Spain, Russia and/or other countries.

ABOUT RE-EXPORTING THIS PRODUCT:

If re-exporting this product, it is your responsibility to check you are in compliance with the export regulations of your country or the country you are exporting to. Export regulations can be highly restrictive in relation to some of the technology implemented in this product. Your failure to comply with export regulations may subject you to fines or penalties. Please consult with the relevant Government Department in your country.

PRECAUTIONS

⚠ **WARNING! NEVER** operate the receiver with a headset or other audio accessories at high volume levels. Hearing experts advise against continuous high volume operation. If you experience a ringing in your ears, reduce the volume or discontinue use.

⚠ **CAUTION! NEVER** change the internal settings of the receiver. This may reduce receiver performance and/or damage to the receiver.

The receiver warranty does not cover any problems caused by unauthorized internal adjustment.

⚠ **CAUTION!** The receiver weighs approx. 20 kg (44 lb). Always have two people available to carry, lift or turn over the receiver.

⚠ **CAUTION!** The line-voltage receptacle must be near the receiver and must be easily accessible. Avoid extension cords.

⚠ **ACHTUNG!** Die Steckdose muß nahe bei diesem Gerät angebracht und zugänglich sein.

⚠ **NEVER** let metal, wire or other objects protrude into the receiver or into connectors on the rear panel. This may result in an electric shock.

⚠ **NEVER** block any cooling vents on the top, rear or bottom of the receiver.

⚠ **NEVER** expose the receiver to rain, snow or any liquids.

⚠ **NEVER** install the receiver in a place without adequate ventilation. Heat dissipation may be reduced, and the receiver may be damaged.

⚠ **NEVER** operate or touch the receiver with wet hands. This may result in an electric shock or damage to the receiver.

DO NOT use chemical agents such as benzine or alcohol when cleaning the IC-R9500, as they can damage the receiver's surfaces.

AVOID using or storing the receiver in areas with temperatures below $\pm 0^{\circ}\text{C}$ ($+32^{\circ}\text{F}$) or above $+50^{\circ}\text{C}$ ($+122^{\circ}\text{F}$).

AVOID placing the receiver in excessively dusty environments or in direct sunlight.

AVOID placing the receiver against walls or putting anything on top of the receiver. This may overheat the receiver.

Always place unit in a secure place to avoid inadvertent use by children.

The LCD display may have cosmetic imperfections that appear as small dark or light spots. This is not a malfunction or defect, but a normal characteristic of LCD displays.

During maritime mobile operation, keep the receiver as far away as possible from the magnetic navigation compass to prevent erroneous indications.

Turn [I/O] switch (on the rear panel) OFF and/or disconnect the AC power cable from the AC outlet when you will not use the receiver for a long period of time.

For U.S.A. only

CAUTION: Changes or modifications to this device, not expressly approved by Icom Inc., could void your authority to operate this device under FCC regulations.

ABOUT APCO PROJECT 25

This device made under license under one or more of the following US patents: #4,590,473, #4,636,791, #5,148,482, #5,185,796, #5,271,017, #5,377,229.

The IMBE™ voice coding technology embodied in this product is protected by intellectual property rights including patent rights, copyrights and trade secrets of Digital Voice Systems, Inc. This voice coding Technology is licensed solely for use within this communications equipment. The user of this technology is explicitly prohibited from attempting to decompile, reverse engineer, or disassemble the object code, or in any other way convert the object code into a human-readable form. U.S. Pat. nos. #5,870,405, #5,826,222, #5,754,974, #5,701,390, #5,715,365, #5,649,050, #5,630,011, #5,581,656, #5,517,511, #5,491,772, #5,247,579, #5,226,084, #5,195,166.

P25 digital mode is available when the optional UT-122 DIGITAL UNIT is installed.

SUPPLIED ACCESSORIES

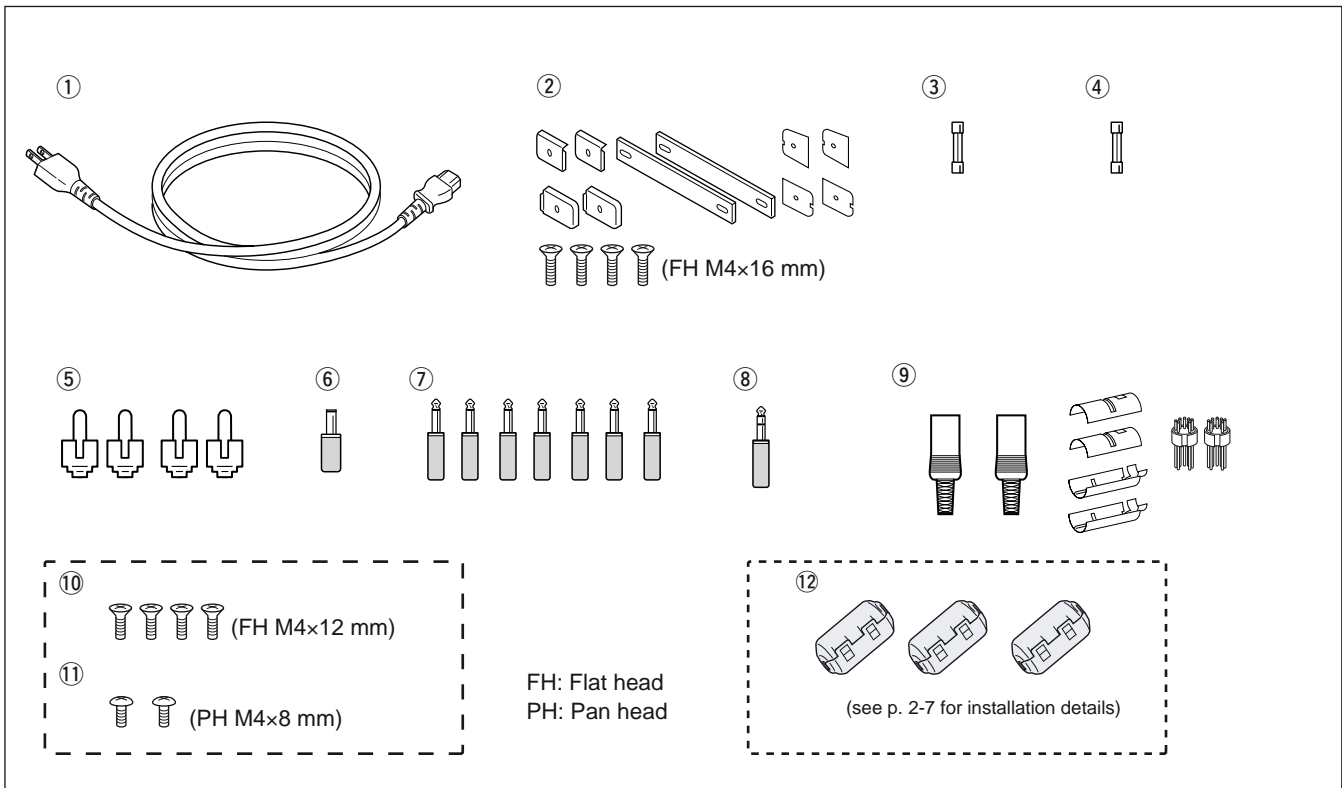

- ① AC power cable* 1
- ② Carrying handles 1 set
- ③ Spare fuse (FGB 1 A) 1
- ④ Spare fuse
FGB 4 A (100 V/120 V versions) 1
0234002MXP (230 V/240 V versions) 1
- ⑤ RCA plugs 4
- ⑥ DC power plug 1
- ⑦ 2-conductor 1/8" plugs 7
- ⑧ 3-conductor 1/8" plugs 1
- ⑨ 8 pin ACC plugs 2
- ⑩ Screws for side plate† 4
- ⑪ Hiding screws for screw hole† 2
- ⑫ Ferrite bead† 3

*May differ from that shown according to version.

†These screw are used when removing rack mounting handles.

‡These are used when connecting cables to [DATA IN], [LAN] or [USB].

TABLE OF CONTENTS

Section 1	PANEL DESCRIPTION	
	■ Front panel	1-2
	■ Rear panel	1-10
	■ LCD display	1-12
	■ Screen menu arrangement	1-14
Section 2	INSTALLATION AND CONNECTIONS	
	■ Unpacking	2-2
	■ Selecting a location	2-2
	■ Grounding	2-2
	■ Antenna connection	2-3
	■ TV jumper cable connection (except for USA versions)	2-4
	■ Carrying handle attachment	2-4
	■ Rack mounting handle detachment	2-4
	■ Required connections	2-5
	◇ Rear panel	2-5
	■ Advanced connections	2-6
	◇ Front panel	2-6
	◇ Rear panel—1	2-6
	◇ Rear panel—2	2-7
	■ Tape recorder connections	2-8
	◇ Recording from the front panel or rear panel	2-8
	◇ Separately recording audio and frequency	2-9
	■ Monitor display connection	2-10
	■ Transceive function	2-10
	■ FSK and AFSK (SSTV) connections	2-11
	■ Accessory connector information	2-12
Section 3	BASIC OPERATIONS	
	■ When first applying power (CPU resetting)	3-2
	■ Initial settings	3-2
	■ Selecting VFO mode	3-3
	■ Selecting memory mode	3-3
	■ Frequency setting	3-4
	◇ Direct frequency entry with the keypad	3-4
	◇ Tuning with the main dial	3-5
	◇ Selecting a tuning step	3-5
	◇ Auto tuning step function	3-6
	◇ 1/4 tuning step function	3-6
	■ Operating mode selection	3-7
	■ Volume setting	3-8
	■ RF gain adjustment	3-8
	■ Squelch level adjustment	3-8
	■ Audio tone adjustment	3-9
	◇ Treble level adjustment	3-9
	◇ Bass level adjustment	3-9
	■ Meter indication selection	3-10
	◇ Meter type selection	3-10
Section 4	RECEIVE MODES	
	■ Operating FM	4-2
	◇ Convenient functions for FM	4-2
	■ Duplex operation	4-3
	◇ Offset frequency setting	4-3

TABLE OF CONTENTS

■ Tone/DTCS squelch operation	4-4
■ Operating WFM	4-5
◇ Convenient functions for WFM	4-5
■ Operating AM	4-6
◇ Convenient functions for AM	4-6
■ Operating SSB	4-7
◇ Convenient functions for SSB	4-7
■ Operating CW	4-8
◇ Convenient functions for CW	4-8
◇ APF (Audio Peak Filter) operation	4-9
◇ About CW reverse mode	4-9
◇ About CW pitch control	4-9
■ Operating FSK	4-10
◇ Convenient functions for FSK	4-11
◇ About FSK reverse mode	4-11
◇ Twin peak filter	4-11
◇ Setting FSK tone frequency	4-12
◇ Functions for the FSK decoder indication	4-13
◇ Setting the decoder threshold level	4-13
◇ FSK decode set mode	4-14
◇ Setting FSK Baud rate	4-16
◇ Time stamp function	4-16
◇ Data saving	4-17
■ Operating P25 (Requires optional UT-122)	4-18
◇ Convenient functions for P25	4-18
■ Digital squelch operation	4-19
■ TV channel operation (except for USA versions).....	4-20
◇ Convenient functions for TV operation	4-20

Section 5 RECEIVE FUNCTIONS

■ Spectrum scope screen	5-2
◇ Center mode	5-2
◇ Fix mode	5-3
◇ Peak marker function	5-4
◇ Wide band-pass filter selection.....	5-5
◇ Wide band scope function	5-5
◇ Mini scope screen indication	5-6
◇ Scope set mode	5-6
■ Preamplifier	5-9
■ Attenuator	5-9
■ AGC function	5-10
◇ Selecting the preset value	5-10
◇ Adjusting the AGC time constant	5-10
◇ Setting the AGC time constant preset value	5-10
■ Twin PBT operation	5-11
■ IF filter selection	5-12
◇ IF filter selection	5-12
◇ Filter passband width setting	5-12
◇ Roofing filter selection	5-13
◇ DSP filter shape	5-13
◇ Filter shape set mode	5-13
■ Noise blanker	5-15
◇ NB set mode	5-15

TABLE OF CONTENTS

	■ Noise reduction	5-16
	■ Notch function	5-16
	■ Autotune function	5-17
	■ AFC function	5-17
Section 6	VOICE RECORDER FUNCTIONS	
	■ About digital voice recorder	6-2
	■ Recording a received audio	6-3
	◇ Regular recording	6-3
	■ Playing the recorded audio	6-4
	◇ Regular playing	6-4
	■ Erasing the recorded contents	6-4
	■ Selecting the CF memory card or USB-Memory	6-4
	■ Short recording	6-5
	◇ Recording	6-5
	◇ Playing back	6-5
	■ Voice set mode	6-6
Section 7	MEMORY OPERATION	
	■ Memory channels	7-2
	■ Memory channel selection	7-3
	◇ Using the [M-CH]/[BANK] selectors	7-3
	◇ Using the keypad	7-3
	■ Memory channel programming	7-4
	◇ Programming in VFO mode	7-4
	◇ Programming in memory mode	7-4
	■ Frequency transferring	7-5
	◇ Transferring in VFO mode	7-5
	◇ Transferring in memory mode	7-5
	■ Memory names	7-6
	◇ Editing (programming) memory names	7-6
	■ Memory clearing	7-6
	■ Memory list screen	7-7
	◇ Selecting a memory channel using the memory list screen	7-7
	◇ Confirming programmed memory channels	7-7
	◇ Memory bank set	7-8
	◇ Editing memory channel	7-9
Section 8	SCANS	
	■ Scan types	8-2
	■ Preparation	8-3
	■ Voice squelch control function	8-3
	■ Scan set mode	8-4
	■ Priority scan	8-5
	◇ Setting	8-5
	◇ Priority scan operation	8-5
	■ Programmed scan	8-6
	◇ Setting	8-6
	◇ Program scan operation	8-7
	■ Δ F scan	8-8
	◇ Setting	8-8
	◇ Δ F scan operation	8-8
	■ Fine programmed scan/fine Δ F scan operation	8-9
	■ Auto memory write scan operation	8-10

TABLE OF CONTENTS

	■ Memory scan	8-11
	◇ Setting	8-11
	◇ Memory scan operation	8-11
	◇ Programming the select memory scan setting	8-12
	◇ Select memory scan operation	8-13
	◇ Mode select memory scan operation	8-14
	■ Skip scan	8-15
	◇ Specifying skip channels	8-15
	◇ Programming skip frequencies (for programming scan)	8-15
	◇ Skip scan setting	8-15
	■ Tone scan	8-16
	■ Scan resume condition	8-17
	■ Scan speed	8-18
	■ Scan delay	8-18
Section 9	OTHER FUNCTIONS	
	■ Voice synthesizer operation	9-2
	■ Lock function	9-2
	◇ Dial lock function	9-2
	◇ Panel lock function	9-2
	■ Dial click function	9-3
	■ Antenna selection	9-3
Section 10	CLOCK AND TIMERS	
	■ Time set mode	10-2
	■ Daily timer setting	10-3
	■ Setting sleep timer	10-4
	■ Timer operation	10-4
Section 11	SET MODE	
	■ Set mode description	11-2
	◇ Set mode operation	11-2
	◇ Screen arrangement	11-3
	■ Level set mode	11-4
	■ ACC set mode	11-7
	■ Display set mode	11-8
	■ Others set mode	11-10
	■ CF card/USB-Memory set menu	11-16
	◇ CF/USB-Memory set screen arrangement	11-16
	◇ Load option set mode	11-17
	■ File saving	11-18
	■ File loading	11-19
	■ Changing the file name	11-20
	■ File copying	11-21
	■ Deleting a file	11-22
	■ Unmount an USB-Memory	11-22
	■ Formatting the CF card or USB-Memory	11-23
	■ Display set (Video) mode	11-24
	■ LCD set mode	11-26
Section 12	MAINTENANCE	
	■ Troubleshooting	12-2
	◇ Receiver power	12-2
	◇ Receiving	12-2

TABLE OF CONTENTS

	◇ Scanning	12-3
	◇ Display	12-3
	◇ Voice recorder	12-3
	◇ Format memory media	12-3
	■ Screen type selection	12-4
	■ Main dial brake adjustment	12-4
	■ Frequency calibration (approximate)	12-5
	■ Opening the receiver's case	12-6
	■ Opening the shield case	12-6
	■ UT-122 installation	12-7
	■ Clock backup battery replacement	12-7
	■ Fuse replacement	12-8
	◇ AC power input fuse	12-8
	◇ DC output fuse	12-8
	■ Resetting the CPU	12-9
	■ Screen Saver Function	12-9
Section 13	CONTROL COMMAND	
	■ Remote interface (CI-V) information	13-2
	◇ CI-V connection example	13-2
	◇ Data format	13-2
	◇ Command table	13-3
	◇ To send/read memory contents	13-10
	◇ Codes for memory name, bank name, opening message, and clock 2 name contents	13-10
	◇ Offset frequency setting	13-10
	◇ Tone squelch frequency setting	13-10
	◇ DTCS squelch code setting	13-10
	◇ NAC squelch code setting	13-11
	◇ Selective squelch code settings	13-11
	◇ Color setting	13-11
	◇ Data mode with filter width setting	13-11
Section 14	SPECIFICATIONS AND OPTIONS	
	■ Specifications	14-2
	◇ General	14-2
	◇ Receiver	14-3
	■ Options	14-4
Section 15	UPDATING THE FIRMWARE	
	■ General	15-2
	■ Caution	15-2
	■ Preparation	15-3
	◇ Firmware and firm utility	15-3
	◇ File downloading	15-3
	■ Firmware update— CF memory card	15-4
	■ Firmware update— PC	15-6
	◇ Connections	15-6
	◇ IP address setting	15-7
	◇ Updating from the PC	15-8

PANEL DESCRIPTION

Section 1

■ Front panel	1-2
■ Rear panel	1-10
■ LCD display	1-12
■ Screen menu arrangement	1-14

■ Front panel

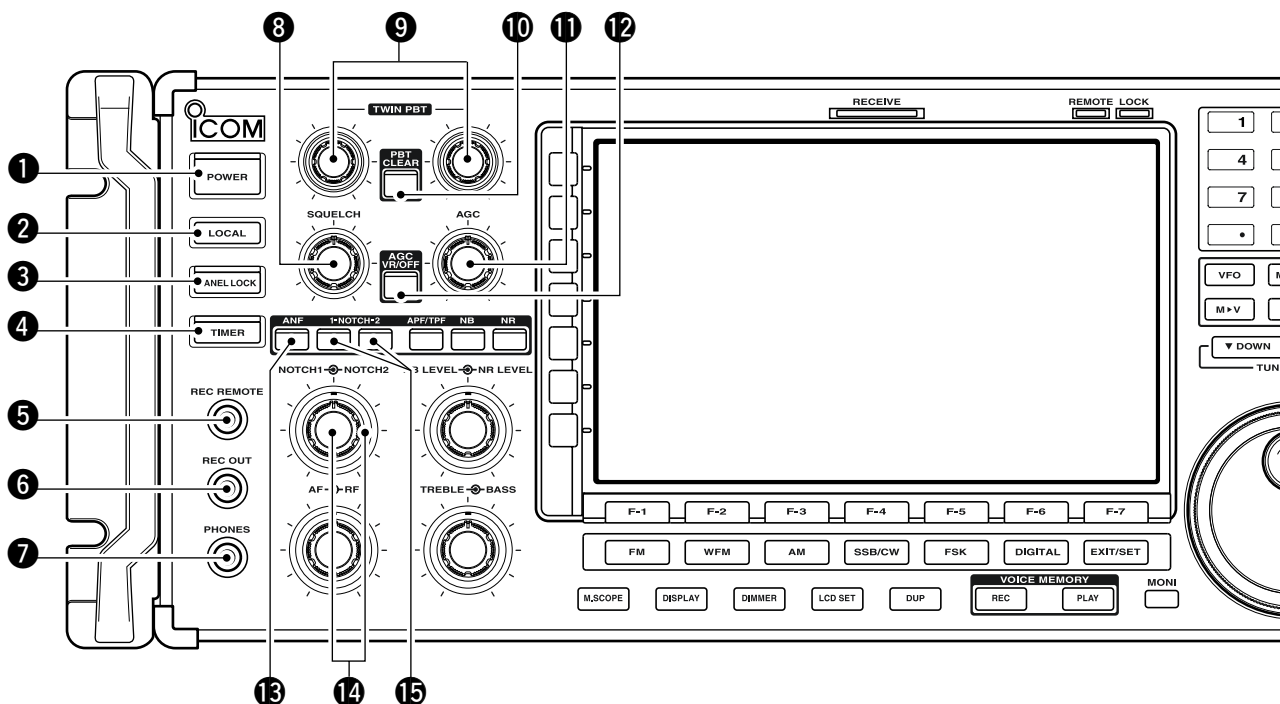

1 POWER SWITCH [POWER] (p. 3-2)

Turn the internal power supply ON before turning the unit ON from the front panel. The internal power supply switch is located on the rear panel. (p. 3-2)

- Push to turn the receiver power ON.
 - The [POWER] indicator above this switch lights green when powered ON.
- Push for 1 sec. to turn the receiver power OFF.
 - The [POWER] indicator lights orange when the receiver is OFF when the internal power supply is switched ON.

2 REMOTE CONTROL SWITCH [LOCAL]

Push to cancel remote control operation from a PC via a CI-V data.

- The [REMOTE] indicator lights orange while in remote control operation.
- When the [REMOTE] indicator lights orange, all dials, keys or switches other than this switch are disabled.

3 PANEL LOCK SWITCH [PANEL LOCK] (p. 9-2)

➤ Push to turn the panel lock function ON or OFF. The panel lock function locks all dials (depends on set mode setting on p. 11-10), keys and switches other than [POWER] and [PANEL LOCK].

- The [PANEL LOCK] indicator above this switch lights green when the panel lock is in use.
- The dial lock function is also available.

➤ Push and hold for 1 sec. to turn the panel lock with display sleep function ON.

- Pushing [PANEL LOCK] turns this function OFF.
- The [PANEL LOCK] indicator above this switch lights green and the display turns OFF when the sleep function is in use.

4 TIMER SWITCH [TIMER] (p. 10-3)

- Turns the sleep or daily timer function ON or OFF.
 - The [TIMER] indicator above this switch lights green when the timer is in use.
- Enters timer set mode when pushed and held for 1 sec.

5 RECORDER REMOTE JACK [REC REMOTE]

Controls the operation of a tape recorder for recording. Connects to the REMOTE jack on a tape recorder.

6 RECORDER JACK [REC OUT]

Outputs an audio signal. Connect to the AUX or LINE IN jack on a tape recorder.

7 HEADPHONE JACK [PHONES]

Accepts standard 3.5 (d) mm (1/8) stereo headphones.

- Output power: 40 mW with an 8 Ω load.
- When headphones are connected, the internal speaker or connected external speaker does not function.

8 SQUELCH CONTROL [SQUELCH] (p. 3-8)

Adjusts the squelch threshold level. The squelch disables output from the speaker (closed condition) when no signal is received.

- The squelch control is particularly effective for FM or AM. It is also available for other modes.
- 11 to 12 o'clock position is recommended for any setting of the [SQL] control.

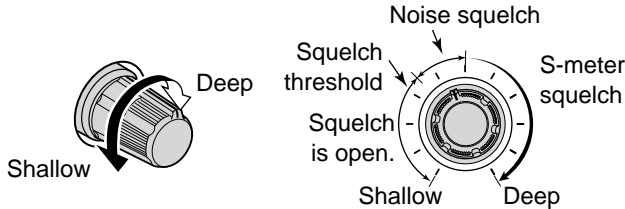

9 PASSBAND TUNING CONTROLS [TWIN PBT] (p. 5-11)

Adjusts the IF filter “passband width” via the DSP.

- Passband width and shift frequency are shown on the multifunction display.
- Push and hold [PBT CLEAR] for 1 sec. to clear the PBT settings.
- Variable range is set to half of the IF filter passband width. 25 Hz steps and 50 Hz steps are available in SSB, CW and FSK modes.

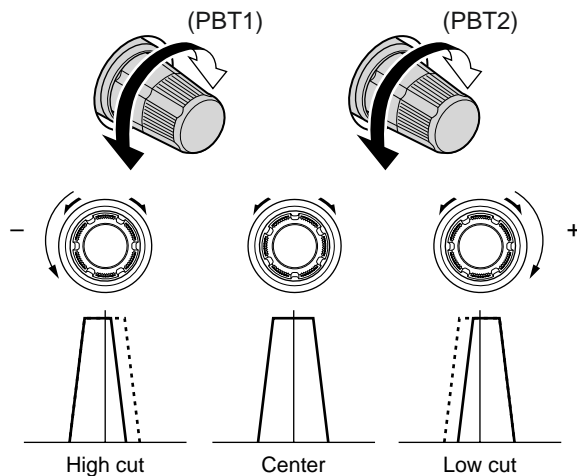

✓ What is the PBT control?

The PBT function electronically modifies the IF passband width to reject interference. This receiver uses the DSP circuit for the PBT function.

10 PBT CLEAR SWITCH [PBT CLEAR] (p. 5-11)

- Push and hold for 1 sec. to clear the PBT settings.
- The [PBT CLEAR] indicator above this switch lights when PBT is in use.

11 AGC CONTROL [AGC] (p. 5-10)

Adjusts the continuously-variable AGC circuit time constant.

- To use [AGC] control, push the appropriate band’s [AGC VR/OFF] ([AGC VR] indicator lights green).



12 AGC SWITCH [AGC VR/OFF] (p. 5-10)

- ➔ Push to toggle [AGC] control usage ON or OFF.
 - Use [AGC] control to set the AGC time constant when switched ON.
 - The [AGC VR] indicator above this switch lights green when the control is ON.
- ➔ Turns the AGC function OFF when pushed and held for 1 sec.

13 AUTO NOTCH SWITCH [ANF] (p. 5-16)

- ➔ Turns the auto notch function ON or OFF when pushed in SSB, AM, FM and WFM mode.
 - “AN” appears when auto notch is in use.

14 MANUAL NOTCH SWITCHES [NOTCH1]/[NOTCH2] (p. 5-16)

- ➔ Turns the manual notch function ON or OFF when pushed in SSB, CW, AM and FSK mode.
 - “MN1” or “MN2” appear when manual notch is in use.
- ➔ Switches the manual notch characteristics between wide, middle and narrow when pushed and held for 1 sec.

✓ What is the notch function?

The notch function eliminates unwanted CW or AM carrier tones while preserving the desired voice signal. The DSP circuit automatically adjusts the notch frequency to effectively eliminate unwanted tones.

15 MANUAL NOTCH FILTER CONTROLS [NOTCH1]/[NOTCH2] (p. 5-16)

Varies the “notch” frequency of the manual notch filter to reject an interfering signal while the manual notch function is ON.

- Notch filter center frequency:
 - SSB : -1060 Hz to 4040 Hz
 - CW : CW pitch freq. + 2540 Hz to CW pitch freq. -2540 Hz
 - AM : -5100 Hz to 5100 Hz

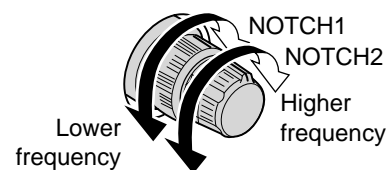

■ Front panel (continued)

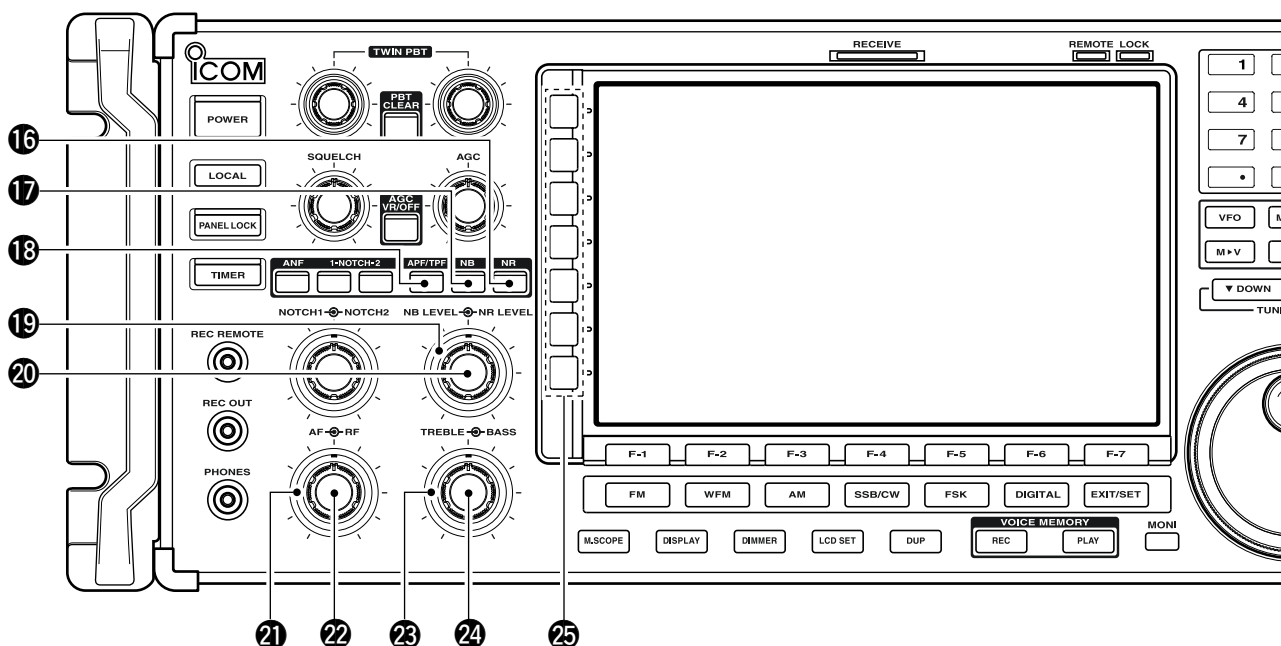

16 NOISE REDUCTION SWITCH [NR] (p. 5-16)
 Push to switch the DSP noise reduction ON or OFF.
 • The [NR] indicator above this switch lights green when the function is activated.

17 NOISE BLANKER SWITCH [NB] (p. 5-15)
 ➔ Selects from noise blanker 1, 2, or OFF when pushed. The noise blanker reduces pulse-type noise such as that generated by automobile ignition systems. This function cannot be used for FM, WFM, P25 modes or non-pulse-type noise.
 • The [NB] indicator above this switch lights green and “NB1” or “NB2” appears on the display when the function is activated.
 ➔ Enters blank-width set mode when pushed and held for 1 sec.

18 AUDIO PEAK FILTER/TWIN PEAK FILTER SWITCH [APF/TPF]
 ➔ Push to turn the audio peak filter ON or OFF during CW mode operation. (p. 4-9)
 ➔ Push to turn the twin peak filter ON or OFF during FSK mode operation. (p. 4-11)
 • “APF” appears when audio peak filter is in use.
 • “TPF” appears when twin peak filter is in use.
 ➔ During CW mode operation, push and hold for 1 sec. to select the APF passband width from 80, 160 and 320 Hz. (p. 4-9)

19 NOISE REDUCTION LEVEL CONTROL [NR LEVEL] (outer control; p. 5-16)
 Adjusts the DSP noise reduction level when noise reduction is in use. Set for maximum readability.
 • To use this control, noise reduction must be ON.

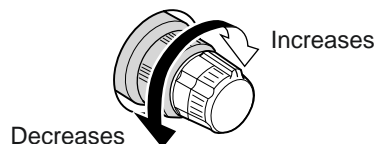

20 NOISE BLANKER CONTROL [NB LEVEL] (inner control; p. 5-15)
 Adjust the noise blanker threshold level.
 • To use this control, either noise blanker must be ON.

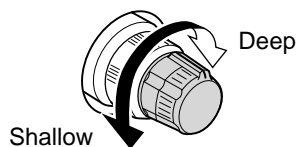

21 RF GAIN CONTROL [RF] (outer control; p. 3-8)
 Adjusts the RF gain level.
 ▨ While rotating the RF gain control, you may hear noise. This comes from the DSP unit and does not indicate a malfunction.

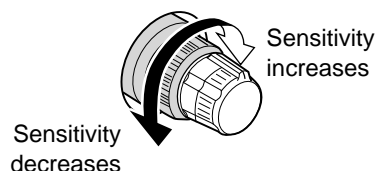

- 22 AF CONTROL [AF]** (inner control; p. 3-8)
 Varies the audio output level of the speaker or headphones.

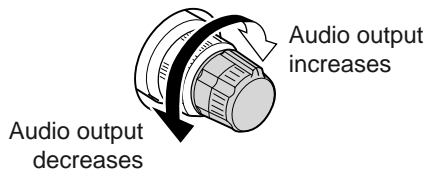

- 23 BASS RESPONSE CONTROL [BASS]**
 (outer control; p. 3-9)
 Adjusts the bass response of the audio output.

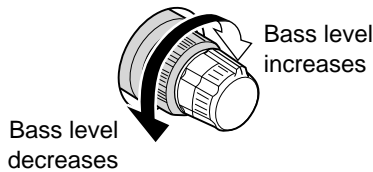

- 24 TREBLE RESPONSE CONTROL [TREBLE]**
 (inner control; p. 3-9)
 Adjusts the treble response of the audio output.

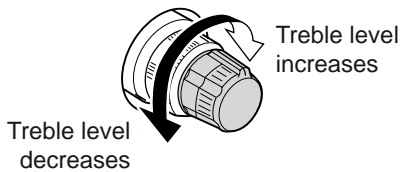

- 25 MULTIFUNCTION SWITCHES**
 Push to select the functions indicated in the LCD display to the right of these switches.
 • Functions vary depending on the operating condition.

- ANT HF 2** ➔ While operating HF bands, selects the antenna connector from HF ANT 1, HF ANT 2 and HF ANT 3 when pushed. (p. 9-3)
- During 30–1150 MHz operation, only ANT 1 is available.
 - During 1150–3335 MHz operation, only ANT 2 is available.
- ➔ Turns the antenna control voltage ON and OFF form [ANT SEL] when pushed and held for 1 sec. (p. 9-3)

- P.AMP 1** ➔ Selects one of 2 receive RF preamps or bypasses them. (p. 5-9)
- HF bands
 - “P. AMP1” activates 10 dB preamp.
 - “P. AMP2” activates high-gain preamp.
 - Above 30 MHz bands
 - Only “P. AMP” is available.

✓ **What is the preamp?**
 The preamp amplifies received signals in the front end circuit to improve S/N ratio and sensitivity. Select “P. AMP1” or “P. AMP2” when receiving weak signals.

- ATT OFF** ➔ Selects the attenuator when pushed. (p. 5-9)
- HF bands: 6, 12, 18, 24, 30 dB.
 - 30–1150 MHz: 10, 20, 30 dB.
 - 1150–3335 MHz: 20 dB only.
- ➔ Turns OFF the attenuator when pushed and held for 1 sec. (p. 5-9)

✓ **What is the attenuator?**
 The attenuator prevents a desired signal from distorting when very strong signals are near the receiving frequency, or when very strong electric fields, such as from a broadcasting station, are near your location.

- FILTER 2** ➔ Selects one of 3 IF filter settings.
 ➔ Enters the filter set screen when pushed and held for 1 sec.

- AGC MID** ➔ Activates and selects fast, middle or slow AGC time constant when pushed. (p. 5-10)
- In FM, WFM or P25 mode, only “FAST” is available.
 - “VR (volume)” indicates that AGC time constant depends on [AGC] control.
- ➔ Enters the AGC set mode when pushed and held for 1 sec. (p. 5-10)

/// AGC time constant can be set from 0.1 to 8.0 sec. (depends on mode), or turned OFF. When AGC is “OFF,” the S-meter does not function.

✓ **What is the AGC?**
 The AGC controls receiver gain to produce a constant audio output level, even when the received signal strength varies dramatically. Select “FAST” for tuning and then select “MID” or “SLOW” depending on the receiving conditions.

- TONE OFF** ➔ Switches between the tone squelch, DTCS squelch function and no-tone operation when pushed in FM mode. (p. 4-4)
 ➔ Enters the tone set mode when pushed and held for 1 sec. in FM, FSK mode. (pgs. 4-4, 4-12)

- PITCH** ➔ Push to toggle the CW pitch setting screen ON and OFF in CW mode. (p.4-9)

- D.SQL OFF** **(Requires optional UT-122)**
 ➔ Switches the digital squelch between NAC squelch, selective squelch and OFF in P25 mode. (p. 4-19)
 ➔ Enters the code set mode when pushed and held for 1 sec. in P25 mode. (p. 4-19)

- VSC OFF** ➔ Push to switch the voice squelch control function ON and OFF; useful for scanning. (p. 8-3)

■ Front panel (continued)

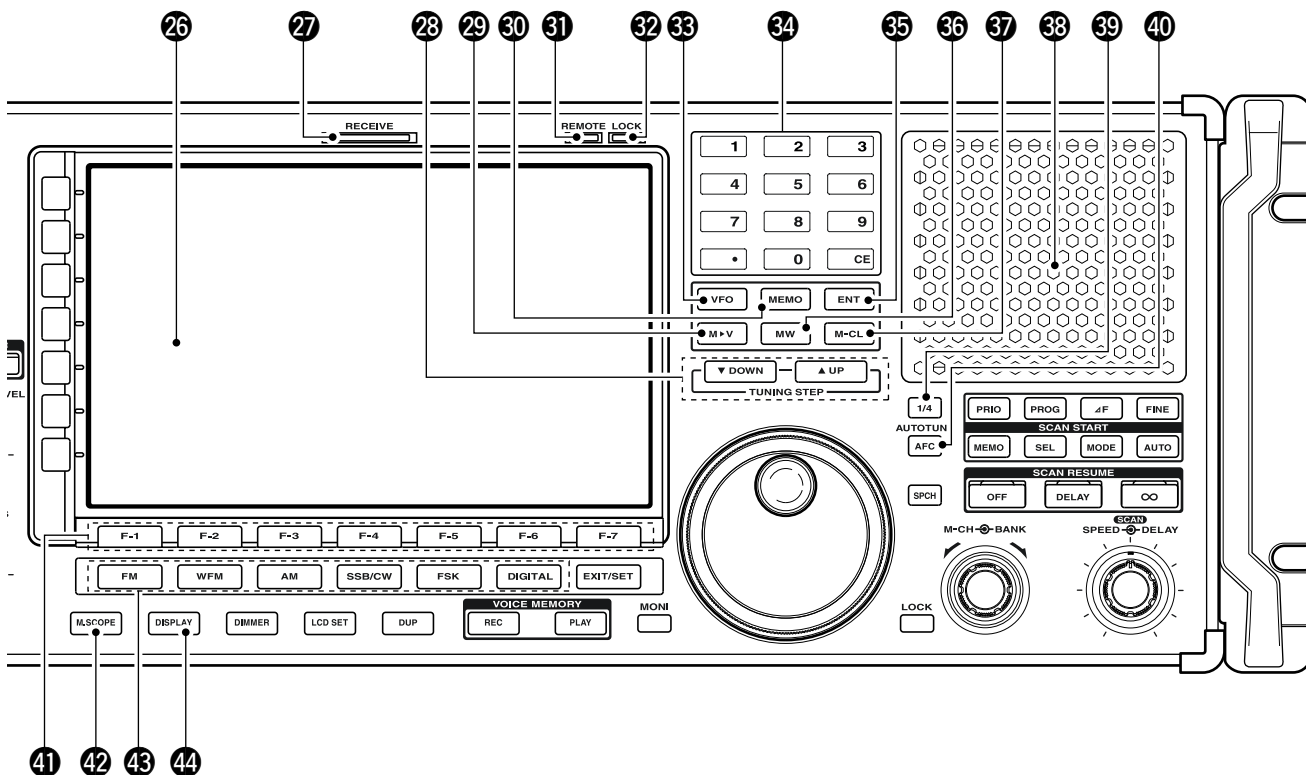

26 LCD FUNCTION DISPLAY (p. 1-10)

Shows the operating frequency, function switch menus, spectrum scope screen, memory channel screen, set mode settings, etc.

27 RECEIVE INDICATOR [RECEIVE]

Lights green while receiving a signal and when the squelch is open.

28 TUNING STEP SWITCHES [▲UP]/[▼DOWN]

(p. 3-5)

➔ Select the tuning step for the main dial. Push [▲UP] to select a larger tuning step; push [▼DOWN] to select a smaller tuning step.

- 1 Hz, 10 Hz, 100 Hz, 1 kHz, 2.5 kHz, 5 kHz, 6.25 kHz, 9 kHz, 10 kHz, 12.5 kHz, 20 kHz, 25 kHz, 100 kHz and 1 MHz are selectable.

• Programmable tuning steps can be set between 0.1 and 999.9 kHz in 0.1 kHz steps.

➔ To set programmable tuning steps, enter the desired steps via the keypad, then push [▲UP] or [▼DOWN].

➔ Push and hold [▲UP] (or [▼DOWN]) for 1 sec. to enter the tuning step select screen.

- Unwanted tuning step for each operating mode can be skipped in the tuning step select.

29 MEMORY TRANSFER SWITCH [M▶V] (p. 7-5)

Transfers the memory contents to VFO when pushed and held for 1 sec.

- This function is available both in VFO and memory modes.

30 MEMORY SWITCH [MEMO] (p.7-3)

➔ Selects the memory mode when pushed.

- After pushing one to three digit (0 to 999), pushing the switch selects a memory channel.

➔ Memory bank limit function ON or OFF when pushed and held for 1 sec.

31 REMOTE CONTROL INDICATOR [REMOTE]

Lights yellow when a command is received from a PC via CI-V data.

- When this indicator lights yellow, all dials, keys or switches other than [LOCAL] are disabled.
- This indicator goes OFF, when [LOCAL] is pushed.

32 DIAL LOCK INDICATOR [LOCK] (p. 9-2)

Lights orange when the dial lock function is activated.

33 VFO SWITCH [VFO]

Selects the VFO mode when pushed. (p. 3-3)
 • After pushing a digit switch (0 to 9), push this switch selects a VFO mode (VFO-0 to VFO-9).

34 KEYPAD (pgs. 3-3, 3-4, 7-3)

Enters a frequency or memory channel. Pushing [ENT], [VFO] or [MEMO] ends keypad input.
 • e.g. to enter 14.195 MHz, push [1] [4] [.] [1] [9] [5] [ENT].

35 ENTER SWITCH [ENT]

Enters input frequency. (pgs. 3-4)

36 MEMORY WRITE SWITCH [MW] (p. 7-4)

Stores the selected readout frequency and operating mode into the displayed memory channel when pushed and held for 1 sec.
 • This function is available both in VFO and memory modes.

37 MEMORY CLEAR SWITCH [M-CL] (p. 7-7)

Push and hold to clear the contents of displayed memory channel.

38 SPEAKER

Outputs audio signals.

39 1/4-SPEED TUNING SWITCH [1/4]

➔ Push to turn the 1/4-speed tuning function ON or OFF in CW and FSK modes. (p. 3-6)
 • “**1/4**” appears when 1/4 function is in use.
 • 1/4 function sets dial rotation to 1/4 of normal speed for fine tuning.
 ➔ Push and hold to turn the dial click function ON or OFF. (p. 9-3)

40 AFC/AUTOMATIC TUNING SWITCH [AFC-AUTOTUNE]

➔ Turns the AFC function ON or OFF in FM or WFM modes.
 • “**AFC**” appears when AFC function is in use.
 ➔ Turns the automatic tuning function ON or OFF in AM, SSB and CW modes.
 • “**AUTO TUNE**” blinks when autotune function is activate.

IMPORTANT!

When receiving a weak signal, or receiving a signal with interference, the automatic tuning function may tune the receiver to an undesired signal.

41 LCD FUNCTION SWITCHES [F-1]–[F-7]

Push to select the function indicated in the LCD display above these switches.
 • Functions vary depending on the operating condition.

42 MINI SPECTRUM SCOPE SWITCH [M.SCOPE] (p. 5-6)

➔ Turns the mini spectrum scope screen ON or OFF.
 • The mini spectrum scope screen can be displayed with another screen, such as memory or set mode screen, simultaneously.
 ➔ Turns the spectrum scope screen ON when pushed and held for 1 sec.

43 MODE SWITCHES

Selects the desired mode. (p. 3-7)
 • Announces selected mode via the speech synthesizer. (p. 11-11)



➔ Selects FM mode.



➔ Selects WFM mode.

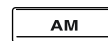

➔ Selects AM and S-AM modes alternately.
 ➔ Switches S-AM(D), S-AM(U) and S-AM(L) mode when pushed and held for 1 sec. in S-AM mode.



➔ Switches between SSB and CW mode.
 ➔ Switches between LSB and USB mode when pushed and held for 1 sec. in SSB mode.
 ➔ Switches between CW and CW-R (CW reverse) mode when pushed and held for 1 sec. in CW mode.



➔ Selects FSK and FSK-R (FSK reverse) modes alternately.



➔ Selects Digital (P25) mode. (Requires optional UT-122.)

44 DISPLAY SWITCH [DISPLAY]

➔ Push to toggle the external input screen between mini video screen, full video screen, or OFF.
 • If no signal inputs from [VIDEO IN], black screen appears.
 ➔ Enter the display set mode menu screen when pushed and held for 1 sec.

■ Front panel (continued)

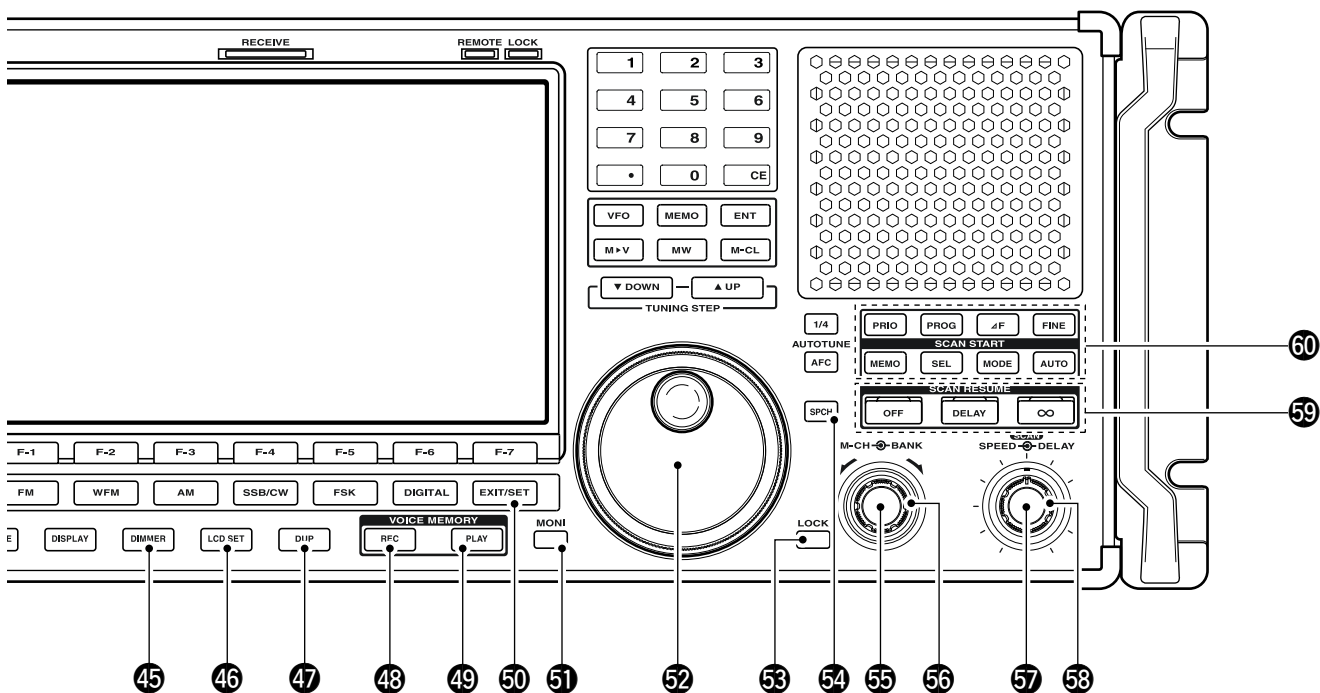

- 45 DIMMER SWITCH [DIMMER]** (p.11-26)

 - Push to turn the dimmer function ON or OFF.
 - When this function is ON, LEDs and LCD backlight become dim according to the preset setting.
 - Push and hold for 1 sec. to reset the LCD setting to the default value with the dimmer function ON and OFF.
- 46 LCD SET SWITCH [LCD SET]** (p. 11-26)

 - Push to toggle the LCD setting screen ON or OFF.
 - LCD contrast and backlight's brightness can be set.
- 47 DUPLEX SWITCH [DUP]** (p. 4-3)

 - Push to select the duplex function (DUP-, DUP+ and OFF).
 - Push and hold for 1 sec. to enter the offset frequency set mode.

- 48 VOICE MEMORY RECORD SWITCH [REC]**

 - Short recording; Push momentarily to record the signal received for the preset time period before [REC] was pushed. (p.6-5)
 - Starts recording again automatically.
 - Regular recording; Push and hold for 1 sec. to record the received signal until recording is stopped. (p. 6-3)
 - Push and hold this switch for 1 sec. to stop recording.
- 49 SHORT VOICE MEMORY PLAY BACK SWITCH [PLAY]** (p. 6-5)

 - Plays back the audio previously recorded during the preset time period when pushed.
 - Plays back all of the previously recorded audio when pushed and held for 1 sec.
- 50 EXIT/SET SWITCH [EXIT/SET]**

 - Push to exit, or return to the previous screen during spectrum scope, memory, scan or set mode screen display.
 - Displays set mode menu screen when pushed and held for 1 sec.

51 MONITOR SWITCH [MONI] (pgs. 3-8, 4-4, 4-19)

- ➔ Push and hold to open the squelch manually.
 - The [MONI] indicator appears on the display.
 - While pushing and holding this switch, release any other receiving functions such as the noise blanker or ANF.
 - While in a duplex operation, monitor the shifted frequency.

52 MAIN DIAL

Changes the displayed frequency, selects set mode setting, etc.

53 LOCK SWITCH [LOCK] (p. 9-2)

Push to turn the dial lock function ON or OFF.

54 SPEECH SWITCH [SPCH] (p. 9-2)

- ➔ Push to announce the S-meter indication and the selected readout frequency.
- ➔ The selected operating mode is also announced when pushed and held for 1 sec.

55 MEMORY DIAL [M-CH] (inner control; p. 7-3)

Rotate to select the desired memory channel.

- Memory channels can be selected both in VFO and memory modes.

56 MEMORY BANK DIAL [BANK]

(outer control; p. 7-3)

Rotate to select the desired memory bank.

- Memory banks can be selected both in VFO and memory modes.

57 SCAN SPEED CONTROL [SPEED]

(inner control; p. 8-18)

Rotate to adjust the scan speed.

58 SCAN DELAY CONTROL [DELAY]

(outer control; p. 8-18)

Rotate to adjust the desired scan delay time.

- This setting is effective when "DELAY" is selected for the scan resume condition (59).
- Scan delay time is adjustable between 2 sec. to 20 sec.

59 SCAN RESUME SWITCHES [OFF]/[DELAY]/[∞]

(p. 8-17)

Push to select a scan resume condition.

- The [SCAN RESUME] indicator lights green above the selected switch.

60 SCAN START SWITCHES

(pgs. 8-5, 8-7 to 8-11, 8-13, 8-14)

Push to start the desired scan.

1 PANEL DESCRIPTION

■ Rear panel

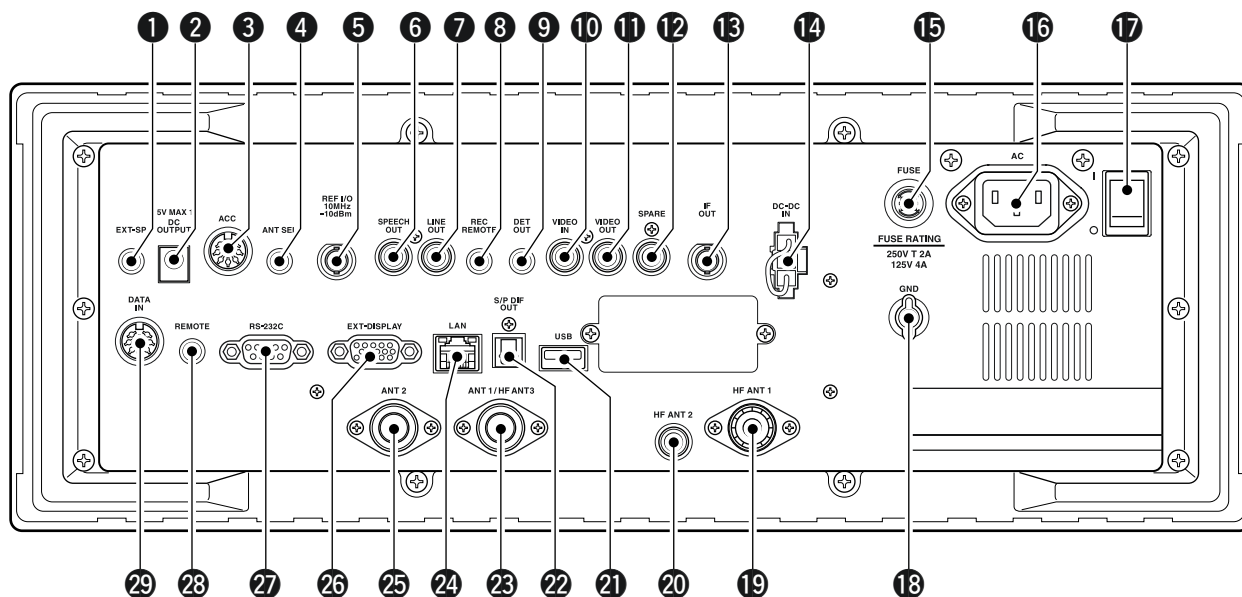

1 EXTERNAL SPEAKER JACK [EXT-SP] (p. 2-6)
Connects an external speaker (4–8 Ω), if desired.

2 DC OUTPUT JACK [DC OUTPUT] (p. 2-6)
Outputs regulated 15 V DC (approx.) for external equipment. Connected in parallel with 13.8 V outputs of [ACC]. (max. 1 A total)

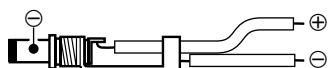

3 ACCESSORY SOCKET [ACC] (p. 2-6)
Enables connection of external equipment such as an automatic antenna selector, a TNC for data communications, etc.
• See p. 2-12 for socket information.

4 ANTENNA SELECTOR VOLTAGE OUTPUT JACK [ANT SEL]
Outputs regulated 13.8 V DC (max. 100 mA) for external preamplifier or antenna selector, etc.

5 REFERENCE SIGNAL INPUT/OUTPUT TERMINAL [REF I/O 10MHz–10dBm]
Inputs/outputs a 10 MHz reference signal.

6 SPEECH OUTPUT JACK [SPEECH OUT] (p. 2-9)
Outputs an operating frequency, mode, S-meter indication and time with a synthesized voice when pushing [SPCH] or scan stopped.
• Turn ON the “REC SPCH” in the others set mode to activate this jack when scan stopped. (p. 11-11)
• Output level can be adjusted in ACC set mode. (p. 11-7)

7 LINE OUTPUT JACK [LINE OUT]
Audio output jack for tape recorder. The fixed audio output level is set for a tape recorder AUX jack.

8 RECORDER REMOTE JACK [REC REMOTE]
Controls the operation of a tape recorder for recording. Connects to the REMOTE jack on a tape recorder.

9 DETECTOR OUTPUT JACK [DET OUT]
Outputs the detector output signal.

10 VIDEO INPUT JACK [VIDEO IN]
Accepts video signals for display on the LCD monitor when the [DISPLAY] switch is ON.

11 VIDEO OUTPUT JACK [VIDEO OUT]
Outputs video signals when TV frequencies with WFM mode are received. The NTSC M, PAL B/G, PAL I, PAL D and SECAM K system can be accepted. (No signals come out for USA versions.)

12 SPARE JACK [SPARE] (p. 2-3)
No connection.

13 IF OUTPUT JACK [IF OUT] (p. 2-3)
Outputs a 10.7 MHz IF signal.
Output level is the same level as an antenna input signal or below (when the AGC function is activated or attenuator is ON.)

14 DC-DC POWER SOCKET [DC-DC IN] (p. 2-6)
Accepts a regulated 13.5 to 15 V DC input. This socket does not accept voltage from a non-regulated power source such as a vehicle’s battery.

- 15 FUSE HOLDER [FUSE]** (p. 12-8)
Holds a 4 A fuse (100 V/120 V versions) or 2 A fuse (230 V/240 V versions) for internal AC power supply protection. Cuts off the AC input when over-current occurs.
- CAUTION:** Always use the correct fuse for AC input power. Using a fuse rated for a different input power may damage your house electrical system or the receiver.
- 16 AC POWER SOCKET [AC]** (p. 2-5)
Connects the supplied AC power cable to an AC line-voltage receptacle.
- 17 MAIN POWER SWITCH [I/O]** (p. 3-2)
Turns the internal power supply ON or OFF.
- 18 GROUND TERMINAL [GND]** (p. 2-2)
Connect this terminal to a ground to prevent electrical shocks, TVI, BCI and other problems.
- 19 HF ANTENNA CONNECTOR 1 [HF ANT 1]**
(p. 2-5)
Accepts a 50 Ω antenna for HF bands with a PL-259 plug connector.
- 20 HF ANTENNA CONNECTOR 2 [HF ANT 2]**
(p. 2-5)
Accepts a 500 Ω antenna for HF band with an RCA connector.
- 21 USB CONNECTOR [USB]**
Connects USB equipment such as a memory media, hub or keyboard.
- 22 S/P DIF OUTPUT TERMINAL [S/P DIF OUT]**
(p. 2-7)
Connects external equipment that supports S/P DIF output.
- 23 HF ANTENNA CONNECTOR 3/ANTENNA CONNECTOR 1 [ANT 1/HF ANT 3]** (p. 2-5)
Accepts a 50 Ω antenna with a Type-N connector. Covers the HF bands and 30–1150 MHz frequency range.
- 24 ETHERNET CONNECTOR [LAN]** (pgs. 2-7, 15-6)
Connects to a PC through a LAN (Local Area Network).
- 25 ANTENNA CONNECTOR 2 [ANT 2]** (p. 2-5)
Accepts a 50 Ω antenna with a Type-N connector. Covers the 1150–3335 MHz frequency range.
- 26 EXTERNAL DISPLAY TERMINAL [EXT-DISPLAY]** (p. 2-10)
Connects to an external display monitor.
• At least 800×600 pixel display is necessary.
- 27 RS-232C TERMINAL [RS-232C]** (p. 2-6)
Connects to a PC using a D-sub 9-pin RS-232C cable.
Can be used for remote control of the IC-R9500 without the optional CT-17, or the FSK decoded signal output. The [RS-232C] interface is wired as a modem (DCE).
- 28 CI-V REMOTE CONTROL JACK [REMOTE]**
(p. 2-6)
➤ Connects a PC via the optional CT-17 CI-V LEVEL CONVERTER for external control of the receiver.
➤ Used for transceive operation with another Icom CI-V transceiver or receiver.
- 29 DATA SOCKET [DATA IN]**
(pgs. 2-10, 2-12)
Outputs LCD monitor signals (NTSC system).

■ LCD display

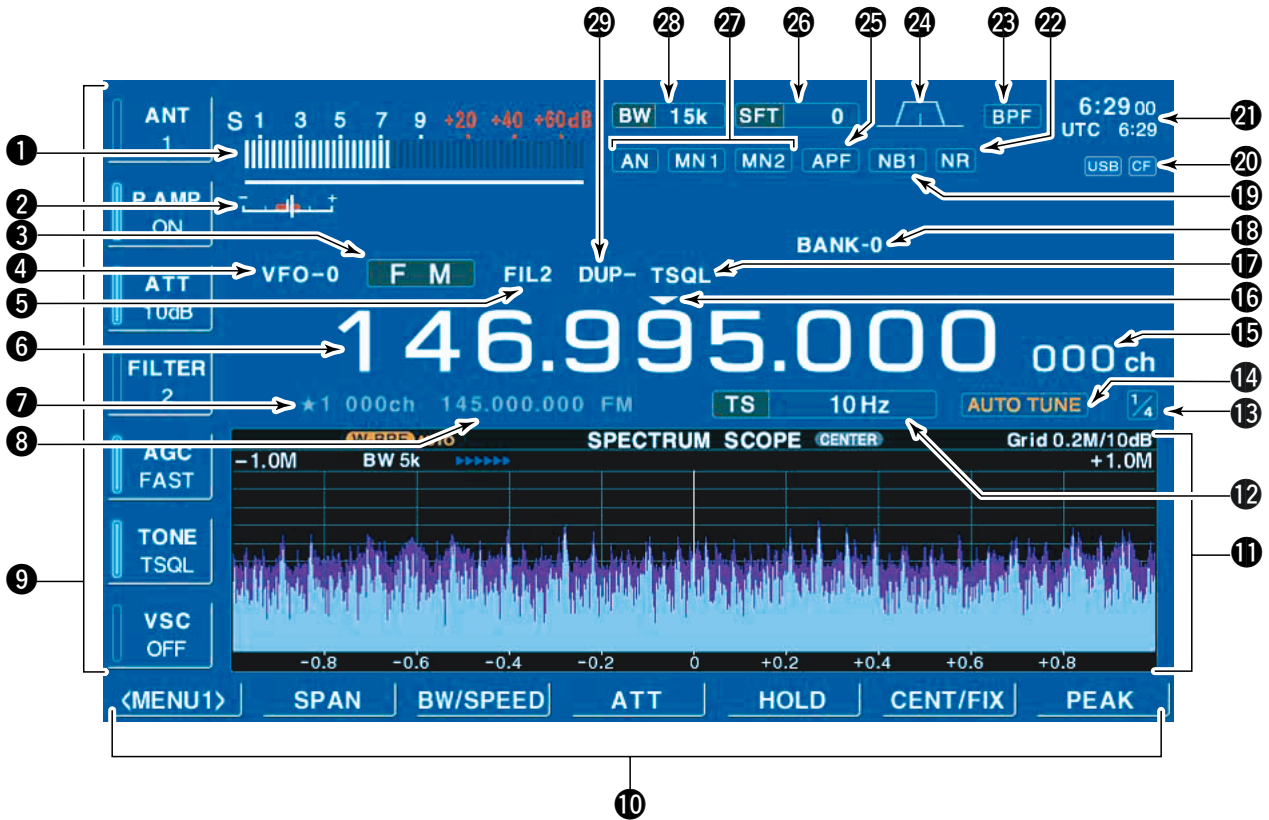

1 **RSSI (Received Signal Strength Indication) METER** (p. 3-10)

Shows the received signal strength. Four meter types, S, dBμ, dBμ(EMF) and dBm meters are selectable.

- S-meter



- dBμ meter

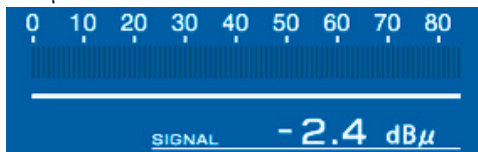

- dBμ (EMF) meter

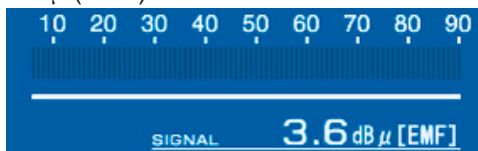

- dBm meter

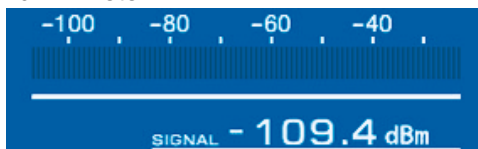

2 **CENTER METER**

Shows that the received signal is tuned to its center frequency for FM, WFM or FSK modes.

- FM/WFM modes
- FSK mode



3 **MODE INDICATOR** (p. 3-7)

Shows the selected receive mode.

4 **VFO/MEMORY INDICATOR** (pgs. 3-3, 7-3)

Indicates the selected VFO number (VFO-0 to VFO-9) or memory mode.

5 **IF FILTER INDICATOR** (p. 5-12)

Shows the selected IF filter number.

6 **FREQUENCY READOUTS**

Shows the operating frequency.

7 **SELECT MEMORY CHANNEL INDICATOR** (p. 8-12)

Indicates the displayed memory channel is set as a select memory channel.

8 **MEMORY CHANNEL READOUTS**

- Shows the selected memory channel contents in VFO mode.
- Shows the VFO contents in memory mode.

- 9 MULTIFUNCTION SWITCH GUIDE**
Indicates the function of the multifunction switches.
- 10 LCD FUNCTION SWITCH GUIDE**
Indicates the function of the LCD function switches ([F-1] – [F-7]).
- 11 MULTIFUNCTION SCREEN**
Shows the screens for the spectrum scope, voice recorder, memory channel list, scan, FSK decoder, IF filter selection or set modes, etc.
- 12 TUNING STEP INDICATOR** (p. 3-5)
Shows the selected tuning step.
- 13 1/4 FUNCTION INDICATOR** (p. 3-6)
Appears when the 1/4-speed tuning function is activated in CW and FSK modes.
- 14 AUTOMATIC TUNE INDICATOR** (p. 5-17)
“**AUTO TUNE**” blinks during automatic tuning. This feature is active in AM, SSB and CW mode.
- 15 MEMORY CHANNEL INDICATOR** (p. 7-3)
Indicates the selected memory channel number.
- 16 TUNING DIGIT INDICATOR** (p. 3-5)
Shows the tuneable digit when rotating the main dial.
- 17 TONE/DTCS/NAC/SELECTIVE SQUELCH INDICATOR**

 - ➔ “**TSQL**” or “**DTCS**” appears when the tone squelch or DTCS squelch is set in FM mode. (p. 4-4)
 - ➔ “**NAC**” or “**SEL**” appears when the NAC squelch or selective squelch is selected in P25 mode. (Requires optional UT-122.) (p.4-19)
- 18 BANK INDICATOR** (p. 7-3)
Appears when the bank limit function is in use and indicates the selected bank number.

 - BANK-0 to BANK-9, BANK-A (AUTO MW), BANK-S (SKIP) and BANK-P (SCAN EDGE) are selectable.
- 19 NOISE BLANKER INDICATOR** (p. 5-15)
“**NB1**” or “**NB2**” appears when either noise blanker 1 or noise blanker 2 is ON. This function is not available for FM, WFM or P25 mode.
- 20 CF CARD/USB-MEMORY INDICATOR** (p. 11-16)

 - ➔ “**CF**” appears when CF card is correctly connected and blinks while CF card is active.
 - This indicator is normally stayed ON.
 - ➔ “**USB**” appears when USB equipment (USB-Memory or keyboard, etc) is connected, and blinks while it is active.
- 21 CLOCK READOUT** (p. 10-2)
Shows the current time. Local and UTC time can indicate at the same time.
- 22 NOISE REDUCTION INDICATOR** (p. 5-16)
Appears when noise reduction function is in use.
- 23 BANDPASS FILTER INDICATOR**
Appears when the narrow filter (500 Hz or less) is selected during CW or FSK operation.
- 24 PASSBAND WIDTH INDICATOR** (p. 5-11)
Graphically displays the passband width for twin PBT operation and center frequency for IF shift operation.
- 25 AUDIO PEAK FILTER INDICATOR** (p. 4-9)
Appears when the audio peak filter function is in use. This function is available in CW mode
- 26 SHIFT FREQUENCY INDICATOR** (p. 5-11)
Shows the shift frequency of the IF filter.
- 27 NOTCH FILTER INDICATOR** (p. 5-16)

 - ➔ “**AN**” appears when the auto notch function is in use. This function is available in FM, WFM, AM and SSB modes.
 - ➔ “**MN1**” or “**MN2**” appears when the manual notch filter function is in use. This function is available in AM, SSB, CW and FSK mode.
- 28 BAND WIDTH INDICATOR** (p. 5-11)
Shows the passband width of the IF filter.
- 29 DUPLEX INDICATOR** (p. 4-3)
“**DUP-**” or “**DUP+**” appears when the negative duplex or positive duplex operation is selected, respectively.

1 PANEL DESCRIPTION

■ Screen menu arrangement

The following screens can be selected from the start up screen. Choose the desired screen using the following chart.

Pushing [EXIT/SET] several times returns to the start up screen. See p. 11-3 for set mode arrangement.

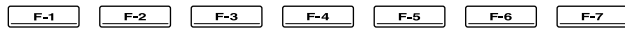

• Spectrum scope screen (p. 5-2)

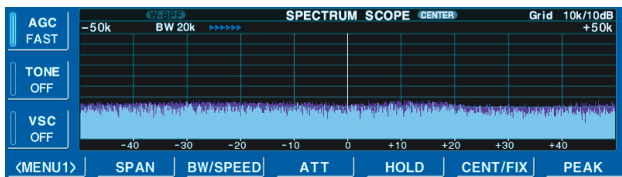

• Memory channel screen (p. 7-4)

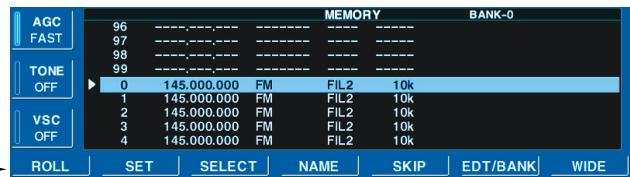

• Voice recorder screen (p. 6-3)

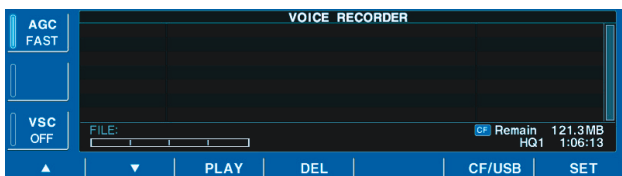

• Scan screen (p. 5-5)

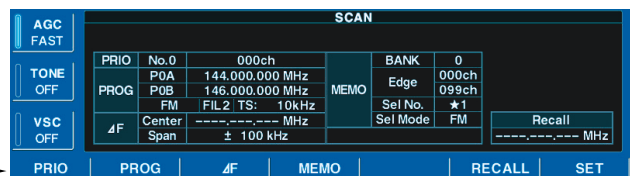

• FSK decoder screen (p. 4-14)

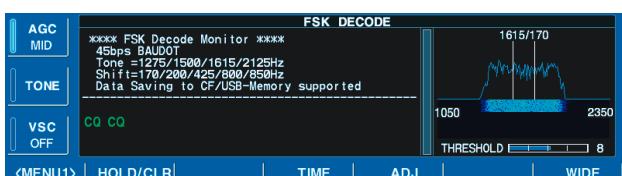

• Set mode menu screen (p. 11-2)

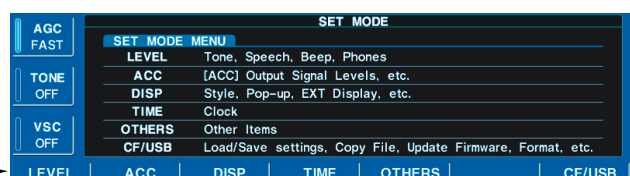

■ Unpacking	2-2
■ Selecting a location	2-2
■ Grounding	2-2
■ Antenna connection	2-3
■ TV jumper cable connection (except for USA versions)	2-4
■ Carrying handle attachment	2-4
■ Rack mounting handle detachment	2-4
■ Required connections	2-5
◇ Rear panel	2-5
■ Advanced connections	2-6
◇ Front panel	2-6
◇ Rear panel—1	2-6
◇ Rear panel—2	2-7
■ Tape recorder connections	2-8
◇ Recording from the front panel or rear panel	2-8
◇ Separately recording audio and frequency	2-9
■ Monitor display connection	2-10
■ Transceive function	2-10
■ FSK and AFSK (SSTV) connections	2-11
■ Accessory connector information	2-12

 **CAUTION!:** The receiver weighs approx. 20 kg (44 lb). Always have two people available to carry, lift or turn over the receiver.

■ Unpacking

After unpacking, immediately report any damage to the delivering carrier or dealer. Keep the shipping cartons.

For a description and a diagram of accessory equipment included with the IC-R9500, see 'Supplied accessories' on p. iii of this manual.

■ Selecting a location

Select a location for the receiver that allows adequate air circulation and access to the front and rear panels. Do not place in areas subject to extreme heat, cold, or vibrations, or near TV sets, radios and other electromagnetic sources.

■ Grounding

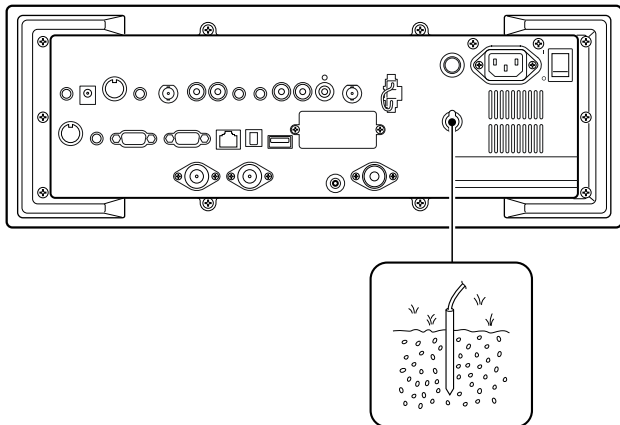

To prevent electrical shock, television interference (TVI), broadcast interference (BCI) and other problems, ground the receiver through the GROUND terminal on the rear panel.

For best results, connect a heavy gauge wire or strap to a long earth-sunk copper rod. Make the distance between the [GND] terminal and ground as short as possible.

⚠ WARNING: NEVER connect the [GND] terminal to a gas or electric pipe, since the connection could cause an explosion or electric shock.

■ Antenna connection

Your antenna plays a very important role in receiver operation. If the antenna is poor, your receiver cannot give you the best performance.

The IC-R9500 requires at least 2 antennas (ANT 1/HF ANT 3, ANT 2) for full coverage from 100 kHz to 3335 MHz. Select an antenna, such as a well matched 50 Ω antenna and feedline. When you wish to use a long wire antenna for short wave bands, use one as long as possible (at least 10 m, 32.8 ft).

CAUTION: Protect your receiver from lightning by using a lightning arrester.

PL-259 CONNECTOR INSTALLATION EXAMPLE

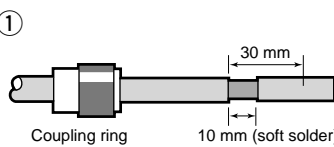
①  Slide the coupling ring down. Strip the cable jacket and tin the braid.

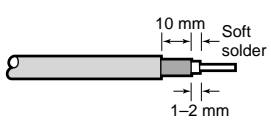
②  Strip the cable as shown at left. Tin the center conductor.

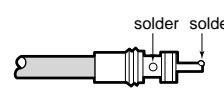
③  Slide the connector body on and solder it.

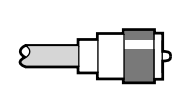
④  Screw the coupling ring onto the connector body.

30 mm ≈ 3/8 in 10 mm ≈ 3/8 in 1-2 mm ≈ 1/16 in

TYPE-N CONNECTOR INSTALLATION EXAMPLE

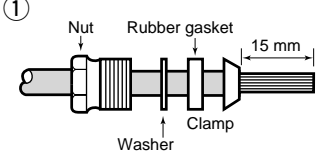
①  Slide the nut, washer, rubber gasket and clamp over the coaxial cable, then cut the end of the cable evenly.

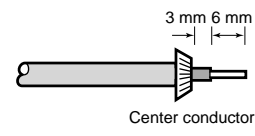
②  Strip the cable and fold the braid back over the clamp.

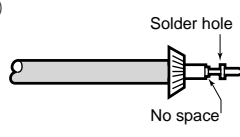
③  Tin the center conductor. Install the center conductor pin and solder it.

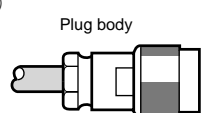
④  Carefully slide the plug body into place aligning the center conductor pin on the cable. Tighten the nut onto the plug body.

- Be sure the center pin is flush with the end of the plug body.

15 mm ≈ 19/32 in 6 mm ≈ 1/4 in 3 mm ≈ 1/8 in

Required connections

◇ Rear panel

[VIDEO IN], [VIDEO OUT]

TV jumper cable must be connected when internal TV tuner and LCD are in use (except USA versions).
No signals come out from [VIDEO OUT] for USA versions.

Ground (p. 2-2)

Ground connection

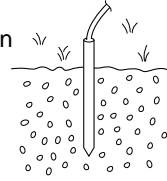

AC outlet

⚠ WARNING:
Use the supplied AC power cable only.

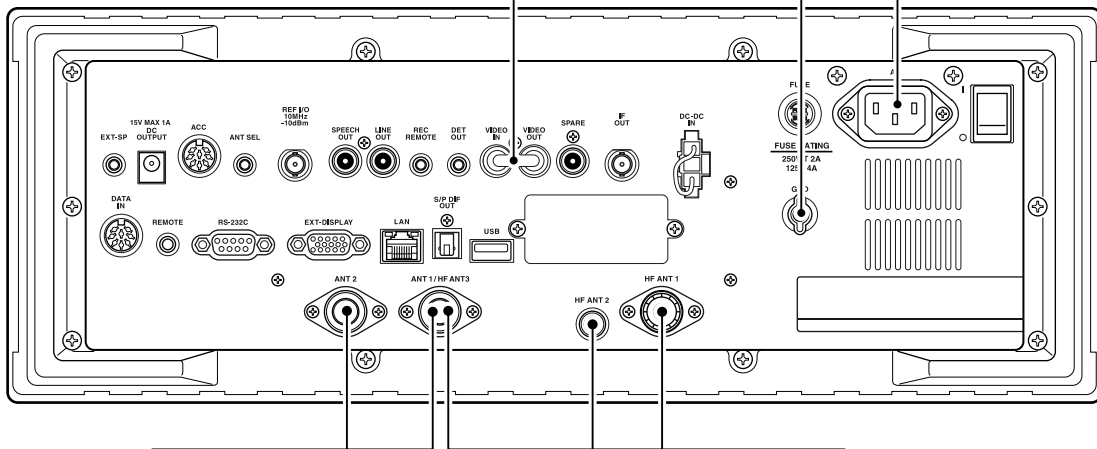

Antenna 1, 2 (p. 2-3)

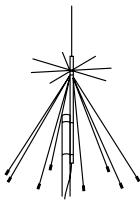

Connects the VHF, UHF wide band antennas.

ANT1: 30–1150 MHz,
ANT2: 1150–3335 MHz

HF Antenna 1, 2, 3 (p. 2-3)

[Example]: HF ANT1 for 3.5, 7 MHz bands, HF ANT 2 for 14, 18 MHz bands, ANT3 for 24, 28 MHz band.

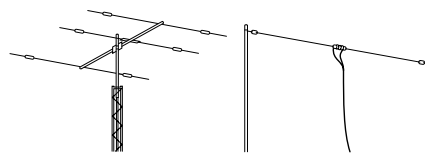

Select the active antenna connector. (p.9-3)

Advanced connections

Front panel

[REC REMOTE], [REC OUT] (p. 2-8)
Connects a tape recorder or other audio equipment.

Headphones
Accepts headphones with 8–16 Ω impedance.

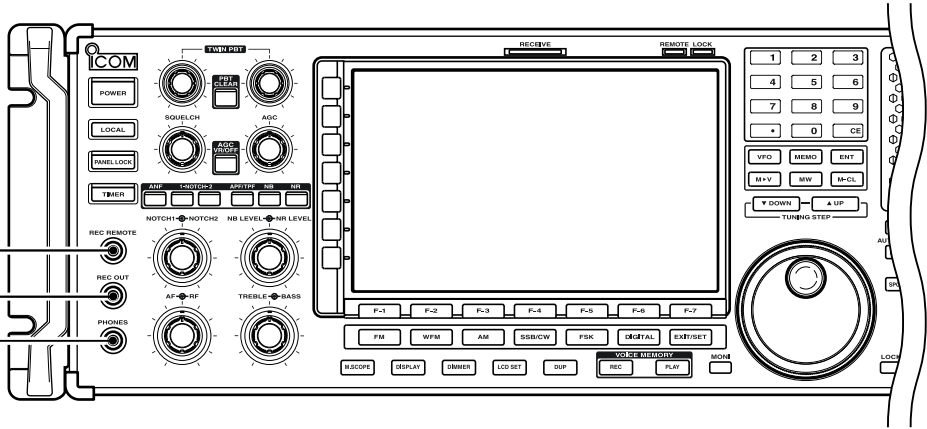

Rear panel—1

External speaker (p. 14-4)
SP-20 (option)

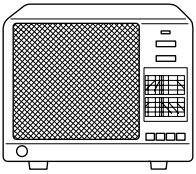

[DC OUTPUT]
Outputs regulated 15 V (approx.) DC for external equipment power supply. (max. 1 A capacity)

[DC-DC IN]
Connects an external power supply (DC 13.5–15 V at least 10 A). Only regulated DC power may be connected.

ACC socket
(pgs.2-12)

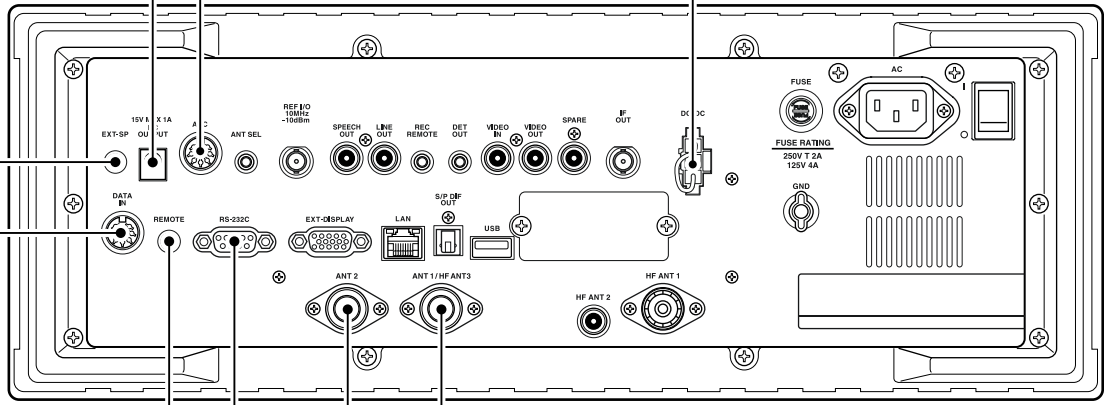

DATA socket
(pgs.2-12)

Antenna 1, 2
Connects a pre-amplifier, converter, etc.

[REMOTE], [RS-232C] (p. 13-2)
Used for computer control and transceive operation. The optional CT-17 is required when connecting a PC to [REMOTE].

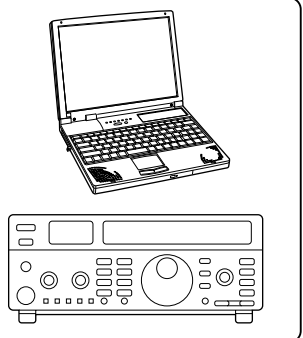

◇ Rear panel—2

[METER]
Connects an external meter, etc.

ANT SEL

When the [ANT] switch is ON:
13.8 V DC output 100 mA max.

Video equipment
Connects a video re-
corder, etc.

* No signals come out from [VID-
EO OUT] for USA versions.

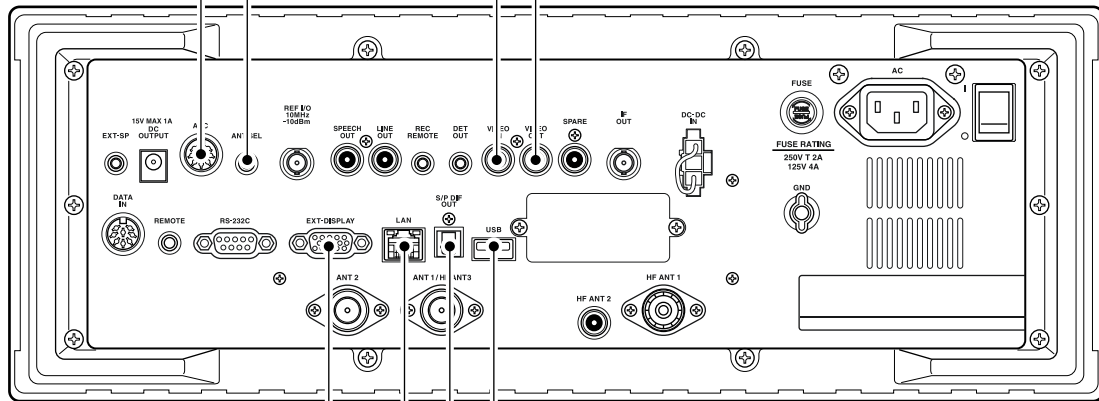

External Display

Connects a PC-style monitor display (at least 800×600 resolution). Video output signal can be turned ON and OFF in set mode (p. 11-9)

[S/P DIF IN/OUT]

Connects a PC for audio signal data (48 kHz, 16-bit) output.

[USB]

Connects a USB equipment such as memory, hub or keyboard.

Ethernet connector (p. 15-6)

Connects a PC via a LAN for CPU firmware update.

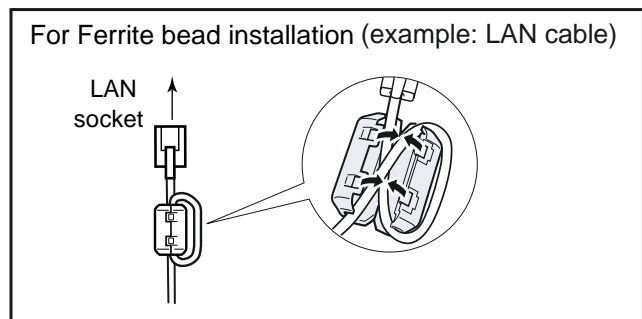

■ Tape recorder connections

The [REC REMOTE] jack is grounded when a signal is received and squelch opens. If a tape recorder has a control terminal, this jack can be used for recording control. (2 A/DC max.)

The [REC OUT] or [LINE OUT] jack has 350 mV rms/4.7 kΩ output for connection to other audio equipment.

◇ Recording from the front panel or rear panel

The [REC REMOTE] jack is grounded when a signal is received and squelch opens. If a tape recorder has a control terminal, this jack can be used for recording control. (2 A/DC max.)

The [REC OUT] or [LINE OUT] jack has 350 mV rms/4.7 kΩ output for connection to other audio equipment.

• Recording from the front panel

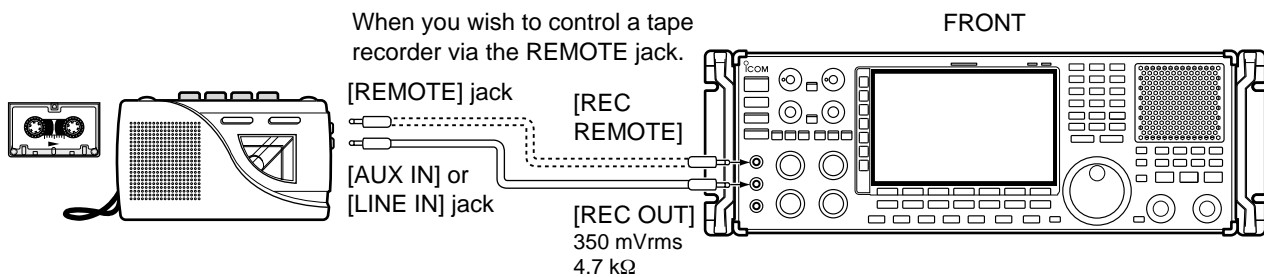

• Recording from the rear panel

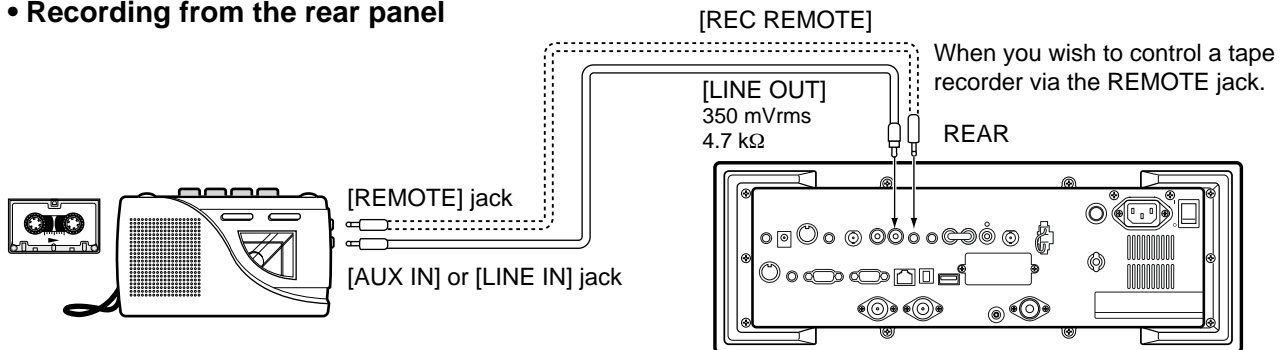

◇ Separately recording audio and frequency

When using a stereo tape recorder for recording, received audio and a frequency with a synthesized voice can be separately recorded.

When recording this way, you can search ahead of the audio signal recorded in the tape recorder using the frequency recording channel search.

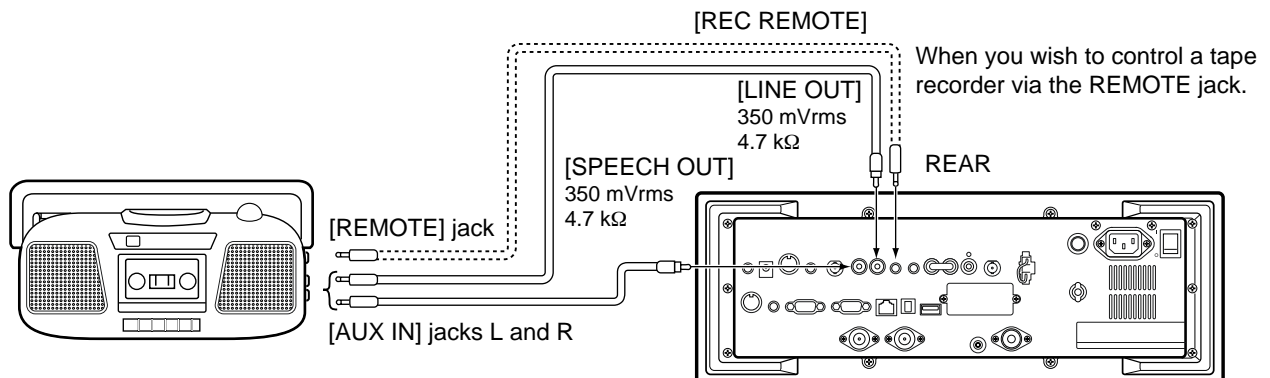

- Be sure the "REC SPEECH" item is turned ON, and "SPEECH Mix" item is select OFF in the others set mode (p. 11-11).

■ Monitor display connection

A monitor display can be connected to the IC-R9500 via the [DATA IN] socket and [EXT-DISPLAY]. You can monitor the LCD monitor information on a large size display.

The IC-R9500 includes a picture signal decoder. When connecting a TV set equipped with a VIDEO IN jack, you can monitor TV signals such as amateur TV.

NOTE: Video output from [DATA IN] is available as NTSC system only.

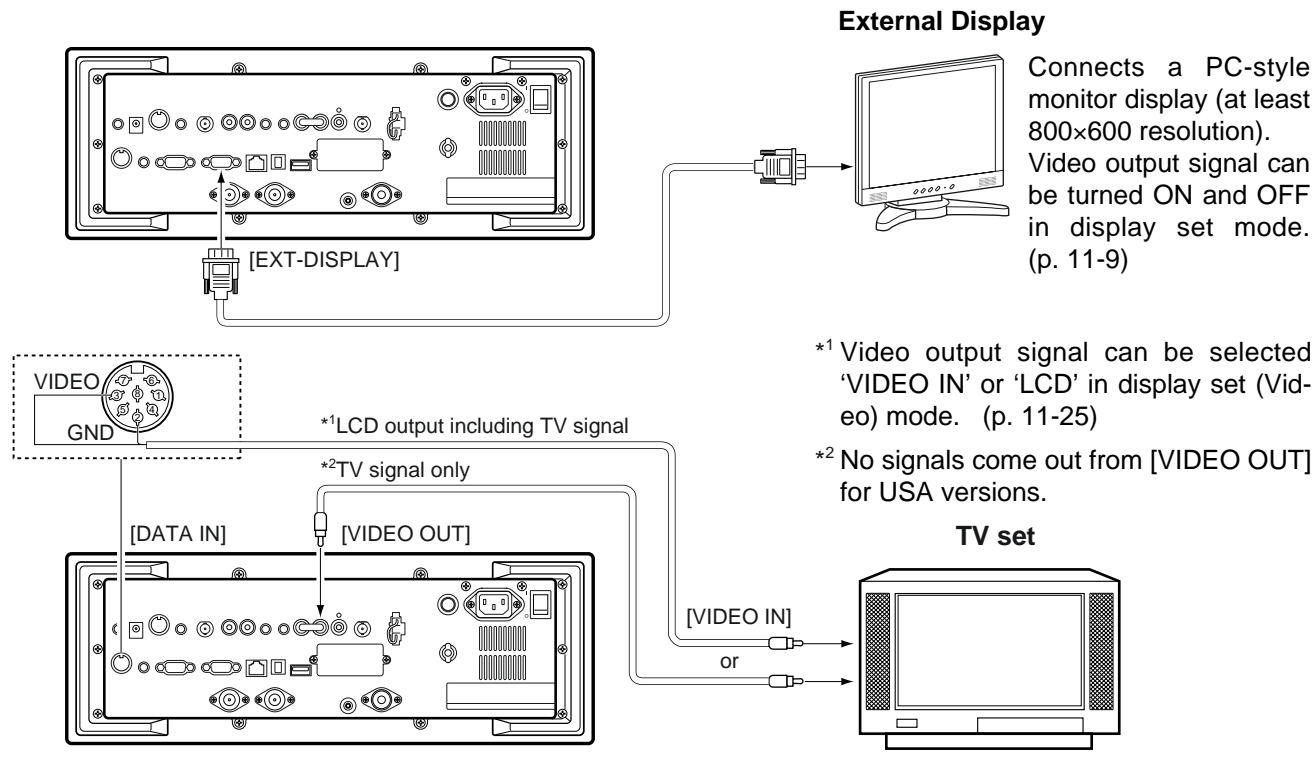

■ Transceive function

Icom CI-V transceivers or receivers can be connected via the [REMOTE] jack. The frequency and mode settings will follow* when either radio is changed.

* When a set frequency is out-of-range for one of the connected transceivers or receivers, the connected radio's frequency/mode does not change.

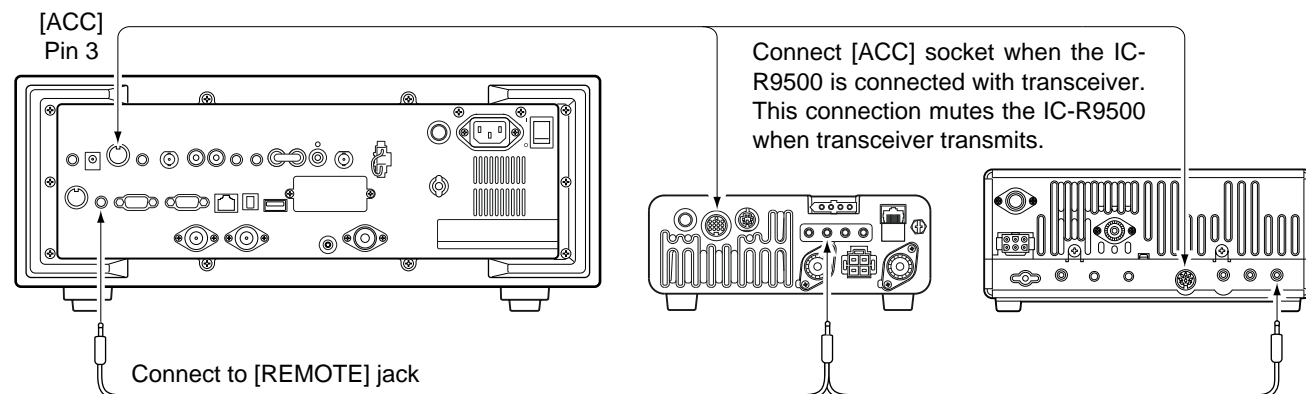

• Be sure the "CI-V Transceive" item is turned ON in the others set mode (p. 11-14).

■ FSK and AFSK (SSTV) connections

To connect a terminal unit, TNC or scan converter, refer to the diagram below.

- ① Connect a terminal unit as below.
- ② Select FSK mode (or USB, CW modes for HF band data communications).
- ③ Set the receiver to the desired frequency as shown to the right.
- ④ Set the connected terminal unit to the appropriate settings.
 - Refer to the terminal unit's instructions.

/// The narrow filter settings may not pass FSK signals. Be sure to select the appropriate IF filters corresponding to the signal width. (p. 5-12)

• **Frequency settings depend on the mode used.**

FM mode:

$$[\text{Setting frequency (displayed freq.)}] = [\text{Desired freq.}]$$

USB mode:

$$[\text{Setting frequency (displayed freq.)}] = [\text{Desired freq.}] - [\text{Center of Mark and Space freq.}]$$

CW narrow mode:

$$[\text{Setting frequency (displayed freq.)}] = [\text{Desired freq.}] - [\text{Center of Mark and Space freq.}] + [600 \text{ Hz}]$$

LSB mode (for amateur RTTY):

$$[\text{Setting frequency (displayed freq.)}] = [\text{Desired freq.}] + [\text{Mark freq.}]$$

• **When using a PC application**

Rear panel view

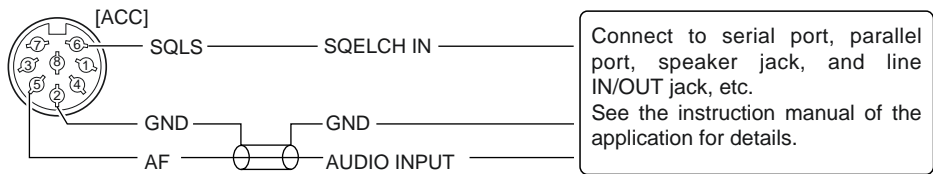

• **When using a TNC**

Rear panel view

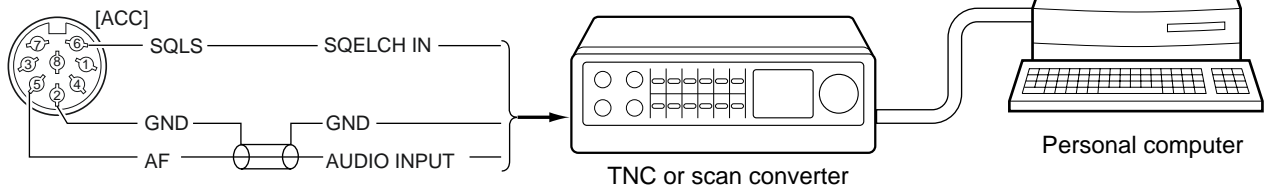

■ Accessory connector information

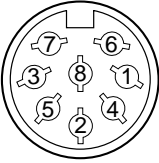
ACC	PIN No.	NAME	DESCRIPTION	SPECIFICATIONS
	1	ANTS	Outputs 5 V when the [ANTENNA] switch is ON.	Output current : Less than 100 μ A Output impedance : 10 k Ω
	2	GND	Connects to ground.	
	3	SEND	When grounded, attenuator activates and then audio is muted.	GROUND level : -0.5 to +0.8 V Input current : Less than 20 mA
	4	NC	No connection	
	5	AF	AF detector output. Fixed, regardless of [AF] position in default settings. (see notes below)	Output impedance : 47 k Ω Output level : 100–300 mV rms
	6	SQLS	Squelch output. Goes to ground when squelch opens.	Squelch open : Less than 0.3 V/5 mA Squelch closed : More than 6.0 V/100 μ A
	7	13.8 V	13.8 V output when power is ON.	Output current : 100 mA
	8	MOUT	Output S-meter level.	Output voltage : 0 to approx. 4 V Output impedance : 10 k Ω

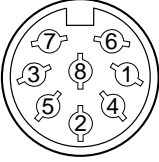
DATA IN	PIN No.	NAME	DESCRIPTION	SPECIFICATIONS
	1	DATA IN	—	
	2	GND	Connects to video ground.	
	3	VIDEO	Video signal output. (NTSC system only)	Output level : 1 V p-p \pm 0.2 V Output impedance : 75 Ω
	4	GND	—	
	5	NC	No connection	
	6	DATA OUT	—	
	7, 8	NC	No connection	

NOTE: If the beep level limit is in use, the beep tone decreases from the fixed level when the [AF] control is rotated above a specified level. (p. 11-6)

■ When first applying power (CPU resetting)	3-2
■ Initial settings	3-2
■ Selecting VFO mode	3-3
■ Selecting memory mode	3-3
■ Frequency setting	3-4
◇ Direct frequency entry with the keypad	3-4
◇ Tuning with the main dial	3-5
◇ Selecting a tuning step	3-5
◇ Auto tuning step function	3-6
◇ 1/4 tuning step function	3-6
■ Operating mode selection	3-7
■ Volume setting	3-8
■ RF gain adjustment	3-8
■ Squelch level adjustment	3-8
■ Audio tone adjustment	3-9
◇ Treble level adjustment	3-9
◇ Bass level adjustment	3-9
■ Meter indication selection	3-10
◇ Meter type selection	3-10

■ When first applying power (CPU resetting)

Before first applying power, make sure all connections required for your system are complete by referring to Section 2. Then, reset the receiver using the following procedure.

Resetting **CLEARs** all programmed contents in memory channels and returns programmed values in set mode to default values.

- ① Turn the main power ON with [I/O] on the rear panel.
 - The receiver power is still OFF and the [POWER] indicator lights orange.
- ② While pushing and holding [CE] and [M-CL], push [POWER] to turn power ON.
 - The CPU is reset.
 - The CPU start-up takes approx. 5 sec.
 - The receiver displays its initial VFO frequencies when resetting is complete.
- ③ Change the set mode settings after resetting, if desired.

In cooler temperatures, the LCD may appear dark and unstable after turning power ON. This is normal and does not indicate any equipment malfunction.

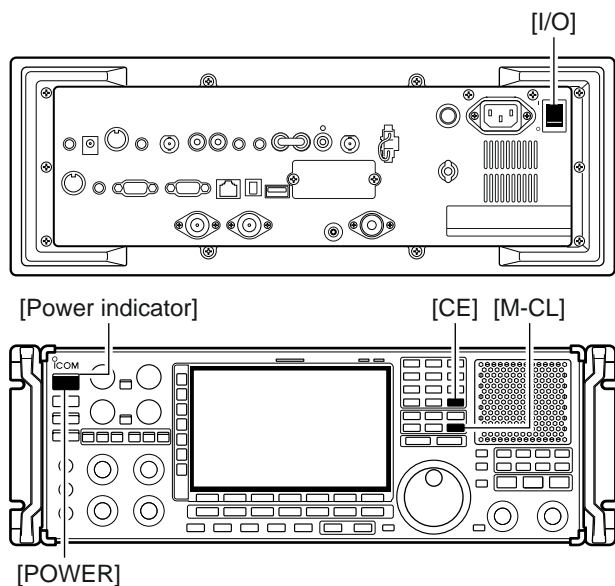

■ Initial settings

After resetting the receiver, set controls as shown in the figure below.

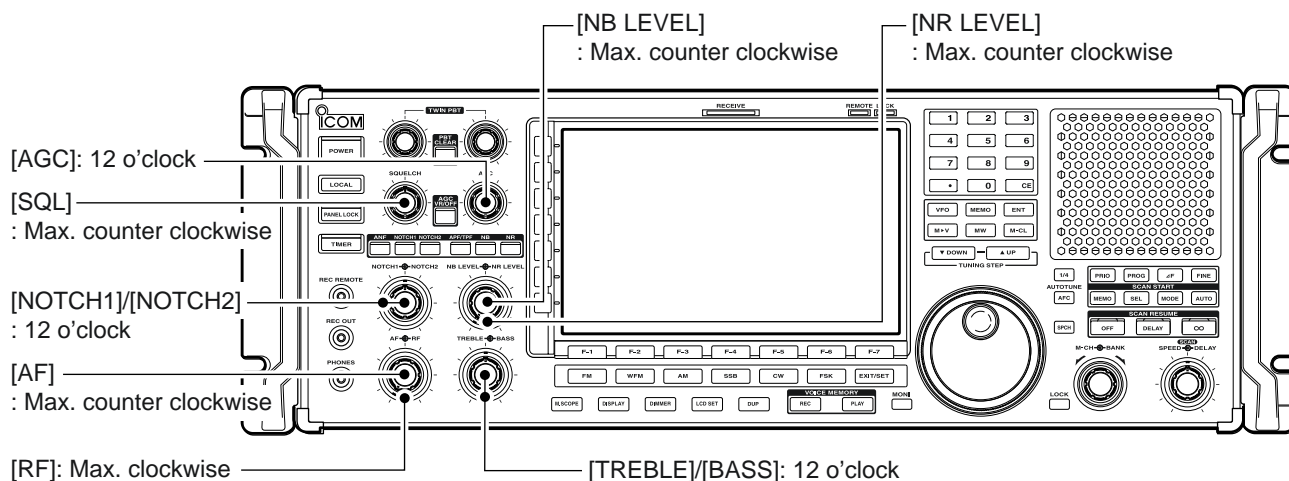

■ Selecting VFO mode

VFO is an abbreviation of Variable Frequency Oscillator, and is commonly referred to as a main tuning function. Frequency, mode and other receiver settings are stored as a set of VFO data.

The main dial is often called the “VFO knob.”

The IC-R9500 stores ten sets of VFO data. You can use the desired VFO to call up a frequency and operating mode for operation.

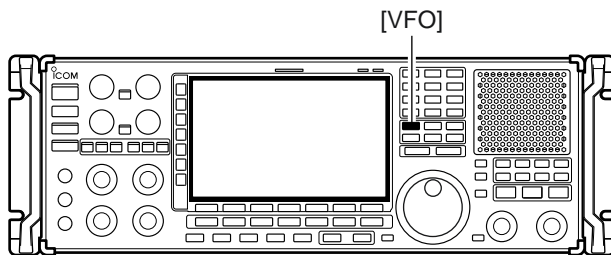

- ➔ Push [VFO] to select (last selected) VFO mode.
 - One of “**VFO-0**” to “**VFO-9**” appears when in VFO mode.
- ➔ Push the desired VFO number (0 to 9) using the keypad, then push [VFO] to select the desired VFO mode.
 - One of “**VFO-0**” to “**VFO-9**” appears when in VFO mode.



■ Selecting memory mode

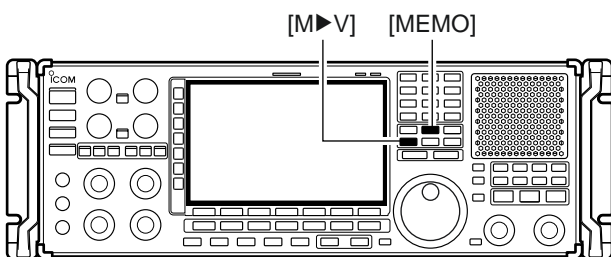

- ➔ Push [MEMO] to select memory mode.
 - The memory indicator appears when in memory mode.
 - Pushing and holding [M▶V] for 1 sec. transfers the contents of the selected memory channel to VFO*. (p. 7-5)
 - *Only last selected VFO (VFO-0 to VFO-9) is overwritten.



Frequency setting

There are two ways to set a frequency: with the main dial or keypad. Use both in combination for quick tuning.

- If the panel lock function is activated, the panel lock indicator lights, and any switches, keys and controls do not function. In this case, push [PANEL LOCK] to deactivate the panel lock function. (see p. 9-2 for details)
- The dial lock function also locks the main dial. To deactivate the dial lock function, push [LOCK].

Direct frequency entry with the keypad

The receiver has a keypad for direct frequency entry as described below.

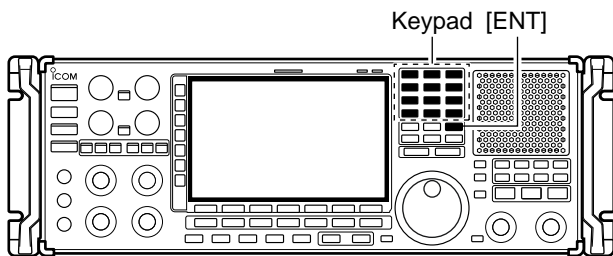

- ① Input the desired frequency.
 - Push [.] to input “. (decimal point)” between the MHz units and kHz units.
- ② Push [ENT] to set the input frequency.
 - To cancel the input, push [CE] instead of [ENT].

[EXAMPLE]

145.000000 MHz

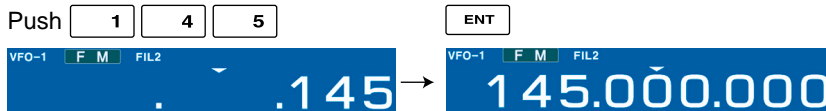

1296.24000 MHz

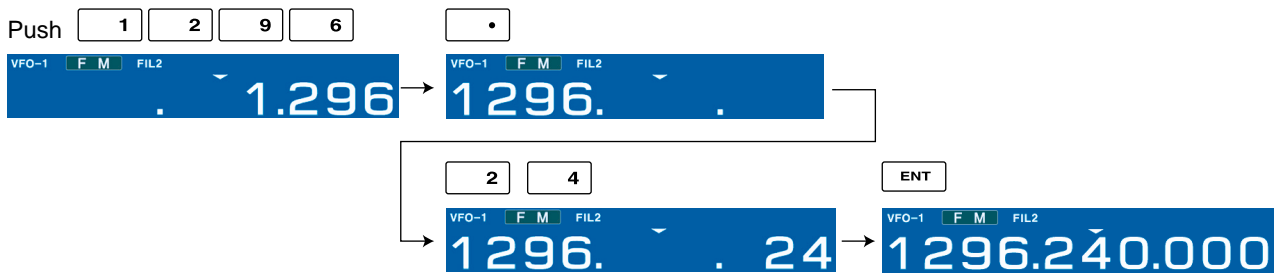

1296.24000 MHz ⇒ 1296.36000 MHz



850 kHz (0.85 MHz)



◇ Tuning with the main dial

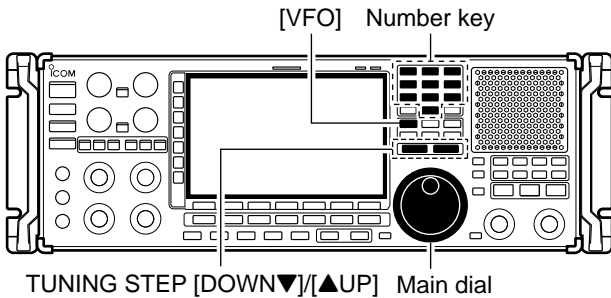

Rotate the main dial to change the frequency.
 • The frequency changes in increments determined by the selected tuning step (see below).

- ① Push the desired VFO number (0 to 9) and [VFO].
 • 10 different sets of VFO data can be selected.
- ② Select the desired operating mode. (p.3-7)
 • 10 different sets of VFO data can be selected.
- ③ Push [▲UP] or [▼DOWN] to select the desired tuning step.
 • Selectable tuning steps can be changed for each operating mode as shown below.
- ④ Rotate the main dial to set the desired frequency.

◇ Selecting a tuning step

14 preset tuning steps plus 1 programmable tuning step are available. As a default setting, selectable tuning steps can be programmed, depending on the operating mode. Selectable tuning steps can be changed in TS select screen.

• Selecting selectable tuning steps

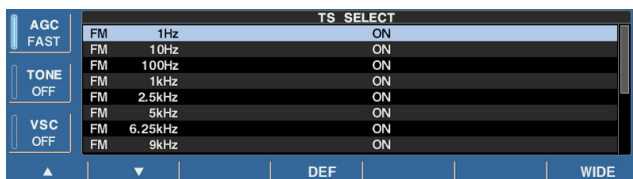
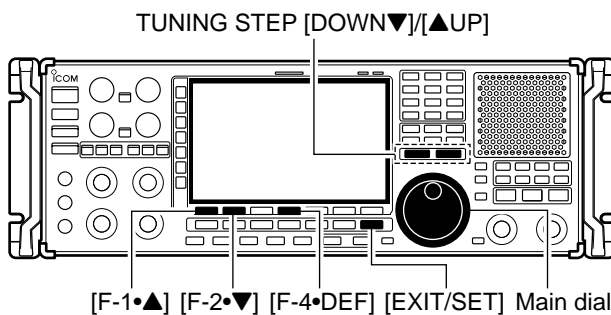

- ① Push and hold [▲UP] or [▼DOWN] for 1 sec. to enter the TS select screen to set the selectable tuning steps for each operating mode.
- ② Select the desired operating mode. (p.3-7)
- ③ Push [F-1 ▲] or [F-2 ▼] to select the desired tuning step.
 • 1 Hz, 10 Hz, 100 Hz, 1 kHz, 2.5 kHz, 5 kHz, 6.25 kHz, 9 kHz, 10 kHz, 12.5 kHz, 20 kHz, 25 kHz, 100 kHz, 1 MHz and programmable are selectable.
- ④ Rotate the main dial to set the tuning step as the selectable tuning step if desired.
 • Push and hold [F-4•DEF] for 1 sec. to select the default setting.
- ⑤ Repeat steps ③ to ④ to choose the selectable tuning steps.
- ⑥ Repeat steps ② to ④ to set the selectable tuning steps for each operating mode.
- ⑦ Push [EXIT/SET] (or [▲UP]/[▼DOWN]) to exit the TS select screen.

Default settings

- FM : All ON
- WFM : 20 k, 25 k, 100 k, 1 M, ProgTS
- AM : 1 k, 5k, 9 k, 10 k, 1 MHz
- SSB : 1, 10, 1 k, 1 MHz
- CW : 1, 10, 1 k, 1 MHz
- FSK : 1, 10, 1 k, 1 MHz
- P25 : 1 k, 2.5 k, 5 k, 6.25 k, 10 k, 12.5 k, 20 k, 25 k, 100 k, 1 MHz

3 BASIC OPERATIONS

• Setting the programmable tuning step

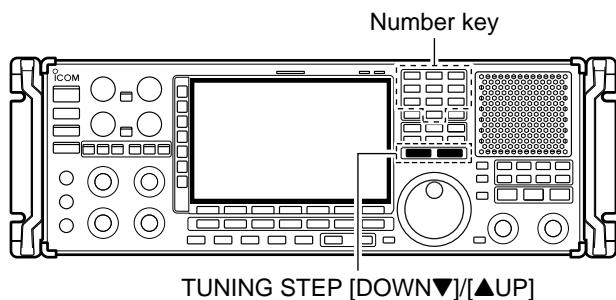

- ① Push the numeral keys on the keypad that correspond to the tuning step you wish to program.
 - Programmable tuning steps can be set between 0.1 and 999.9 kHz in 0.1 kHz steps.
 - ➡ To set programmable tuning steps, enter the desired steps via the keypad, then push [▲UP] or [▼DOWN].
- ② Push [▲UP] or [▼DOWN] to set the programmable tuning step.
 - Programmable tuning step is automatically selected as the active tuning step.

◇ Auto tuning step function

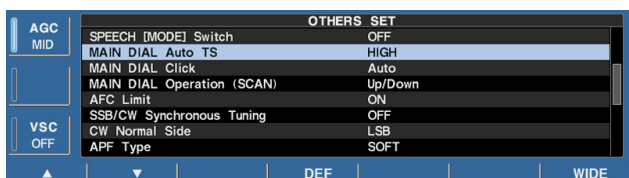
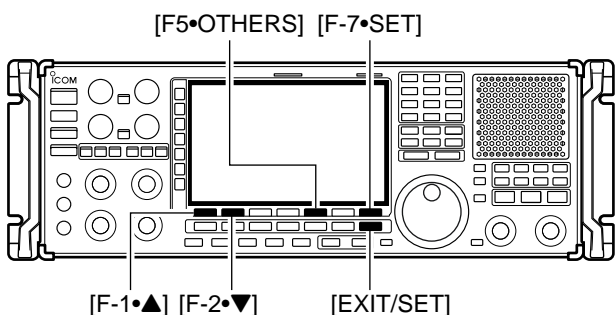

When rotating the main dial rapidly, the tuning speed accelerates automatically.

- ① Push [EXIT/SET] several times to close a multi-function screen, if necessary.
- ② Push [F-7•SET] to select set mode menu screen.
 - Pushing and holding [EXIT/SET] for 1 sec. also selects set mode menu screen.
- ③ Push [F-5•OTHERS] to enter the others set mode.
- ④ Push [F-1•▲] or [F-2•▼] to select "MAIN DIAL Auto TS."
- ⑤ Rotate main dial to select the desired condition from HIGH, LOW or OFF.
- ⑥ Push [EXIT/SET] to exit the set mode.
 - HIGH: Approx. 5 times faster
 - LOW: Approx. twice faster
 - OFF : Auto tuning step is turned OFF.

◇ 1/4 tuning step function

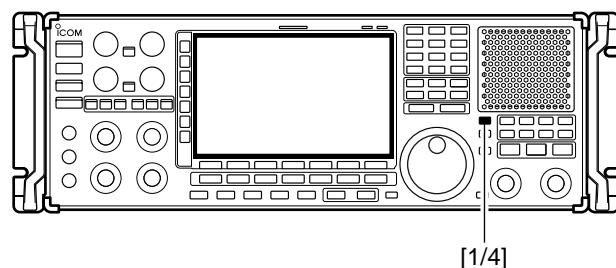

When operating in CW or FSK, the 1/4 tuning function is available. Dial rotation is reduced to 1/4 of normal speed when the 1/4 tuning function is ON for finer tuning control.

- ➡ Push [1/4] to toggle the 1/4 tuning function ON or OFF.
 - "1/4" appears when the 1/4 tuning function is ON.

Volume setting

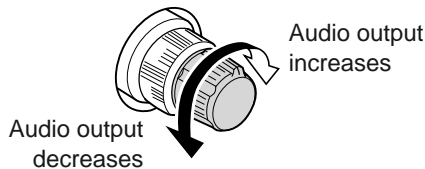
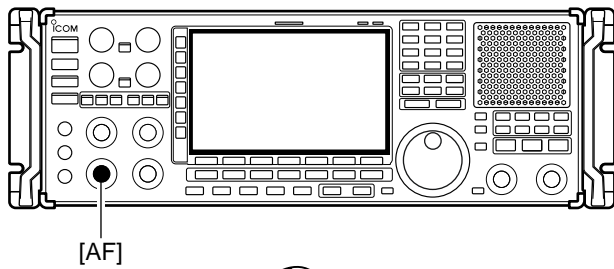

- Rotate [AF] control clockwise to increase, counterclockwise to decrease the audio output level.
- Set a suitable audio level.

RF gain adjustment

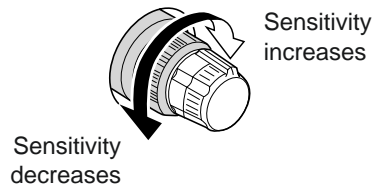
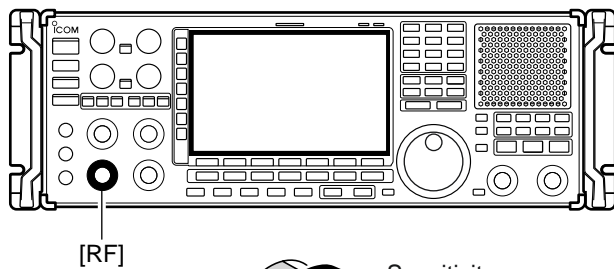

- Rotate [RF] control clockwise to increase, counterclockwise to decrease the receiver sensitivity.

NOTE:

- When [RF] control is adjusted CCW in FM mode, audio output decreases then disappears. This is normal, not a malfunction.
- When WFM mode is selected, RF gain is fixed MAX regardless of any [RF] control settings.

Squelch level adjustment

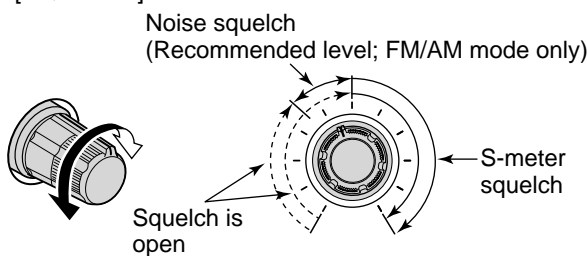
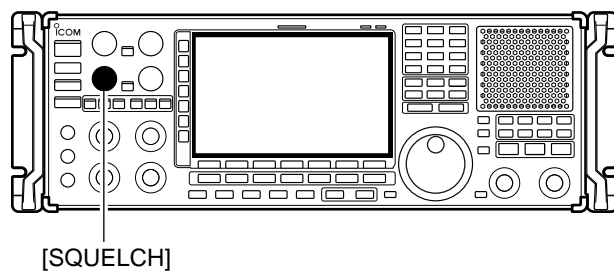

The squelch disables output from the speaker (closed position) when no signal is received.

- When no signal is received, rotate [SQUELCH] control fully counterclockwise first, then rotate [SQUELCH] clockwise to the point that the noise just disappears.
- Push and hold [MONI] to open the squelch temporarily.

■ Audio tone adjustment

NOTE: When [TREBLE] or [BASS] control is adjusted CCW, audio output decreases from [S/P DIF OUT], [ACC], [LINE OUT] or [REC OUT]. This is normal, not a malfunction.

◇ Treble level adjustment

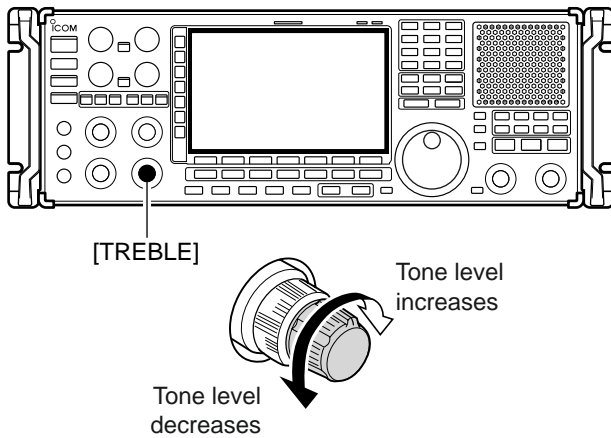

➤ Rotate [TREBLE] control clockwise to increase, counterclockwise to decrease the treble level of the audio tone.

◇ Bass level adjustment

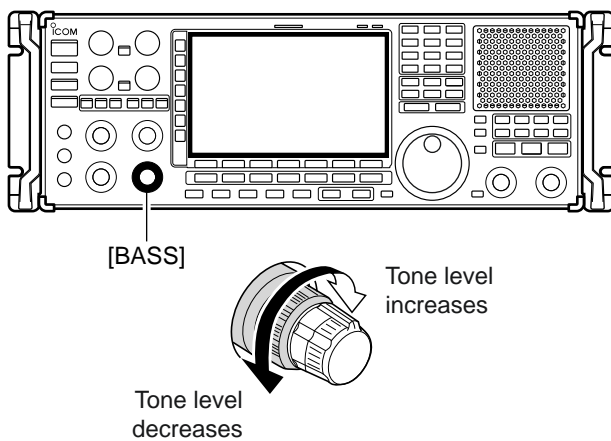

➤ Rotate [BASS] control clockwise to increase, counterclockwise to decrease the bass level of the audio tone.

Meter indication selection

Meter type selection

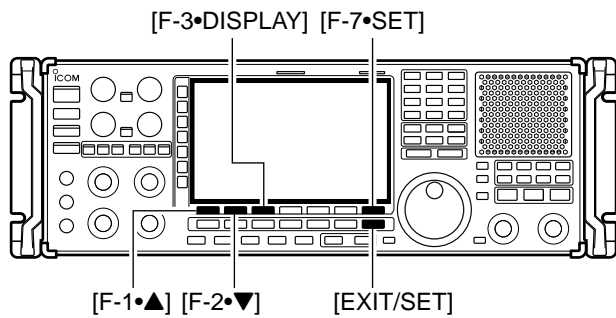

A total of 4 meter types are available in the IC-R9500— S-meter, $\text{dB}\mu$, $\text{dB}\mu(\text{EMF})$ and dBm meters. Follow the instructions below for the meter type selection.

- ① Push [EXIT/SET] several times to return to normal screen, if necessary.
- ② Push [F-7•SET], then push [F-3•DISPLAY] to select the display set mode.
- ③ Push [F-1•▲] or [F-2•▼] to select “Signal Meter” item.
- ④ Rotate main dial to select the desired meter type from “S,” “ $\text{dB}\mu$,” “ $\text{dB}\mu(\text{EMF})$ ” and “ dBm .”
- ⑤ Push [EXIT/SET] to exit the display set mode.

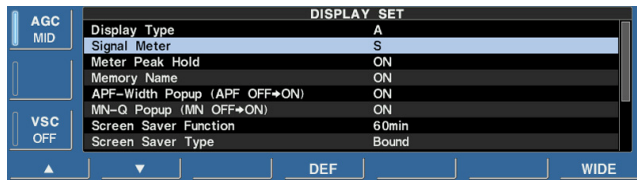

S meter



$\text{dB}\mu$ meter

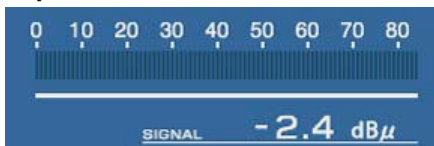

$\text{dB}\mu(\text{EMF})$ meter

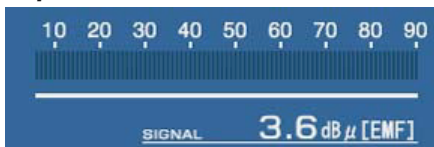

dBm meter

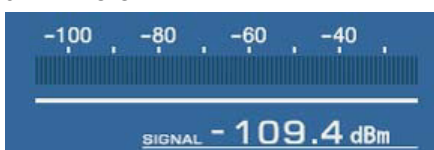

Signal meter squelch indicator

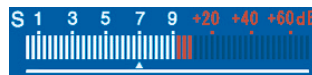

↑ Appears

“▲” indicates the signal meter squelch level and appears while [SQUELCH] control is rotating.

■ Operating FM	4-2
◇ Convenient functions for FM	4-2
■ Duplex operation	4-3
◇ Offset frequency setting	4-3
■ Tone/DTCS squelch operation	4-4
■ Operating WFM	4-5
◇ Convenient functions for WFM	4-5
■ Operating AM	4-6
◇ Convenient functions for AM	4-6
■ Operating SSB	4-7
◇ Convenient functions for SSB	4-7
■ Operating CW	4-8
◇ Convenient functions for CW	4-8
◇ APF (Audio Peak Filter) operation	4-9
◇ About CW reverse mode	4-9
◇ About CW pitch control	4-9
■ Operating FSK	4-10
◇ Convenient functions for FSK	4-11
◇ About FSK reverse mode	4-11
◇ Twin peak filter	4-11
◇ Setting FSK tone frequency	4-12
◇ Functions for the FSK decoder indication	4-13
◇ Setting the decoder threshold level	4-13
◇ FSK decode set mode	4-14
◇ Setting FSK Baud rate	4-16
◇ Time stamp function	4-16
◇ Data saving	4-17
■ Operating P25 (Requires optional UT-122)	4-18
◇ Convenient functions for P25	4-18
■ Digital squelch operation	4-19
■ TV channel operation (except for USA versions)	4-20
◇ Convenient functions for TV operation	4-20

■ Operating FM

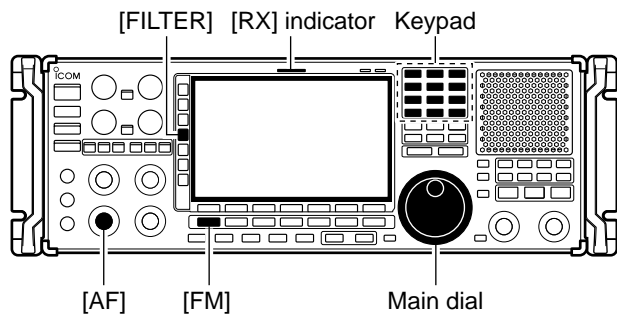

- ① Edit the desired frequency using the keypad.
- ② Push [FM] to select FM.
 - “ F M ” indicator appears.
- ③ Rotate the main dial to tune the desired frequency.
 - [RX] indicator lights green and the S-meter indicates received signal strength when signal is received.
 - 10 kHz tuning step is preset for the FM mode.
 - Push [FILTER] several times to select the desired filter width.
- ④ Rotate [AF] to set audio to a comfortable listening level.

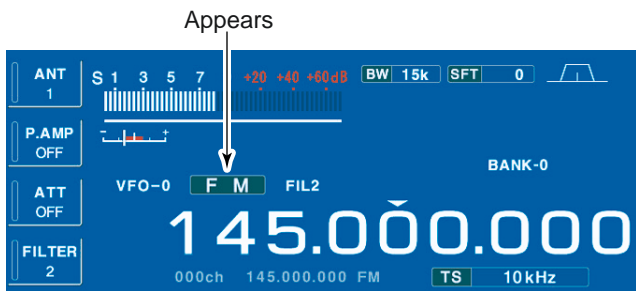

◇ Convenient functions for FM

- **Preamp** (p. 5-9)
 - ➔ Push [P.AMP] several times to set the preamp OFF, preamp 1 ON or preamp 2 ON. Only ON/OFF is available above 30 MHz.
 - “P.AMP1” or “P.AMP2” appears when the preamp 1 or preamp 2 is ON below 30 MHz. “P.AMP ON” appears above 30 MHz.
- **Attenuator** (p. 5-9)
 - ➔ Push [ATT] several times to set the attenuator in 6 dB steps for HF bands, or 10 dB step for 30–1150 MHz. Only 20 dB is available for 1150–3335 MHz.
 - “ATT” and attenuation level appear when the attenuator is ON.
- **Auto notch filter** (p. 5-16)
 - ➔ Push [ANF] switch to turn the auto notch function ON or OFF.
 - Notch indicator (above [ANF] switch) lights when either the auto notch is ON.
- **VSC (voice squelch control)** (p. 8-3)
 - ➔ Push [VSC] to turn the VSC function ON or OFF.
 - The VSC indicator appears when the voice squelch function is set to ON.
- **AFC (Auto Frequency Control)** (p. 5-17)
 - ➔ Push [AFC] to turn the AFC function ON or OFF.
 - The AFC indicator appears when the AFC function is set to ON.

■ Duplex operation

Duplex operation uses two different frequencies for transmitting and receiving. Generally, duplex is used in communication through a repeater, some utility communications, etc.

During repeater operation, the transmit station frequency is shifted from the receive station frequency by the offset frequency. Repeater information (offset frequency and shift direction) can be programmed into memory channels.

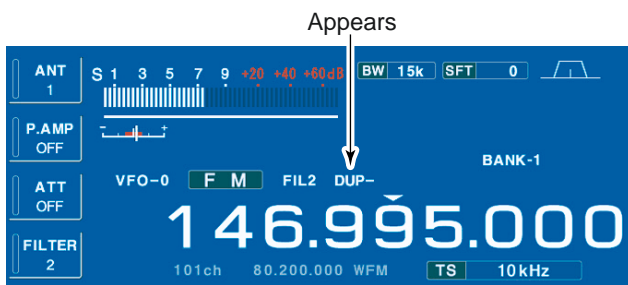
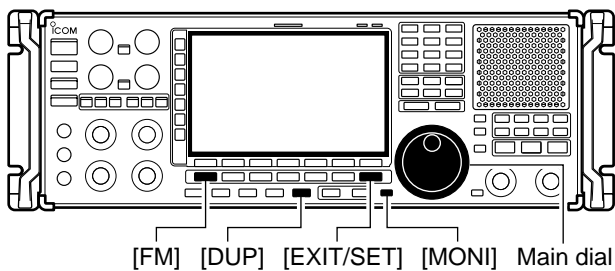

- ① Edit the desired receive frequency (repeater output frequency) using the keypad.
- ② Push [FM] to select FM.
 - “F M” indicator appears.
- ③ Push [DUP] several times to select the duplex direction.
 - “DUP-” or “DUP+” appears on the LCD.
- ④ Push and hold [DUP] for 1 sec. to enter the offset frequency setting screen, then rotate the main dial to set the desired offset frequency or edit the desired offset frequency directly with the keypad.
- ⑤ Push and hold [MONI] to monitor the transmit station frequency (repeater input frequency) directly.
- ⑥ To return to simplex, push [DUP] once or twice.

◇ Offset frequency setting

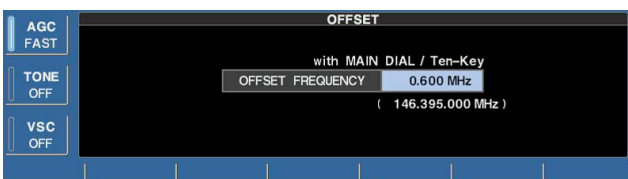
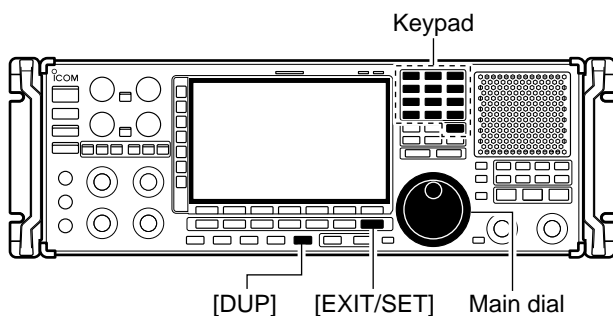

- ① Push and hold [DUP] for 1 sec. to enter offset frequency set mode.
- ② Rotate the main dial to select the desired offset frequency or edit the desired offset frequency directly with the keypad.
- ③ Push [EXIT/SET] to return to the previous indication.

■ Tone /DTCS squelch operation

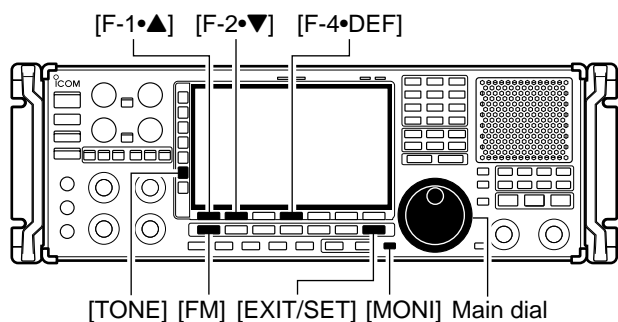

The tone or DTCS squelch opens only when receiving a signal containing a matching subaudible tone or DTCS code. You can silently wait for calls from group members using the same tone.

- ① Set the desired frequency and select FM mode.
- ② Push [TONE] several times to turn the tone or DTCS squelch function ON.
 - “**TSQL**” appears when the tone squelch function is ON.
 - “**DTCS**” appears when the DTCS squelch function is ON.
- ③ Push and hold [TONE] for 1 sec. to enter tone frequency set mode.
- ④ Push [F-1•▲] or [F-2•▼] to select the items, “T-SQL TONE” or “DTCS CODE.”
- ⑤ Rotate the main dial to select the desired tone frequency or DTCS code.
 - Push and hold [F-4•DEF] for 1 sec. to select the default setting.
- ⑥ Push [EXIT/SET] to return to the previous indication.
- ⑦ When the received signal includes a matching tone (or DTCS code), squelch opens and the signal can be heard.
 - When the received signal’s tone (or DTCS code) does not match, tone (DTCS) squelch does not open, however, the S-indicator shows signal strength.
- ⑧ To open the squelch manually, push [MONI].
 - The squelch opens temporarily while pushing and holding [MONI].
- ⑨ To cancel the tone squelch or DTCS squelch, push [TONE] several times to clear the tone or DTCS squelch.
 - “**TSQL**” or “**DTCS**” disappears.

• **Available tone frequencies** (unit: Hz)

67.0	85.4	107.2	136.5	165.5	186.2	210.7	254.1
69.3	88.5	110.9	141.3	167.9	189.9	218.1	150.0
71.9	91.5	114.8	146.2	171.3	192.8	225.7	
74.4	94.8	118.8	151.4	173.8	196.6	229.1	
77.0	97.4	123.0	156.7	177.3	199.5	233.6	
79.7	100.0	127.3	159.8	179.9	203.5	241.8	
82.5	103.5	131.8	162.2	183.5	206.5	250.3	

• **Available DTCS codes**

023	072	152	244	311	412	466	631
025	073	155	245	315	413	503	632
026	074	156	246	325	423	506	654
031	114	162	251	331	431	516	662
032	115	165	252	332	432	523	664
036	116	172	255	343	445	526	703
043	122	174	261	346	446	532	712
047	125	205	263	351	452	546	723
051	131	212	265	356	454	565	731
053	132	223	266	364	455	606	732
054	134	225	271	365	462	612	734
065	143	226	274	371	464	624	743
071	145	243	306	411	465	627	754

■ Operating WFM

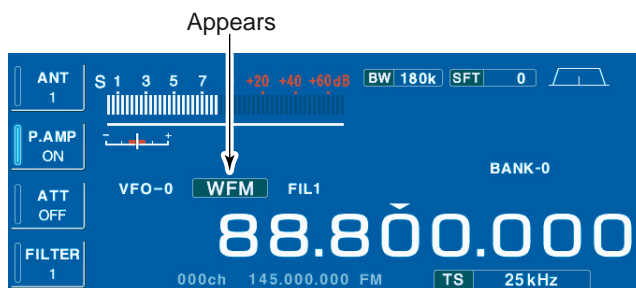
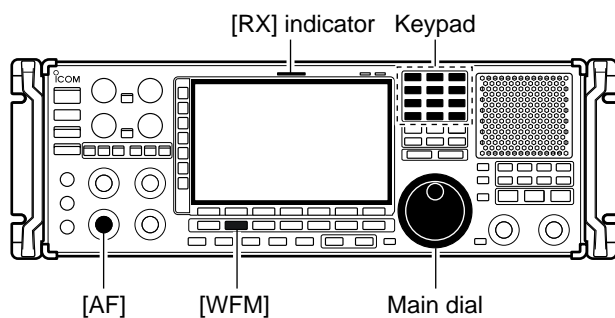

- ① Edit the desired frequency using the keypad.
- ② Push [WFM] to select WFM.
 - “WFM” indicator appears.
- ③ Rotate the main dial to tune the desired frequency.
 - [RX] indicator lights green and the S-meter indicates received signal strength when signal is received.
 - 25 kHz tuning step is preset for the WFM mode.
- ④ Rotate [AF] to set audio to a comfortable listening level.

◇ Convenient functions for WFM

- **Preamp** (p. 5-9)
 - Push [P.AMP] several times to set the preamp OFF, preamp 1 ON or preamp 2 ON. Only ON/OFF is available above 30 MHz.
 - “P.AMP1” or “P.AMP2” appears when the preamp 1 or preamp 2 is ON below 30 MHz. “P.AMP ON” appears above 30 MHz.
- **Attenuator** (p. 5-9)
 - Push [ATT] several times to set the attenuator in 6 dB steps for HF bands, or 10 dB step for 30–1150 MHz. Only 20 dB is available for 1150–3335 MHz.
 - “ATT” and attenuation level appear when the attenuator is ON.
- **Auto notch filter** (p. 5-16)
 - Push [ANF] switch to turn the auto notch function ON or OFF.
 - Notch indicator (above [ANF] switch) lights when either the auto notch is ON.
- **VSC (voice squelch control)** (p. 8-3)
 - Push [VSC] to turn the VSC function ON or OFF.
 - The VSC indicator appears when the voice squelch function is set to ON.
- **AFC (Auto Frequency Control)** (p. 5-17)
 - Push [AFC] to turn the AFC function ON or OFF.
 - The AFC indicator appears when the AFC function is set to ON.

■ Operating AM

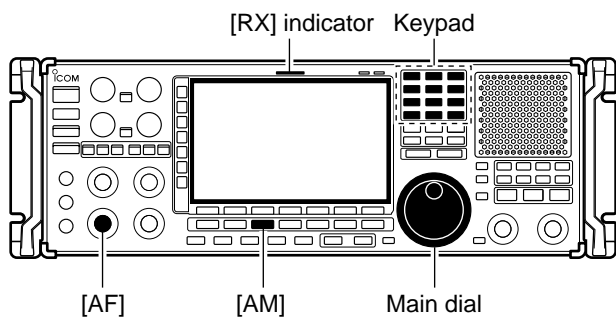

- ① Edit the desired frequency using the keypad.
- ② Push [AM] to select AM.
 - “A M” indicator appears.
 - After AM mode is selected, push and hold [AM] for 1 sec. to toggle between AM and S-AM modes.
- ③ Rotate the main dial to tune the desired frequency.
 - [RX] indicator lights green and the S-meter indicates received signal strength when signal is received.
- ④ Rotate [AF] to set audio to a comfortable listening level.

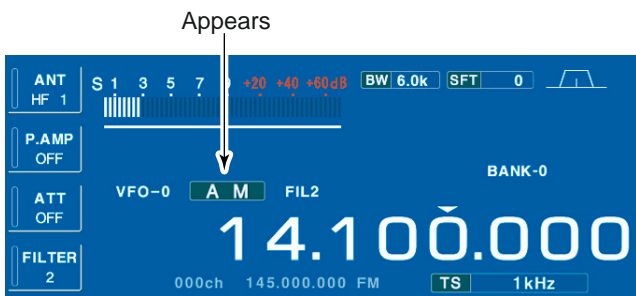

◇ Convenient functions for AM

- **Preamp** (p. 5-9)
 - ➔ Push [P.AMP] several times to set the preamp OFF, preamp 1 ON or preamp 2 ON. Only ON/OFF is available above 30 MHz.
 - “P.AMP1” or “P.AMP2” appears when the preamp 1 or preamp 2 is ON below 30 MHz. “P.AMP ON” appears above 30 MHz.
- **Attenuator** (p. 5-9)
 - ➔ Push [ATT] several times to set the attenuator in 6 dB steps for HF bands, or 10 dB step for 30–1150 MHz. Only 20 dB is available for 1150–3335 MHz.
 - “ATT” and attenuation level appear when the attenuator is ON.
- **Noise blanker** (p. 5-15)
 - ➔ Push [NB] switch to turn the noise blanker ON and OFF, and then rotate [NB] control to adjust the threshold level.
 - Noise blanker indicator (above [NB] switch) lights when the noise blanker is ON.
 - Push [NB] for 1 sec. to enter noise blanker set mode.
- **Noise reduction** (p. 5-16)
 - ➔ Push [NR] switch to turn the noise reduction ON and OFF.
 - Rotate [NR] control to adjust the noise reduction level.
 - Noise reduction indicator (above [NR] switch) lights when the noise reduction is ON.
- **Twin PBT (passband tuning)** (p. 5-11)
 - ➔ Rotate [TWIN PBT] controls (inner/outer).
 - Push [PBT CLEAR] to clear the settings.
- **Auto notch filter** (p. 5-16)
 - ➔ Push [ANF] switch to turn the auto notch function ON or OFF.
 - Notch indicator (above [ANF] switch) lights when the auto notch is ON.
- **Manual notch filter** (p. 5-16)
 - ➔ Push [NOTCH1] or [NOTCH2] switch to turn the manual notch function ON or OFF.
 - Rotate [NOTCH] control to set the notch frequency.
 - Notch indicator (above [NOTCH1] or [NOTCH2] switch) lights when either the manual notch is ON.
- **AGC (auto gain control)** (p. 5-10)
 - ➔ Push [AGC] switch several times to select AGC FAST, AGC MID or AGC SLOW.
 - ➔ Push [AGC VR] to turn the AGC time constant manual setting ON or OFF.
 - Rotate [AGC] control to adjust the time constant.
- **Auto tuning function** (p. 5-17)
 - ➔ Push [AUTOTUNE] to turn the auto tuning function ON or OFF.
 - The receiver automatically tunes the desired signal within ± 5 kHz range.

IMPORTANT!

When receiving a weak signal, or receiving a signal with interference, the automatic tuning function may not tune, or may tune to an undesired signal.

■ Operating SSB

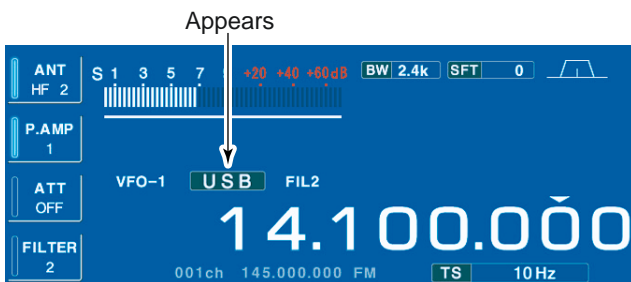
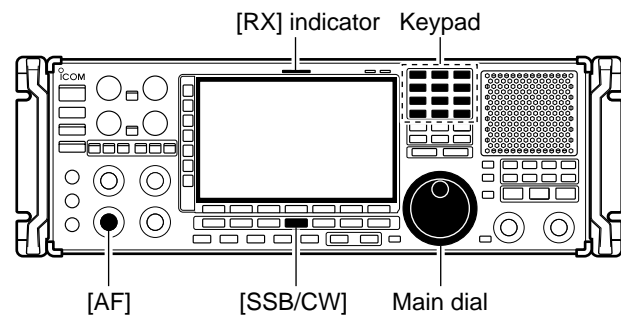

- ① Edit the desired frequency using the keypad.
- ② Push [SSB/CW] to select SSB.
 - USB is automatically selected.
 - After SSB mode is selected, push and hold [SSB/CW] for 1 sec. to toggle between USB and LSB modes.
 - “**USB**” or “**LSB**” appears.
- ③ Rotate the main dial to tune a desired signal.
 - [RX] indicator lights green and the S-meter indicates received signal strength when signal is received.
- ④ Rotate [AF] to set audio to a comfortable listening level.

◇ Convenient functions for SSB

- **Preamp** (p. 5-9)
 - ➔ Push [P.AMP] several times to set the preamp OFF, preamp 1 ON or preamp 2 ON. Only ON/OFF is available above 30 MHz.
 - “P.AMP1” or “P.AMP2” appears when the preamp 1 or preamp 2 is ON below 30 MHz. “P.AMP ON” appears above 30 MHz.
 - **Attenuator** (p. 5-9)
 - ➔ Push [ATT] several times to set the attenuator in 6 dB steps for HF bands, or 10 dB step for 30–1150 MHz. Only 20 dB is available for 1150–3335 MHz.
 - “ATT” and attenuation level appear when the attenuator is ON.
 - **Noise blanker** (p. 5-15)
 - ➔ Push [NB] switch several times to select the noise blanker 1 ON, noise blanker 2 ON and noise blanker OFF, and then rotate [NB] control to adjust the threshold level.
 - Noise blanker indicator (above [NB] switch) lights when the noise blanker is ON.
 - Push [NB] for 1 sec. to enter noise blanker set mode.
 - **Twin PBT (passband tuning)** (p. 5-11)
 - ➔ Rotate [TWIN PBT] controls.
 - Push [PBT CLEAR] to clear the settings.
 - **Noise reduction** (p. 5-16)
 - ➔ Push [NR] switch to turn the noise reduction ON and OFF.
 - Rotate [NR] control to adjust the noise reduction level.
 - Noise reduction indicator (above [NR] switch) lights when the noise reduction is ON.
 - **Auto notch filter** (p. 5-16)
 - ➔ Push [ANF] switch to turn the auto notch function ON or OFF.
 - Notch indicator (above [ANF] switch) lights when the auto notch is ON.
 - **Manual notch filter** (p. 5-16)
 - ➔ Push [NOTCH1] or [NOTCH2] switch to turn the manual notch function ON or OFF.
 - Rotate [NOTCH] control to set the attenuating frequency.
 - Notch indicator (above [NOTCH1] or [NOTCH2] switch) lights when either the manual notch is ON.
 - **AGC (auto gain control)** (p. 5-10)
 - ➔ Push [AGC] switch several times to select AGC FAST, AGC MID or AGC SLOW.
 - ➔ Push [AGC VR] to turn the AGC time constant manual setting ON or OFF.
 - Rotate [AGC] control to adjust the time constant.
 - **VSC (voice squelch control)** (p. 8-3)
 - ➔ Push [VSC] to turn the VSC function ON or OFF.
 - The VSC indicator appears when the voice squelch function is set to ON.
 - **Auto tuning function** (p. 5-17)
 - ➔ Push [AUTOTUNE] to turn the auto tuning function ON or OFF.
 - The receiver automatically tunes the desired signal within ± 1 kHz range.
- IMPORTANT!**
When receiving a weak signal, or receiving a signal with interference, the automatic tuning function may not tune, or may tune to an undesired signal.

■ Operating CW

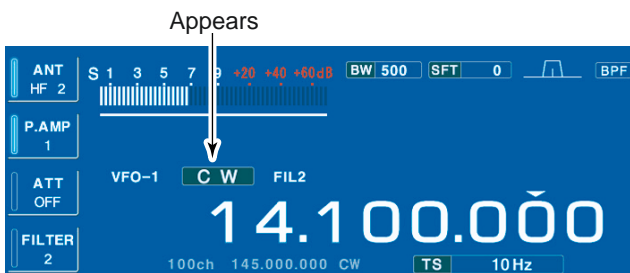
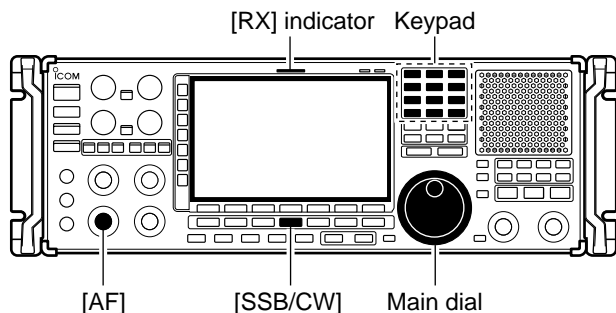

- ① Edit the desired frequency using the keypad.
- ② Push [SSB/CW] to select CW.
 - After CW mode is selected, push and hold [SSB/CW] for 1 sec. to toggle between CW and CW-R modes.
 - “**C W**” or “**CW-R**” appears.
- ③ Rotate the main dial to tune a desired signal.
 - Try to match the specified signal’s tone to the side tone frequency.
 - [RX] indicator lights green and the S-meter indicates received signal strength when signal is received.
- ④ Rotate [AF] to set audio to a comfortable listening level.

◇ Convenient functions for CW

- **Preamp** (p. 5-9)
 - ➔ Push [P.AMP] several times to set the preamp OFF, preamp 1 ON or preamp 2 ON. Only ON/OFF is available above 30 MHz.
 - “P.AMP1” or “P.AMP2” appears when the preamp 1 or preamp 2 is ON below 30 MHz. “P.AMP ON” appears above 30 MHz.
- **Attenuator** (p. 5-9)
 - ➔ Push [ATT] several times to set the attenuator in 6 dB steps for HF bands, or 10 dB step for 30–1150 MHz. Only 20 dB is available for 1150–3335 MHz.
 - “ATT” and attenuation level appear when the attenuator is ON.
- **Noise blanker** (p. 5-15)
 - ➔ Push [NB] switch to turn the noise blanker ON and OFF, and then rotate [NB] control to adjust the threshold level.
 - Noise blanker indicator (above [NB] switch) lights when the noise blanker is ON.
 - Push [NB] for 1 sec. to enter noise blanker set mode.
- **Noise reduction** (p. 5-16)
 - ➔ Push [NR] switch to turn the noise reduction ON and OFF.
 - Rotate [NR] control to adjust the noise reduction level.
 - Noise reduction indicator (above [NR] switch) lights when the noise reduction is ON.
- **Twin PBT (passband tuning)** (p. 5-11)
 - ➔ Rotate [TWIN PBT] controls (inner/outer).
 - Push [PBT CLEAR] to clear the settings.
- **Manual notch filter** (p. 5-16)
 - ➔ Push [NOTCH1] or [NOTCH2] switch to turn the manual notch function ON or OFF.
 - Rotate [NOTCH] control to set the notch frequency.
 - Notch indicator (above [NOTCH1] or [NOTCH2] switch) lights when either the manual notch is ON.
- **AGC (auto gain control)** (p. 5-10)
 - ➔ Push [AGC] switch several times to select AGC FAST, AGC MID or AGC SLOW.
 - ➔ Push [AGC VR] to turn the AGC time constant manual setting ON or OFF.
 - Rotate [AGC] control to adjust the time constant.
- **1/4 function** (p. 3-6)
 - ➔ Push [1/4] to turn the 1/4 function ON or OFF.
- **Auto tuning function** (p. 5-17)
 - ➔ Push [AUTOTUNE] to turn the auto tuning function ON or OFF.
 - The receiver automatically tunes the desired signal within a ±500 Hz range.
 - IMPORTANT!**
When receiving a weak signal, or receiving a signal with interference, the automatic tuning function may not tune properly, or tune onto an undesired signal.

◇ APF (Audio Peak Filter) operation

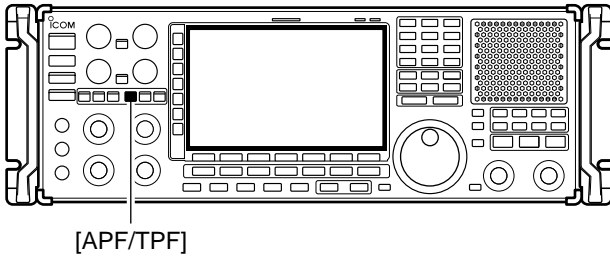

The APF changes the audio frequency response by boosting a particular frequency to enhance a desired CW signal.

The audio filter shape is also selectable from “SOFT” and “SHARP” in the others set mode. (p. 11-13)

- ① During CW mode, push [APF/TPF] to turn the audio peak filter ON and OFF.
 - “APF” appears in the display and [APF/TPF] indicator above this switch lights green.
- ② Push and hold [APF/TPF] for 1 sec. several times to select the desired audio filter width.
 - 320, 160 and 80 Hz filters are available.

◇ About CW reverse mode

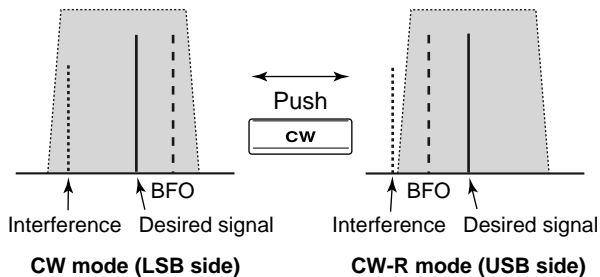

CW-R (CW Reverse) mode uses the opposite side band to receive CW signals.

Use when interfering signals are near a desired signal and you want to use CW-R to reduce the interference.

- ➔ During CW mode, push and hold [SSB/CW] for 1 sec. to select CW and CW-R mode.

◇ About CW pitch control

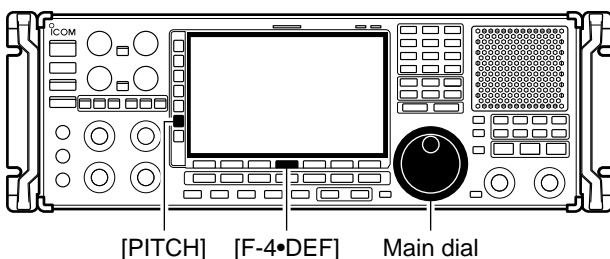

The received CW audio pitch can be adjusted to suit your preference (from 300 to 900 Hz in 5 Hz steps). This does not change the operating frequency.

- ① During CW mode, push [PITCH] to turn the CW pitch setting screen ON and OFF.
- ② Rotate the main dial to suit your preference.
 - Adjustable within 300 to 900 Hz in 5 Hz steps.
 - Push and hold [F-4•DEF] for 1 sec. to return to the default setting.



CW Pitch

800

Sets the desired CW pitch within 300 to 900 Hz in 5 Hz steps. (default: 800 Hz)

Operating FSK

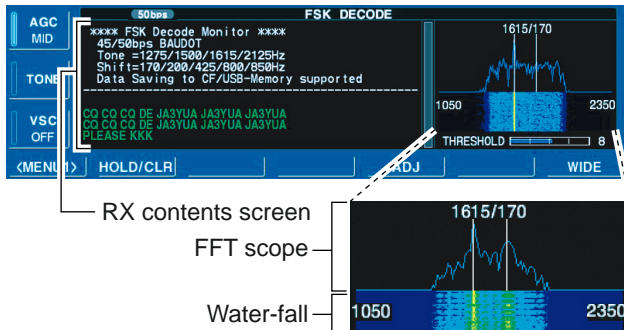
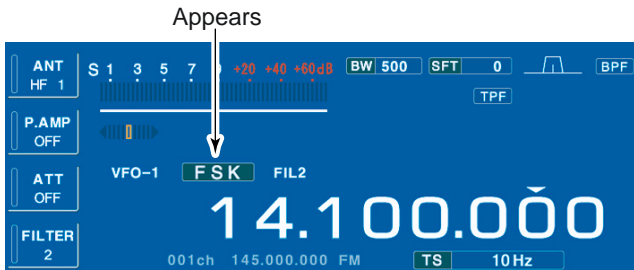
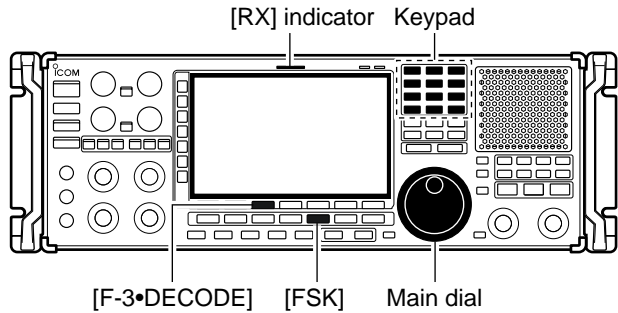

A DSP-based high-quality Baudot FSK decoder is built into the IC-R9500.

If you would rather use your FSK terminal or TNC, consult the manual that comes with the FSK terminal or TNC.

- ① Edit the desired frequency using the keypad.
- ② Push [FSK] to select FSK.
 - After FSK mode is selected, push and hold [FSK] for 1 sec. to toggle between FSK and FSK-R modes.
 - “**FSK**” or “**FSK-R**” appears.
- ③ Push [F-3•DECODE] to display the decoder screen.
 - The IC-R9500 has a built-in Baudot decoder.
- ④ To tune the desired signal, aim for a symmetrical wave form and ensure the signal peaks align with the mark and shift frequency lines in the FFT scope.
 - [RX] indicator lights green and the S-meter indicates received signal strength when signal is received.

◆ Convenient functions for FSK

- **Preamp** (p. 5-9)
 - ➔ Push [P.AMP] several times to set the preamp OFF, preamp 1 ON or preamp 2 ON. Only ON/OFF is available above 30 MHz.
 - “P.AMP1” or “P.AMP2” appears when the preamp 1 or preamp 2 is ON below 30 MHz. “P.AMP ON” appears above 30 MHz.
- **Attenuator** (p. 5-9)
 - ➔ Push [ATT] several times to set the attenuator in 6 dB steps for HF bands, or 10 dB step for 30–1150 MHz. Only 20 dB is available for 1150–3335 MHz.
 - “ATT” and attenuation level appear when the attenuator is ON.
- **Noise blanker** (p. 5-15)
 - ➔ Push [NB] switch to turn the noise blanker ON and OFF, and then rotate [NB] control to adjust the threshold level.
 - Noise blanker indicator (above [NB] switch) lights when the noise blanker is ON.
 - Push [NB] for 1 sec. to enter noise blanker set mode.
- **Twin PBT (passband tuning)** (p. 5-11)
 - ➔ Rotate [TWIN PBT] controls (inner/outer).
 - Push [PBT CLEAR] to clear the settings.
- **Noise reduction** (p. 5-16)
 - ➔ Push [NR] switch to turn the noise reduction ON and OFF.
 - Rotate [NR] control to adjust the noise reduction level.
 - Noise reduction indicator (above [NR] switch) lights when the noise reduction is ON.
- **Manual notch filter** (p. 5-16)
 - ➔ Push [NOTCH1] or [NOTCH2] switch to turn the manual notch function ON or OFF.
 - Rotate [NOTCH] control to set the notch frequency.
 - Notch indicator (above [NOTCH1] or [NOTCH2] switch) lights when either the manual notch is ON.
- **AGC (auto gain control)** (p. 5-10)
 - ➔ Push [AGC] switch several times to select AGC FAST, AGC MID or AGC SLOW.
 - ➔ Push [AGC VR] to turn the AGC time constant manual setting ON or OFF.
 - Rotate [AGC] control to adjust the time constant.
- **1/4 function** (p. 3-6)
 - ➔ Push [1/4] to turn the 1/4 function ON or OFF.

◆ About FSK reverse mode

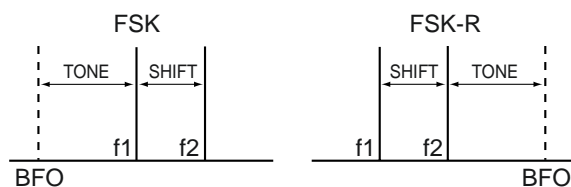

Received characters are occasionally garbled when the received signal has Mark and Space tones reversed. This reversal can be caused by incorrect TNC connections, setting, commands, etc. To receive reversed FSK signals correctly, select FSK-R mode.

- ➔ During FSK mode, push and hold [FSK] for 1 sec. to select FSK and FSK-R mode.

◆ Twin peak filter

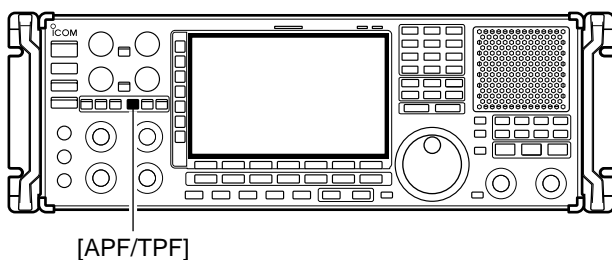

The twin peak filter changes audio frequency response by boosting the mark and space frequencies (2125 and 2295 Hz) for better reception of FSK signals.

- ➔ During FSK mode, push [APF/TPF] to turn the twin peak filter ON and OFF.
 - “TPF” appears in the LCD and the [APF/TPF] indicator above this switch lights green while the filter is in use.

NOTE: When the twin peak filter is in use, the received audio output may increase. This is normal, not a malfunction.

◇ Setting FSK tone frequency



Select the FSK tone frequency and adjust the FSK shift width.

- ① Select the FSK decoder screen as described on page 4-13.
- ② Push [TONE] on the multifunction menu to enter FSK tone set mode.
- ③ Push [F-1•▲] or [F-2•▼] to select the items, “FSK Tone Frequency” or “FSK Shift Width.”
- ④ Rotate the main dial to select the desired tone frequency or shift width.
 - Push and hold [F-4•DEF] for 1 sec. to select the default setting.
- ⑤ Push [EXIT/SET] to return to the previous indication.

FSK RX Frequency	Mark/Space Center
Selects the FSK receive frequency from Mark/Space Center and Mark(Space). (default: Mark/Space Center)	<ul style="list-style-type: none"> • Mark/Space Center: Displayed frequency is set to the center of Mark and Space. (①) • Mark(Space): Displayed frequency is set as higher frequency (f2). (②)
<p>The diagram illustrates the relationship between FSK and FSK-R frequencies. On the left, labeled 'FSK', a horizontal axis shows 'TONE' at frequency f_1 and 'SHIFT' at frequency f_2. On the right, labeled 'FSK-R', the axis shows 'SHIFT' at frequency f_1 and 'TONE' at frequency f_2. Both diagrams are centered around a 'BFO' (Beat Frequency Oscillator) reference point.</p>	

FSK Tone Frequency	1615
Selects the FSK mark frequency. FSK mark frequency is switched between 1275, 1615 and 2125 Hz. (default: 1615 Hz)	

FSK Shift Width	170
Selects the FSK shift width. There are 3 selectable values: 170, 200 and 425 Hz. (default: 170 Hz)	

◆ Functions for the FSK decoder indication

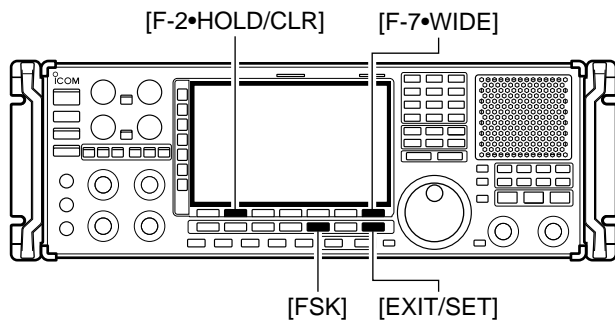

• Wide screen indication



◆ Setting the decoder threshold level



- ① Push [FSK] to select FSK.
 - After FSK mode is selected, push and hold [FSK] for 1 sec. to toggle between FSK and FSK-R modes.
 - “**FSK**” or “**FSK-R**” appears.
- ② Push [F-3•DECODE] to display the decoder screen.
 - When tuned into an FSK signal, decoded characters are displayed in the contents screen.
- ③ Push [F-2•HOLD/CLR] to freeze the current screen.
 - “**HOLD**” appears while the function is in use.
 - Push [F-2•HOLD/CLR] again to release the function.
- ④ Push and hold [F-2•HOLD/CLR] for 1 sec. to clear the displayed characters.
 - “**HOLD**” indicator disappears at the same time when the hold function is in use.
- ⑤ Push [F-7•WIDE] to toggle the FSK decode screen size from normal and wide.
- ⑥ Push [EXIT/SET] to close the FSK decode screen.

Adjust the FSK decoder threshold level if some characters are displayed when no signal is received.

- ① Select the FSK decoder screen as described above.
- ② Push [F-5•ADJ] to select the threshold level setting condition.
- ③ Rotate the main dial to adjust the FSK decoder threshold level.
 - Push and [F-6•DEF] for 1 sec. to select the default setting.
- ④ Push [F-5•ADJ] to exit from the threshold level setting condition.

▨ The UnShift On Space (USOS) function and new line code can be set in the FSK set mode. (p. 4-14)

◇ FSK decode set mode

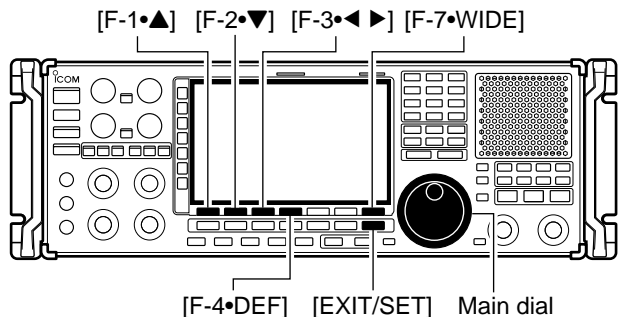

This set mode is used to set the decode USOS function, time stamp setting, etc.

• Setting contents

- ① During FSK mode operation, push [F-3•DECODE] to select FSK decode screen.
- ② Push [F-1•◀MENU1▶] to select FSK decode menu 2, then push [F-6•SET] to select FSK decode set mode.
 - Push [F-7•WIDE] to toggle the screen size from normal and wide.
- ③ Push [F-1•▲] or [F-2•▼] to select the desired set item.
- ④ Set the desired condition using the main dial.
 - Push and hold [F-4•DEF] for 1 sec. to select a default condition or value.
 - Push [F-3•◀▶] to select the set contents for some items.
- ⑤ Push [EXIT/SET] to exit from set mode.

• FSK decode set mode screen



FSK FFT Scope Averaging	OFF
Sets the FFT scope waveform averaging function from 2 to 4 and OFF. (default: OFF)	<p>Recommendation! If you use the FFT scope waveform for tuning, use of the default, or smaller number setting is recommended.</p>

FSK FFT Scope Waveform Color	
Sets the color for the FFT scope waveform. <ul style="list-style-type: none"> • The color is set in RGB format. • The set color is indicated in the box beside the RGB scale. 	<ul style="list-style-type: none"> • Push [F-3•◀▶] to select R (Red), G (Green) and B (Blue), and then rotate the main dial to set the ratio from 0 to 255.

FSK Decode USOS	ON
Turns letter code decoding after receiving a “space” (USOS; UnShift On Space function) capability ON and OFF.	<ul style="list-style-type: none"> • ON : Decode as letter code. • OFF : Decode as character code.

FSK Decode New Line Code	CR,LF,CR+LF
Selects the new line code of the internal FSK decoder. CR: Carriage Return, LF: Line Feed	<ul style="list-style-type: none"> • CR,LF,CR;LF : Makes new line with any codes. • CR+LF : Makes new line with CR+LF code only.

◇ FSK decode set mode (continued)

FSK Time Stamp (Time)	Local
<p>Selects the clock indication for time stamp usage.</p> <p>NOTE: The time will be displayed when [F-4•TIME] is pushed in “FSK DECODE” screen as at page 4-13.</p>	<ul style="list-style-type: none"> • Local : Selects the time that set in “Time (Now).” • UTC* : Selects the time that set in “CLOCK2.” <p>*The name of choice may differ according to “CLOCK2 Name” setting (p, 10-2). “UTC” is the default name of CLOCK2.</p>

FSK Time Stamp (Frequency)	ON
<p>Selects the operating frequency indication for time stamp usage.</p>	<ul style="list-style-type: none"> • ON : Displays the operating frequency. (default) • OFF : No operating frequency displays.

FSK Font Color (Receive)	
<p>Sets the text color for received characters.</p> <ul style="list-style-type: none"> • The color is set in RGB format. • The set color is indicated in the box beside the RGB scale. 	<ul style="list-style-type: none"> • Push [F-3•◀▶] to select R (Red), G (Green) and B (Blue), and then rotate the main dial to set the ratio from 0 to 255.

FSK Font Color (Time Stamp)	
<p>Sets the text color for time stamp indication.</p> <ul style="list-style-type: none"> • The color is set in RGB format. • The set color is indicated in the box beside the RGB scale. 	<ul style="list-style-type: none"> • Push [F-3•◀▶] to select R (Red), G (Green) and B (Blue), and then rotate the main dial to set the ratio from 0 to 255.

4 RECEIVE MODES

◇ Setting FSK baud rate

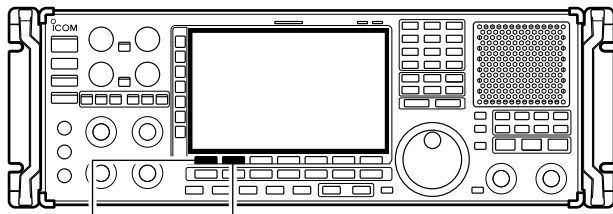

[F-1]•[MENU1] [F-2]•BAUD

50 bps Selected baud rate appears

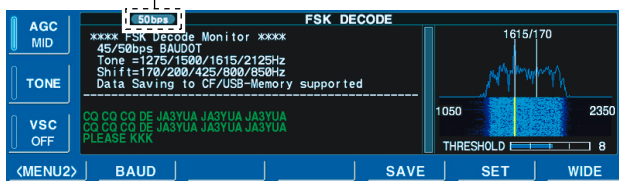

The data transfer rate can be selected from two speeds, 45 bps and 50 bps.

- ① Select the FSK decoder screen as described on page 4-13.
- ② Push [F-1]•[MENU1] to select the second FSK decode menu.
- ③ Push [F-2]•BAUD] to select the desired data transfer rate.
 - 45 bps and 50 bps are available.

◇ Time stamp function

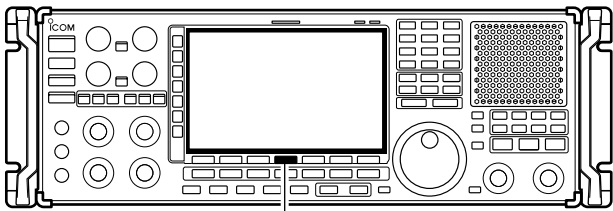

[F-4]•TIME

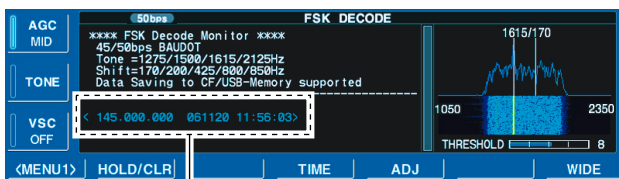

< 145.000.000 061120 11:56:03 >

Frequency Date Time

Time stamp function is used to add the time or frequency information when receiving a signal. Frequency information can be turned OFF in FSK decode set mode.

- ① Select the FSK decoder screen as described on page 4-13.
- ② Push [F-4]•TIME] to add the time stamp information.
 - Frequency , date and time information are added on the decoder screen.
- ③ Continue receiving.

◇ Data saving

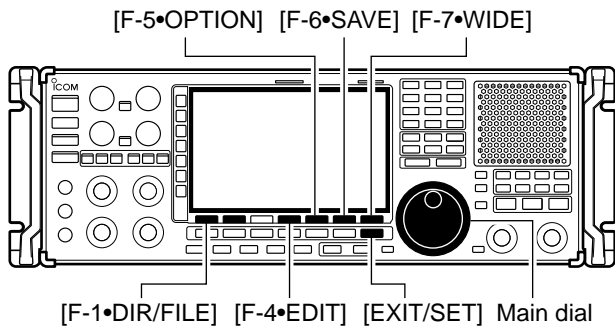

• Decode file save screen

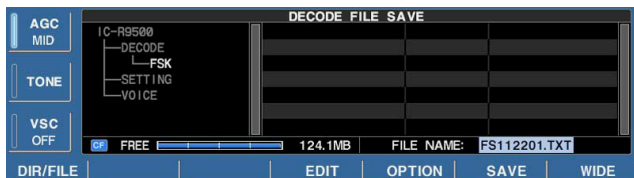

• Decode file save screen— file name edit

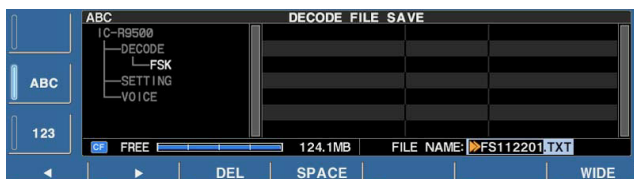

• Save option screen

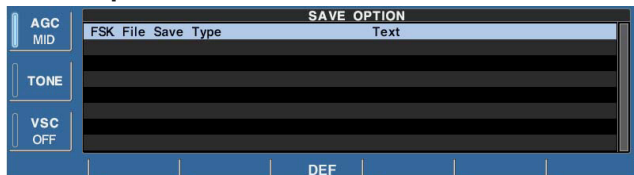

When USB-Memory is Inserted:

Push and hold [F-1•DIR/FILE] for 1 sec. to select the USB-Memory, or push and hold [F-1•DIR/FILE] for 1 sec. again to return to CF memory card when selecting the saving location.

The contents of the received signal can be saved in the CF memory card.

- ① In the FSK decode screen, push [F-1•<MENU1>] to select the second FSK decode menu.
- ② Push [F-5•SAVE] to select decode file save screen.
- ③ Change the following conditions if desired.

• File name:

- ① Push [F-4•EDIT] to select file name edit condition.
 - Push [F-1•DIR/FILE] several times to select the file name, if necessary.
- ② Push [ABC], [123] or [Symbol] to select the character group, then rotate the main dial to select the character.
 - Push [123] or [Symbol] to toggle numerals and symbols.
 - [ABC] : A to Z (capital letters); [123]: 0 to 9 (numerals); [Symbol]: ! # \$ % & ' ` ^ - () { } _ ~ @ can be selected.
 - Push [F-1•◀] to move the cursor left, push [F-2•▶] to move the cursor right, [F-3•DEL] delete a character and push [F-4•SPACE] to insert a space.
- ③ Push [EXIT/SET] to set the file name.

• File format

- ① Push [F-5•OPTION] to enter save option screen.
- ② Rotate the main dial to select the save format from Text or HTML.
 - “Text” is the default setting.
 - Push and hold [F-4•DEF] for 1 sec. to select the default setting.
- ③ Push [EXIT/SET] to return to the previous indication.

• Saving location

- ① Push [F-1•DIR/FILE] to select tree view screen.
- ② Select the desired directory or folder in the CF memory card.
 - Push [F-4•◀▶] to select the upper directory.
 - Push [F-2•▲] or [F-3•▼] to select folder in the same directory.
 - Push and hold [F-4•◀▶] for 1 sec. to select a folder in the directory.
 - Push [F-5•REN/DEL] to rename the folder.
 - Push and hold [F-5•REN/DEL] for 1 sec. to delete the folder.
 - Push and hold [F-6•MAKE] for 1 sec. to making a new folder. (Edit the name in the same manner as the “• File name” above.)
- ③ Push [F-1•DIR/FILE] twice to select the file name.

- ④ Push [F-6•SAVE].
 - After the save is completed, returns to FSK decode menu 2 automatically.

✓ For your convenience!

Two formats, Text and HTML, are available for storage of data to your PC.

■ Operating P25 (Requires optional UT-122)

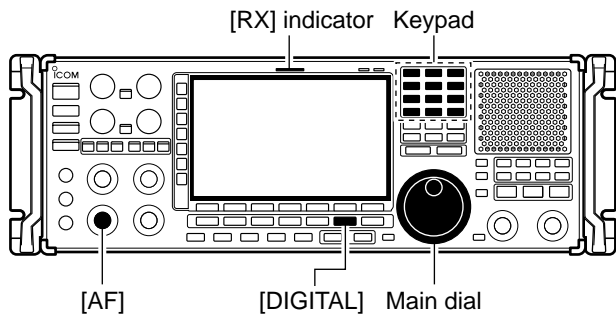

- ① Edit the desired frequency using the keypad.
- ② Push [DIGITAL] to select P25.
 - “ **P 2 5** ” indicator appears.
- ③ Rotate the main dial to tune the desired frequency.
 - [RX] indicator lights green and the S-meter indicates received signal strength when signal is received.
- ④ Rotate [AF] to set audio to a comfortable listening level.

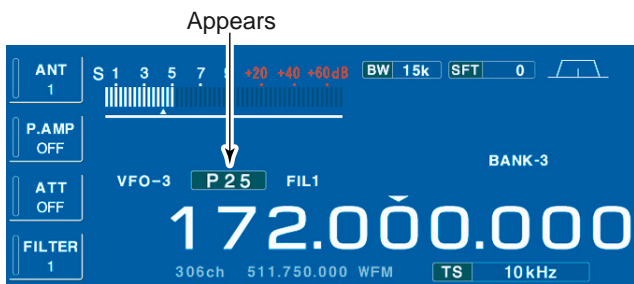

◇ Convenient functions for P25

- **Preamp** (p. 5-9)
 - Push [P.AMP] several times to set the preamp OFF, preamp 1 ON or preamp 2 ON. Only ON/OFF is available above 30 MHz.
 - “P.AMP1” or “P.AMP2” appears when the preamp 1 or preamp 2 is ON below 30 MHz. “P.AMP ON” appears above 30 MHz.
- **Attenuator** (p. 5-9)
 - Push [ATT] several times to set the attenuator in 6 dB steps for HF bands, or 10 dB step for 30–1150 MHz. Only 20 dB is available for 1150–3335 MHz.
 - “ATT” and attenuation level appear when the attenuator is ON.
- **Twin PBT (passband tuning)** (p. 5-11)
 - Rotate [TWIN PBT] controls (inner/outer).
 - Push [PBT CLEAR] to clear the settings.

■ Digital squelch operation

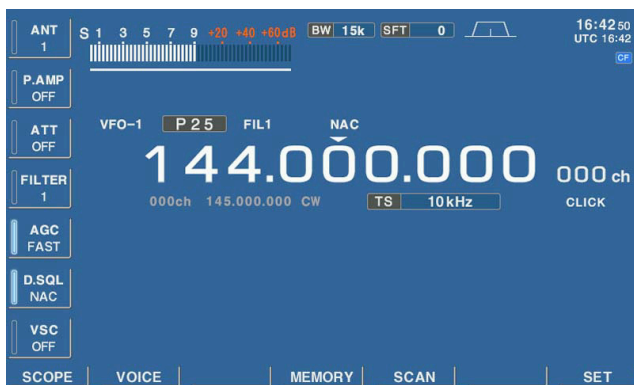
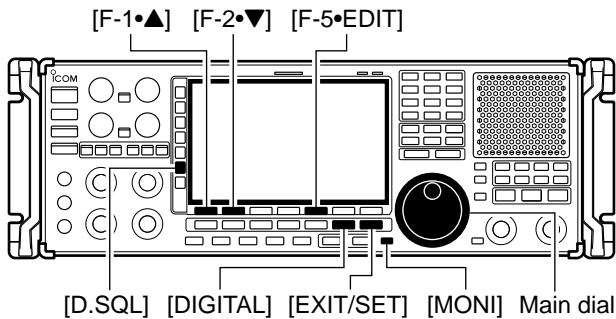

• Digital squelch set mode

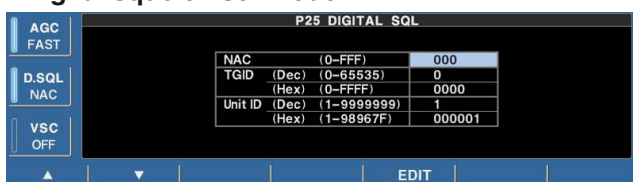

While in P25 mode operation, 2 types of digital squelch, NAC or Selective, are available.

- ① Set the desired frequency and select P25 mode.
- ② Push [D.SQL] to turn the digital squelch function ON.
 - “NAC” or “SEL” appears when the digital squelch function is ON.
- ③ Push and hold [D.SQL] for 1 sec. to enter P25 digital squelch set mode.
- ④ Push [F-1•▲] or [F-2•▼] to select the items, “NAC,” “TGID” or “Unit ID.”
- ⑤ Push [F-5•EDIT] to enter digital code programming.
 - A cursor appears and blinks.
 - Push [F-1•◀] or [F-2•▶] for cursor movement.
 - Push [F-3•DEL] to delete the selected code.
 - Using the receiver’s keypad, [0]–[9], can also enter numerals.
 - Multifunction switch guide changes to the additional keys, [A]–[F], for hexadecimal input.
- ⑥ Push [F-5•SET] to input and set the code.
 - The cursor disappears.
- ⑦ Push [EXIT/SET] to return to the previous indication.
- ⑧ When the received signal includes a matching code, squelch opens and the signal can be heard.
 - When the received signal’s code does not match, digital squelch does not open, however, the S-indicator shows signal strength.
- ⑨ To open the digital squelch manually, push [MONI].
 - The digital squelch opens temporarily while pushing and holding [MONI].
- ⑩ To cancel digital squelch, push [D.SQL] several times to clear the digital squelch.
 - “NAC” or “SEL” disappears.

■ TV channel operation (except for USA versions)

A TV tuner is built-in to the IC-R9500, and connects to the [VIDEO IN] and [VIDEO OUT] on the rear panel using a TV jumper cable to monitor the TV programs (except for USA version).

If you would rather use your TV tuner, connect the external tuner to [VIDEO IN] on the rear panel.

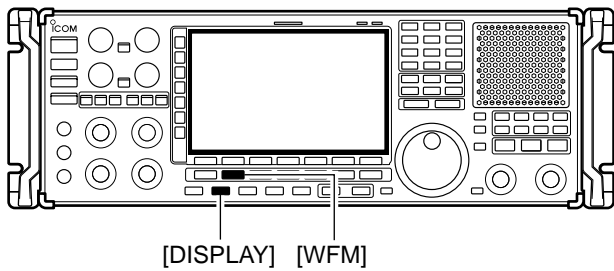

- ① Push [DISPLAY] once or twice to turn ON the desired video screen.
 - Push once to turn ON the mini video screen, push again to turn ON the full video screen and push again to close the video screen.
- ② Set the desired frequency and select WFM mode.
 - If you connect the external tuner, this setting is not necessary.
- ③ Push [DISPLAY] to close the video screen.

▨ The video display settings can be adjusted in display set (Video) mode. (p. 11-24)



◇ Convenient functions for TV operation

- **Preamp** (p. 5-9)
 - ➔ Push [P.AMP] several times to set the preamp OFF, preamp 1 ON or preamp 2 ON. Only ON/OFF is available above 30 MHz.
 - “P.AMP1” or “P.AMP2” appears when the preamp 1 or preamp 2 is ON below 30 MHz. “P.AMP ON” appears above 30 MHz.
- **Attenuator** (p. 5-9)
 - ➔ Push [ATT] several times to set the attenuator in 6 dB steps for HF bands, or 10 dB step for 30–1150 MHz. Only 20 dB is available for 1150–3335 MHz.
 - “ATT” and attenuation level appear when the attenuator is ON.
- **Auto notch filter** (p. 5-16)
 - ➔ Push [ANF] switch to turn the auto notch function ON or OFF.
 - Notch indicator (above [ANF] switch) lights when either the auto notch is ON.
- **VSC (voice squelch control)** (p. 8-3)
 - ➔ Push [VSC] to turn the VSC function ON or OFF.
 - The VSC indicator appears when the voice squelch function is set to ON.
- **AFC (Auto Frequency Control)** (p. 5-17)
 - ➔ Push [AFC] to turn the AFC function ON or OFF.
 - The AFC indicator appears when the AFC function is set to ON.

■ Spectrum scope screen	5-2
◇ Center mode	5-2
◇ Fix mode	5-3
◇ Peak marker function	5-4
◇ Wide band-pass filter selection	5-5
◇ Wide band scope function	5-5
◇ Mini scope screen indication	5-6
◇ Scope set mode	5-6
■ Preamplifier	5-9
■ Attenuator	5-9
■ AGC function	5-10
◇ Selecting the preset value	5-10
◇ Adjusting the AGC time constant	5-10
◇ Setting the AGC time constant preset value	5-10
■ Twin PBT operation	5-11
■ IF filter selection	5-12
◇ IF filter selection	5-12
◇ Filter passband width setting	5-12
◇ Roofing filter selection	5-13
◇ DSP filter shape	5-13
◇ Filter shape set mode	5-13
■ Noise blanker	5-15
◇ NB set mode	5-15
■ Noise reduction	5-16
■ Notch function	5-16
■ Autotune function	5-17
■ AFC function	5-17

■ Spectrum scope screen

◇ Center mode

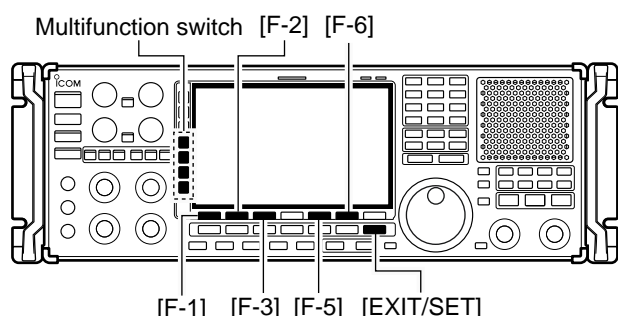

MENU1	SPAN	BW/SPEED	ATT	HOLD	CENT/FIX	PEAK
MENU2	W-BPF					SET
[F-1]	[F-2]	[F-3]	[F-4]	[F-5]	[F-6]	[F-7]

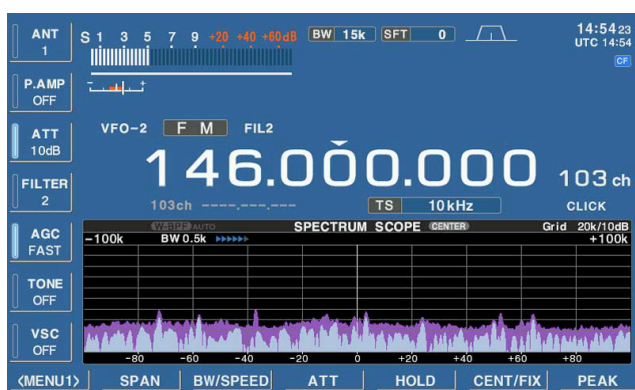

• Observed indication example

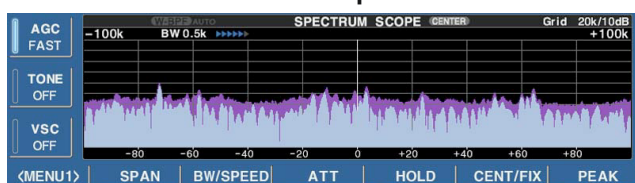

This DSP-based spectrum scope allows you to display the conditions on the selected band, as well as relative strengths of signals. The IC-R9500 has two modes for the spectrum indication— one is center mode, and another one is fixed mode.

In addition, the IC-R9500 has a mini-scope screen to save screen space.

Displays signals around the set frequency within the selected span. The set frequency is always displayed at the center of the screen.

- ① Push [EXIT/SET] several times to close a multi-function screen, if necessary.
- ② Push [F-1•SCOPE] to select the scope screen.
 - The spectrum scope shows the peak level holding function. Peak levels are displayed in the background of the current spectrum in a different color until the receive frequency changes. This can be deactivated and the waveform color can be set in scope set mode. (p. 5-7)
- ③ Push [F-6•CENT/FIX] to select the center mode.
 - “**CENTER**” is displayed when center mode is selected.
- ④ Push [F-2•SPAN] once.
 - Multifunction switch guide changes to the span setting guide.
- ⑤ Push [SPAN+] or [SPAN–] several times to select the scope span.
 - ±2.5 k, ±5.0 k, ±10 k, ±25 k, ±50 k, ±100 k, ±250 k, ±500 k, ±1 M, ±2.5 M and ±5 MHz are available.
- ⑥ Push [F-3•BW/SPEED] once.
 - Multifunction switch guide changes to the resolution band width/speed setting guide.
- ⑦ Push [BW+] or [BW–] several times to select the resolution band width.
 - 0.2 k, 0.5 k, 1 k, 2 k, 5 k, 10 k and 20 kHz are available.
- ⑧ Push [SPEED–] or [SPEED+] several times to select the sweep speed.
- ⑨ Push [F-4•ATT] several times to activate an attenuator or turn the attenuator OFF.
 - 10, 20 and 30 dB attenuators are available.
- ⑩ Push [F-5•HOLD] to freeze the current spectrum waveform.
 - “**HOLD**” appears while the function is in use.
 - The peak hold function can be deactivated in scope set mode.
- ⑪ Push [EXIT/SET] to exit the scope screen.

NOTE: If a strong signal is received, a ghost waveform may appear. Push [F-4•ATT] several times to activate the spectrum scope attenuator in this case. Spurious signal waveforms may be displayed if generated in the internal scope circuit and do not indicate a receiver malfunction.

◇ Fixed frequency mode

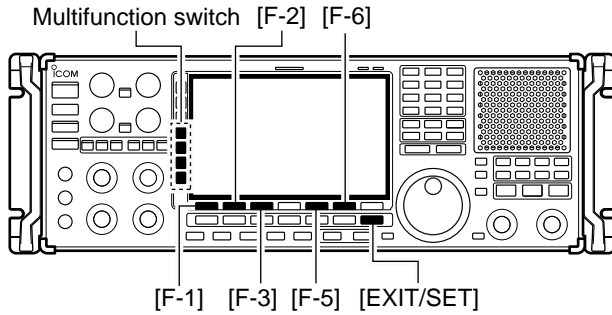

MENU1	EDGE	BW/SPEED	ATT	HOLD	CENT/FIX	PEAK
MENU2	W-BPF					SET
[F-1]	[F-2]	[F-3]	[F-4]	[F-5]	[F-6]	[F-7]

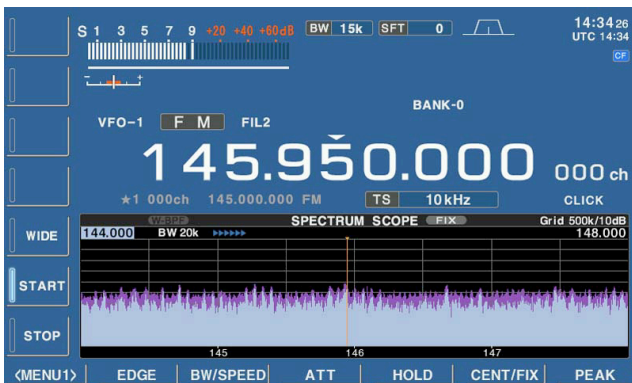

Displays signals within the specified frequency range. The selected frequency band conditions can be observed at a glance when using this mode.

- ① Push [EXIT/SET] several times to close a multi-function screen, if necessary.
- ② Push [F-1•SCOPE] to select the scope screen.
 - The spectrum scope shows the peak level holding function. Peak levels are displayed in the background of the current spectrum in a different color until the receive frequency changes. This can be deactivated and the waveform color can be set in scope set mode. (p. 5-7)
- ③ Push [F-6•CENT/FIX] to select the fixed mode.
 - “**FIX**” is displayed when fix mode is selected.
- ④ Push [F-2•EDGE] once.
 - Multifunction switch guide changes to the resolution band width/speed setting guide.
- ⑤ Push [START] then edit the desired frequency using the keypad to set the lower frequency edge, and push [STOP] then edit the desired frequency using the keypad to set the higher frequency edge.
- ⑥ Push [F-3•BW/SPEED] once.
 - Multifunction switch guide changes to the resolution band width/speed setting guide.
- ⑦ Push [BW+] or [BW-] several times to select the resolution band width.
 - 0.2 k, 0.5 k, 1 k, 2 k, 5 k, 10 k and 20 kHz are available depends on the frequency range.
- ⑧ Push [SPEED-] or [SPEED+] several times to select the sweeping speed.
- ⑨ Push [F-4•ATT] several times to activate an attenuator or turn the attenuator OFF.
 - 10, 20 and 30 dB attenuators are available.
- ⑩ Push [F-5•HOLD] to freeze the current spectrum waveform.
 - “**HOLD**” appears while the function is in use.
 - The peak hold function can be deactivated in scope set mode.
- ⑪ Push [EXIT/SET] to exit the scope screen.

/// **NOTE:** If a strong signal is received, a ghost waveform may appear. Push [F-4•ATT] several times to activate the spectrum scope attenuator in this case.

◇ Peak marker function

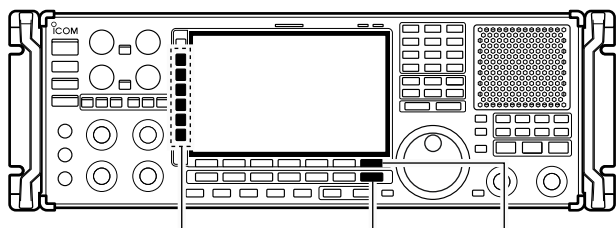

Multifunction switch [EXIT/SET] [F-7] PEAK

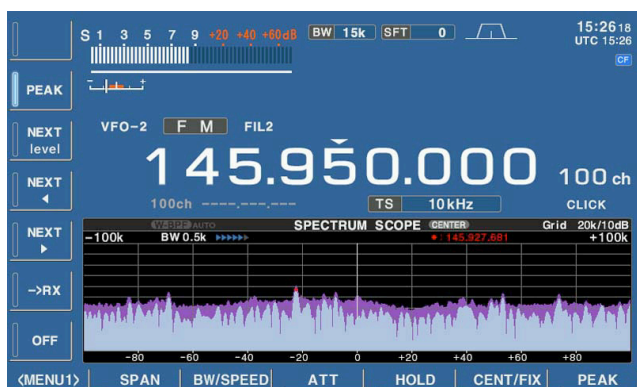

The peak marker function can display the frequencies of several peaks in order.

- ① Push [EXIT/SET] several times to close a multi-function screen, if necessary.
- ② Push [F-1•SCOPE] to select the scope screen.
 - The spectrum scope shows the peak level holding function. Peak levels are displayed in the background of the current spectrum in a different color until the receive frequency changes. This can be deactivated and the waveform color can be set in scope set mode. (p. 5-7)
- ③ Push [F-6•CENT/FIX] to select center or fixed mode.
- ④ Push [F-7•PEAK] once.
 - Multifunction switch guide changes to the peak selection guide.
- ⑤ Push [PEAK] to place the marker on the first peak.
 - Push [NEXT level] to search for the next peak level.
 - Push [NEXT ◀] to search for the next peak level of lower frequency.
 - Push [NEXT ▶] to search for the next peak level of higher frequency.
 - Push and hold [→RX] to overwrite the peak level frequency as the new center frequency.
 - Push [OFF] to turn OFF the maker.
 - “<<” or “>>” appears when the marker is out of range.
- ⑥ Push [EXIT/SET] to return to the previous screen.

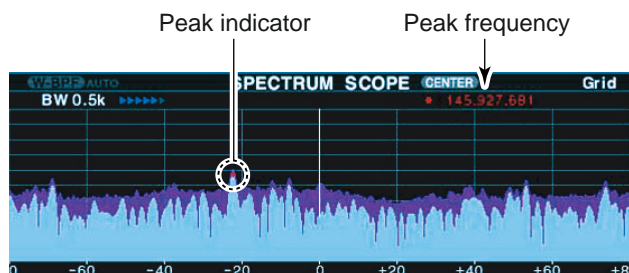

◇ Wide band-pass filter selection

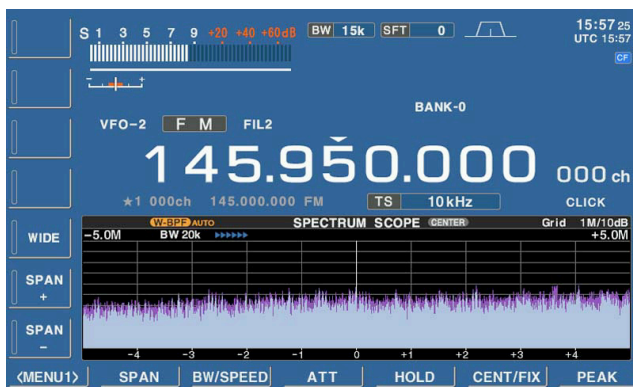
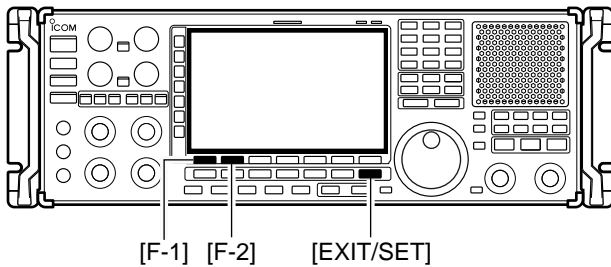

The wide band-pass filter function can change the RF band pass filter and the select the wide band-pass filter

- ① During spectrum scope display ON, push [F-1]•[MENU1] to select the second scope menu.
- ② Push [F-2]•W-BPF once or twice to select the wide band-pass filter setting ON, AUTO or OFF.
 - “W-BPF” appears when ON is selected, “W-BPF AUTO” appears when AUTO is selected or no indication appears when OFF is selected.
 - While W-BPF AUTO is activate, the wide band pass filter is automatically selected when wider than 500 kHz span is selected.
- ③ Push [EXIT/SET] to return to the previous screen.

NOTE: The RF filter circuit is commonly used for the scope signal and received signal. When W-BPF is selected, or W-BPF AUTO is selected with wider than 500 kHz span, interference may heard due to the received signal passing through the high pass filter instead of the specified band-pass filters.

◇ Wide band scope function

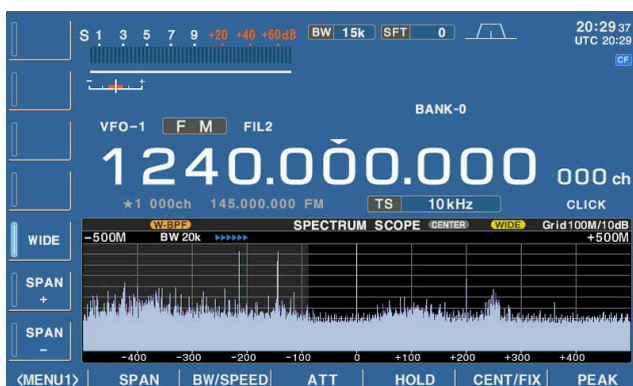
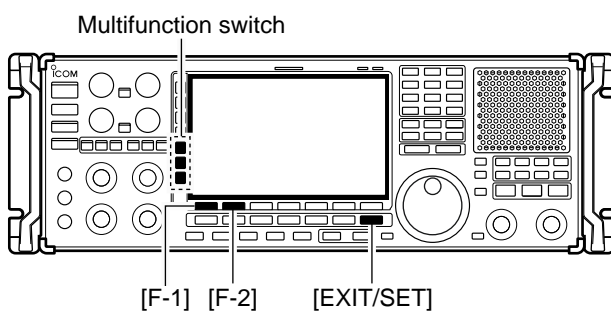

The wide band scope function is available to sweep a wide frequency range (max. ± 500 MHz). While this function is active, AF monitor is not available.

- ① During spectrum scope display ON, push [F-2]•SPAN to select the span setting condition.
 - Multifunction switch guide changes to the span selection guide.
- ② Push [WIDE] to select the wide band scope function ON or OFF.
 - When ON is selected, audio disappears.
- ③ Push [SPAN+] or [SPAN-] several times to select the scope span.
 - ± 5.0 M, ± 10 M, ± 25 M, ± 50 M, ± 100 M, ± 250 M and ± 500 M are available.
- ④ Push [EXIT/SET] to return to the previous screen.

◇ Mini scope screen indication

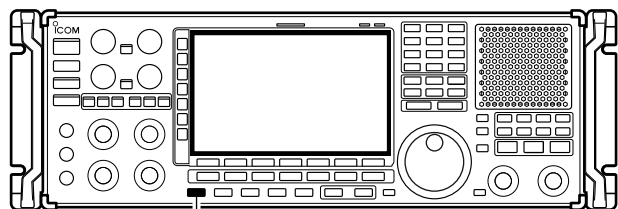

[M.SCOPE]

The mini scope screen can be displayed with another screen display, such as set mode menu, decoder screen, memory list screen, etc. simultaneously.

- ① Set the scope mode (center or fixed), marker, attenuator, span, etc. in advance. (pgs. 5-2, 5-3)
- ② Push [M.SCOPE] to toggle the mini scope indication ON and OFF.



◇ Scope set mode

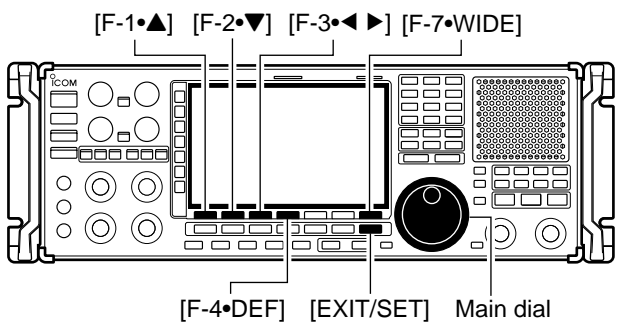

This set mode is used to set the waveform color, center frequency indication for center mode, etc.

- ① During spectrum scope display ON, push [F-1•◀MENU1] to select the second scope menu.
- ② Push [F-7•SET] to enter scope set mode screen.
 - Push [F-7•WIDE] to toggle the screen size between normal and wide.
- ③ Push [F-1•▲] or [F-2•▼] to select the desired set item.
- ④ Set the desired condition using the main dial.
 - Push and hold [F-4•DEF] for 1 sec. to select the default condition or value.
 - Push [F-3•◀▶] to select the set contents for some items.
- ⑤ Push [EXIT/SET] to exit from set mode.



◇ Scope set mode (continued)

Max Hold**ON**

Turn the peak level holding function ON or OFF.

CENTER Type Display**Filter Center**

Select the center frequency of the spectrum scope indication (center mode only).

- Filter center : Shows the selected filter's center frequency at the center.
- Carrier Point Center : Shows the selected operating mode carrier point frequency at the center.
- Carrier Point Center (Abs. Freq.) : In addition to the carrier point center setting above, the actual frequency is displayed at the bottom of the scope.

Waveform Color (Current)

A horizontal bar with three color swatches: red, green, and blue. Each swatch has a numerical value next to it: 161 (red), 185 (green), and 221 (blue).

Set the waveform color for the currently received signals.

- The color is set in RGB format.
- Push [F-3•◀▶] to select R (Red), G (Green) and B (Blue), and rotate the ratio from 0 to 255 range.
- The set color is indicated in the box beside the RGB scale.

Waveform Color (Max Hold)

A horizontal bar with three color swatches: purple, green, and blue. Each swatch has a numerical value next to it: 130 (purple), 66 (green), and 176 (blue).

Set the waveform color for the receiving signals maximum level.

- The color is set in RGB format.
- Push [F-3•◀▶] to select R (Red), G (Green) and B (Blue), and rotate the ratio from 0 to 255 range.
- The set color is indicated in the box beside the RGB scale.

Marker Color (RX)

A horizontal bar with three color swatches: orange, green, and blue. Each swatch has a numerical value next to it: 255 (orange), 150 (green), and 50 (blue).

Set the marker color for the displayed frequency while the fix mode.

- The color is set in RGB format.
- Push [F-3•◀▶] to select R (Red), G (Green) and B (Blue), and rotate the ratio from 0 to 255 range.
- The set color is indicated in the box beside the RGB scale.

Marker Color (Peak)

A horizontal bar with three color swatches: red, black, and black. Each swatch has a numerical value next to it: 255 (red), 0 (black), and 0 (black).

Set the marker color for the peak frequency of the receiving signals.

- The color is set in RGB format.
- Push [F-3•◀▶] to select R (Red), G (Green) and B (Blue), and rotate the ratio from 0 to 255 range.
- The set color is indicated in the box beside the RGB scale.

◇ Scope set mode (continued)**Peak Excursion****6dB**

Set the next peak excursion level from 0 to 80 dB in 1 dB steps. (default: 6 dB)

If the difference between the signal peak and adjacent minimum values is less than the set level, it will not be found as the next peak level when [NEXT◀] or [NEXT▶] is pushed.

Peak Threshold**-90dB**

Set the next peak threshold level from 0 to -100 dB in 1 dB steps. (default: -90dB)

If the difference between the signal and last peak signal values is more than the set level, it will not be found as the next peak level when [NEXT◀] or [NEXT▶] is pushed.

■ Preamplifier

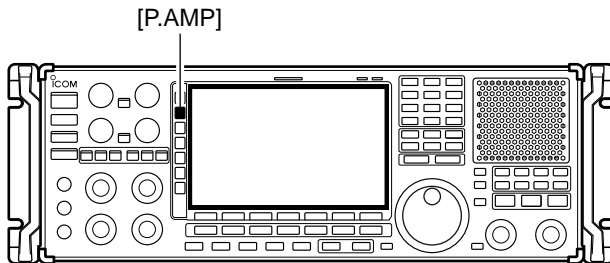

During 1150–3335 MHz (ANT2) operation, either the preamplifier or attenuator is activate exclusively.

The preamp amplifies received signals in the receiver front end, to improve the S/N ratio and sensitivity. Set this to preamp 1 or preamp 2 when receiving weak signals.

➔ Push [P.AMP] several times to set the preamp OFF, preamp 1 ON or preamp 2 ON.

• Below 30 MHz

P.AMP 1 For all HF bands

P.AMP 2 For all HF bands

• Above 30 MHz

P.AMP ON Only ON/OFF is available

✓ About the “P.AMP2”

The “P.AMP 2” is a high gain receive amplifier. When the “P.AMP 2” is used when strong signal are present, distortion sometimes results. If this occurs, use the receiver with the “P.AMP 1” or “P.AMP OFF” setting.

The “P.AMP 2” is most effective when:

- Used on bands above 24 MHz and when signals are weak.
- Receive sensitivity is insufficient during low gain, or while using a narrow band antenna (such as small loop, a Beverage antenna or a short Yagi antenna).

■ Attenuator

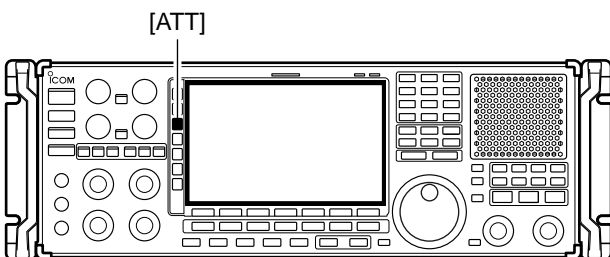

The attenuator prevents a desired signal from being distorted by a very strong signals are near the desired frequency or when very strong electric fields, such as from broadcasting stations, are near your location.

➔ Push [ATT] several times to select the desired attenuator or attenuator OFF.

- During HF bands operation, 6, 12, 18, 24, 30 dB are available.
- During 30–1150 MHz operation, 10, 20, 30 dB are available.
- During 1150–3335 MHz operation, only 20 dB is available.

➔ Push and hold [ATT] for 1 sec. to turn OFF the attenuator, when it's ON.

• HF bands

ATT 6dB 6 dB attenuation

ATT 12dB 12 dB attenuation

ATT 18dB 18 dB attenuation

ATT 24dB 24 dB attenuation

ATT 30dB 30 dB attenuation

• 30–1150 MHz

ATT 10dB 10 dB attenuation

ATT 20dB 20 dB attenuation

ATT 30dB 30 dB attenuation

• 1150–3335 MHz

ATT 20dB 20 dB attenuation

AGC function

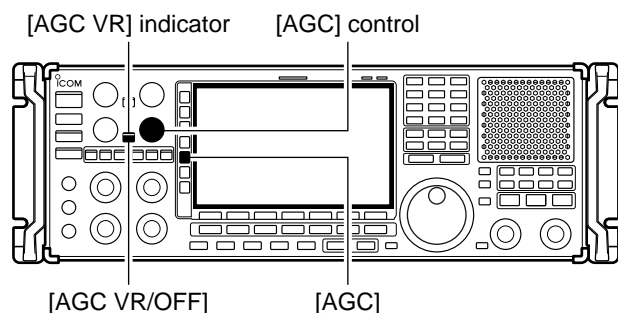

The AGC (auto gain control) controls receiver gain to produce a constant audio output level even when the received signal strength varies greatly.

The receiver has 3 preset AGC characteristics (time constant: fast, mid, slow) for non-FM, WFM or P25 mode.

The FM, WFM or P25 mode AGC time constant is fixed as 'FAST' (0.1 sec.) and AGC time constant cannot be selected.

Selecting the preset value

- ① Select non-FM, WFM or P25 mode.
- ② Push [AGC] several times to select AGC fast (FAST), AGC medium (MID) or AGC slow (SLOW).
 - Push and hold [AGC VR/OFF] for 1 sec. to turn the AGC function OFF.

Adjusting the AGC time constant

- ① Select non-FM, WFM or P25 mode.
- ② Push [AGC VR/OFF] once or twice to select AGC volume (VR), then rotate [AGC] control to adjust the AGC time constant.
 - [AGC VR] indicator lights green and "VR" appears instead of "FAST," "MID" or "SLOW."

Setting the AGC time constant preset value

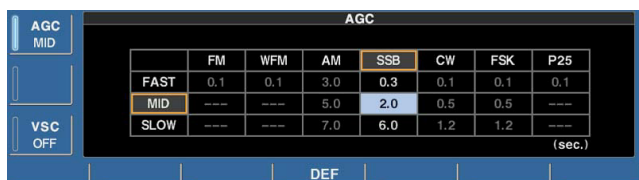

- ① Select the desired mode (not FM, WFM or P25 mode).
- ② Push and hold [AGC] for 1 sec. to enter AGC set mode.
- ③ Push [AGC] several times to select FAST time constant.
- ④ Rotate the main dial to set the desired time constant for 'AGC FAST.'
 - AGC time constant can be set between 0.1 to 8.0 sec. (depends on mode) or turned OFF.
 - Push and hold [F-4•DEF] for 1 sec. to select a default value.
- ⑤ Push [AGC] to select medium time constant.
- ⑥ Rotate the main dial to set the desired time constant for 'AGC MID.'
 - AGC time constant can be set between 0.1 to 8.0 sec. (depends on mode) or turned OFF.
 - Push and hold [F-4•DEF] for 1 sec. to select a default value.
- ⑦ Push [AGC] to select slow time constant.
- ⑧ Rotate the main dial to set the desired time constant for 'AGC SLOW.'
 - AGC time constant can be set between 0.1 to 8.0 sec. (depends on mode) or turned OFF.
 - Push and hold [F-4•DEF] for 1 sec. to select a default value.
- ⑨ Select another mode (not FM, WFM or P25). Repeat steps ③ to ⑧ if desired.
- ⑩ Push [EXIT/SET] to exit the AGC set mode screen.

Selectable AGC time constant (unit: sec.)

Mode	Default	Selectable AGC time constant
FM	0.1 (FAST)	Fixed
WFM	0.1 (FAST)	Fixed
AM	3.0 (FAST)	0.3, 0.5, 0.8, 1.2, 1.6, 2.0, 2.5, 3.0, 4.0, 5.0, 6.0, 7.0, 8.0
	5.0 (MID)	
	7.0 (SLOW)	
SSB	0.3 (FAST)	0.1, 0.2, 0.3, 0.5, 0.8, 1.2, 1.6, 2.0, 2.5, 3.0, 4.0, 5.0, 6.0
	2.0 (MID)	
	6.0 (SLOW)	
CW	0.1 (FAST)	0.1, 0.2, 0.3, 0.5, 0.8, 1.2, 1.6, 2.0, 2.5, 3.0, 4.0, 5.0, 6.0
	0.5 (MID)	
	1.2 (SLOW)	
FSK	0.1 (FAST)	0.1, 0.2, 0.3, 0.5, 0.8, 1.2, 1.6, 2.0, 2.5, 3.0, 4.0, 5.0, 6.0
	0.5 (MID)	
	1.2 (SLOW)	
P25	0.1 (FAST)	Fixed

■ Twin PBT operation

PBT (Passband Tuning) electronically narrows the IF passband width by shifting the IF frequency slightly outside of the IF filter passband, rejecting interference. The IC-R9500 uses DSP for the PBT function. Moving both [TWIN PBT] controls to the same position shifts the IF.

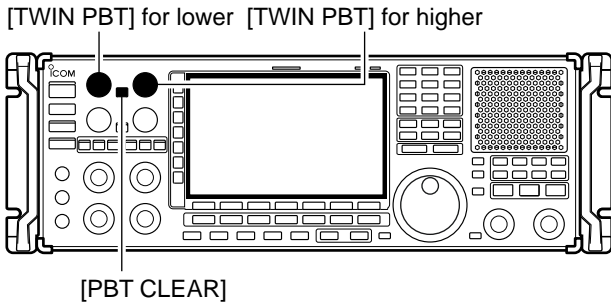

- ➔ The LCD shows the passband width and shift frequency graphically.
- ➔ Push and hold [FILTER] for 1 sec. to enter the filter set screen. Current passband width and shift frequency is displayed in the filter set screen.
- ➔ To set the [TWIN PBT] controls to the center positions, push and hold [PBT CLR] for 1 sec.

The variable range depends on the passband width and mode. The edge of the variable range is half of the passband width, and PBT is adjustable in 25 or 50 Hz steps.

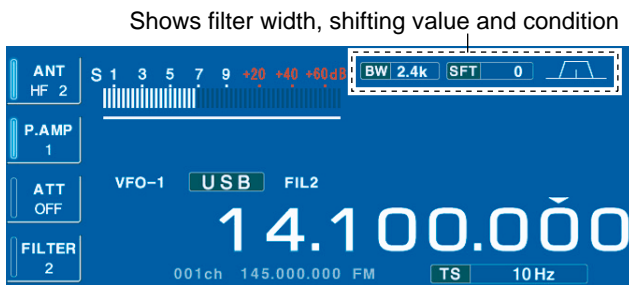

- [TWIN PBT] should normally be set to the center positions (PBT setting is cleared) when there is no interference.
- When PBT is used, the audio tone may be changed.
- Not available for FM, WFM or P25 mode.
- While rotating [TWIN PBT], noise may occur. This comes from the DSP unit and does not indicate an equipment malfunction.

• Filter set screen



• PBT operation example

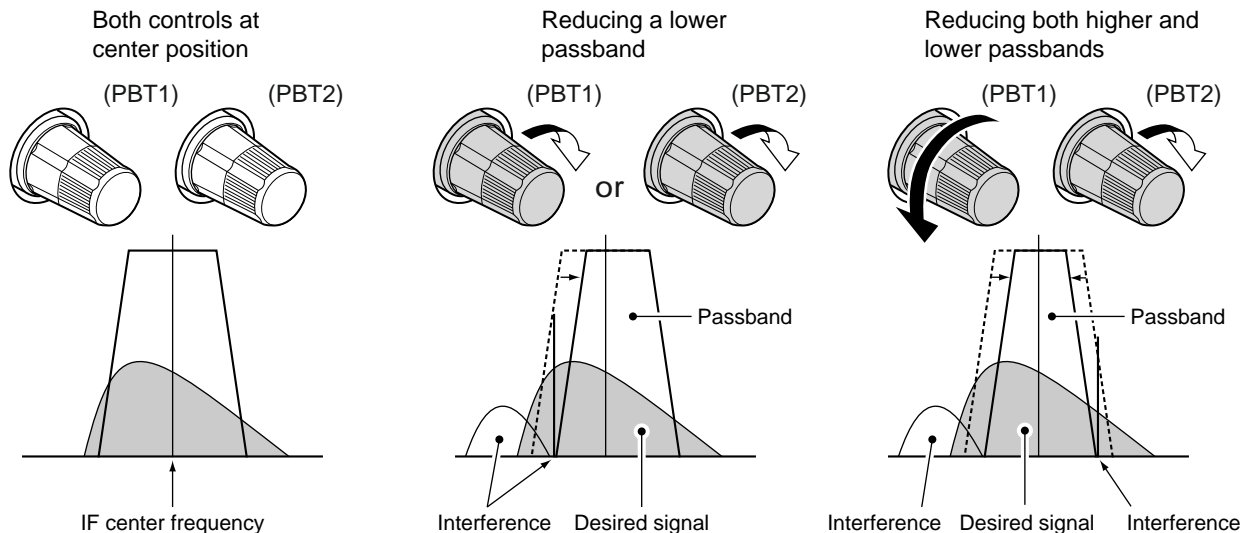

IF filter selection

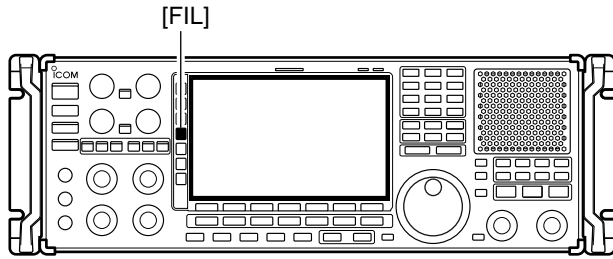

The receiver has 3 passband width IF filters for each mode.

For FM mode, the passband width is fixed and 3 passband widths are available.

For WFM and P25 mode, the passband width is fixed.

For AM mode, the passband width can be set within 200 Hz to 10 kHz in 200 Hz steps. A total of 50 passband widths are available.

For SSB and CW modes, the passband width can be set within 50 to 3600 Hz in 50 or 100 Hz steps. A total of 41 passband widths are available.

For FSK mode, the passband width can be set within 50 to 2700 Hz in 50 or 100 Hz steps. A total of 32 passband widths are available.

- ▨ The filter selection is automatically memorized in each mode.
- ▨ The PBT shift frequencies are automatically memorized for each filter.

◇ IF filter selection

- ① Select the desired mode.
- ② Push [FILTER] several times to select the IF filter 1, 2 or 3.
 - The selected passband width and filter number is displayed in the LCD.

◇ Filter passband width setting (except FM, WFM or P25 mode)



- ① Push and hold [FILTER] for 1 sec. to enter filter set screen.
- ② Select any mode except FM, WFM or P25 mode.
 - Passband widths for FM modes are fixed and cannot be set.
- ③ Push [FILTER] several times to select the desired IF filter.
- ④ While pushing [F-1•BW], rotate the main dial to set the desired passband width.
 - In AM mode, the passband width can be set within the following range.
200 Hz to 10 kHz 200 Hz steps
 - In SSB and CW modes, the passband width can be set within the following range.
50 to 500 Hz 50 Hz steps
600 to 3600 Hz 100 Hz steps
 - In FSK mode, the passband width can be set within the following range.
50 to 500 Hz 50 Hz steps
600 to 2700 Hz 100 Hz steps
 - Push and hold [F-4•DEF] for 1 sec. to select the default value.
- ⑤ Repeat steps ② to ④ if desired.
- ⑥ Push [EXIT/SET] to exit filter set screen.

▨ The PBT shift frequencies are cleared when the passband width is changed.

▨ This filter set screen graphically displays the PBT shift frequencies and operations.

◇ Roofing filter selection



The IC-R9500 has 3, 6 15 and 50 kHz roofing filters at the 1st IF frequency. The roofing filter provides interference reduction from nearby strong signals.

- ① Push and hold [FILTER] for 1 sec. to enter filter set screen.
- ② Select any mode except FM, WFM or P25 mode.
- ③ Push [F-6•ROOFING] to select the desired filter width from 50 kHz, 15 kHz (default), 6 kHz and 3 kHz.
 - Push and hold [F-4•DEF] for 1 sec. to select a default value.
- ④ Push [EXIT•SET] to exit filter set screen.

◇ DSP filter shape



The type of DSP filter shape for each SSB, SSB data and CW can be selected independently from soft and sharp.

- ① Push and hold [FILTER] for 1 sec. to enter filter set screen.
- ② Select SSB, SSB data or CW mode.
- ③ Push [F-7•SHAPE] to select the desired filter shape from soft and sharp.
- ④ Push [EXIT•SET] to exit filter set screen.

The filter shape can be set for each band (HF and 50 MHz bands), mode, and passband width (CW only) independently as your default setting in filter shape set mode.

◇ Filter shape set mode

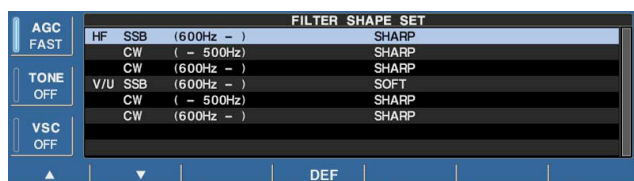

The type of DSP filter shape for each SSB and CW can be selected independently from soft and sharp.

- ① Push and hold [FILTER] for 1 sec. to enter filter set screen.
- ② Push and hold [F-7•SHAPE] for 1 sec. to enter filter shape set mode.
- ③ Push [F-1•▲] or [F-2•▼] to select the desired item.
- ④ Rotate the main dial to select the filter shape from soft and sharp.
- ⑤ Push [EXIT/SET] to exit filter shape set mode.

HF SSB (600Hz -)

Select the filter shape for SSB mode in HF bands.

SOFT

▨ The set filter shape is automatically used only when the IF filter is set to 600 Hz or wider.

CW (- 500Hz)

Select the filter shape for CW mode in HF bands.

SHARP

▨ The set filter shape is automatically used only when the IF filter is set to 500 Hz or narrower.

5 RECEIVE FUNCTIONS

◇ Filter shape set mode (continued)

CW (600Hz –)

Select the filter shape for CW mode in HF bands.

SHARP

/// The set filter shape is automatically used only when the IF filter is set to 600 Hz or wider.

V/U SSB (600Hz –)

Select the filter shape for SSB mode in VHF/UHF bands.

SOFT

/// The set filter shape is automatically used only when the IF filter is set to 600 Hz or wider.

CW (– 500Hz)

Select the filter shape for CW mode in VHF/UHF bands.

SHARP

/// The set filter shape is automatically used only when the IF filter is set to 500 Hz or narrower.

CW (600Hz –)

Select the filter shape for CW mode in VHF/UHF bands.

SHARP

/// The set filter shape is automatically used only when the IF filter is set to 600 Hz or wider.

■ Noise blanker

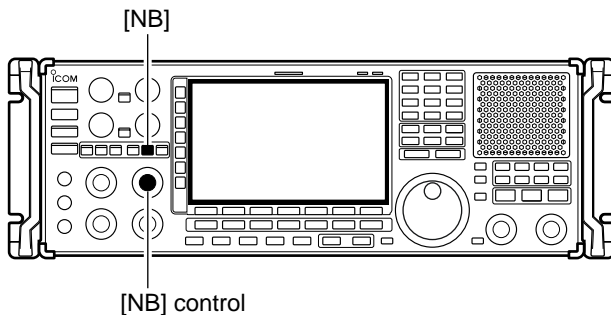

The noise blanker eliminates pulse-type noise such as the noise from car ignitions. The noise blanker is not available for FM, WFM or P25 mode.

- ① Push [NB] several times to select the noise blanker function, NB1 or NB2, and OFF.
 - [NB] indicator above this switch lights green.
 - “NB1” or “NB2” appears on the display when either is ON.
- ② Rotate [NB] control to adjust the noise blanker threshold level.

When using the noise blanker, received signals may be distorted if they are excessively strong or the noise type is other than pulsing. Turn the noise blanker OFF, or rotate [NB] control to a shallow position in this case.

◇ NB set mode

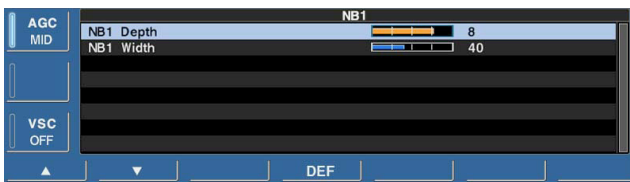

To deal with various type of noises, attenuation level and noise width can be set in NB set mode. Two of noise blanker, NB1 and NB2, can be set independently.

- ① Turn ON the desired noise blanker, NB1 or NB2.
 - When entering NB1 set mode, this step can be skipped.
- ② Push and hold [NB] for 1 sec. to enter NB1 (or NB2) set mode.
- ③ Push [F-1•▲] or [F-2•▼] to select the desired item.
- ④ Rotate the main dial to set the desired level or value.
 - Push and hold [F-4•DEF] for 1 sec. to select a default value.
- ⑤ Push [EXIT/SET] to exit NB1 (or NB2) set mode.

• NB1 set mode

NB1 Depth



Set the noise attenuation level from 1 to 10.

NB1 Width



Set the noise pulse width from 1 to 100.

• NB2 set mode

NB2 Depth



Set the noise attenuation level from 1 to 10.

NB2 Width



Set the noise pulse width from 1 to 100.

■ Noise reduction

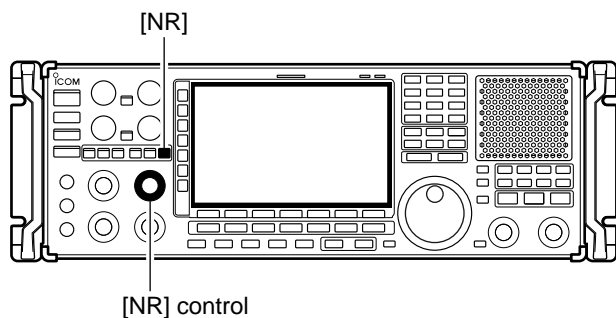

The noise reduction function reduces random noise components and enhances desired signals which are buried in noise. The DSP performs the random noise reduction function.

- ① Push the [NR] to turn the noise reduction ON.
 - [NR] indicator above this switch lights green.
- ② Rotate the [NR] control to adjust the noise reduction level.
- ③ Push the [NR] switch to turn the noise reduction OFF.
 - [NR] indicator lights off.

⚠ Setting the [NR] control too high can result in audio signal masking or distortion. Set the [NR] control for maximum readability.

■ Notch function

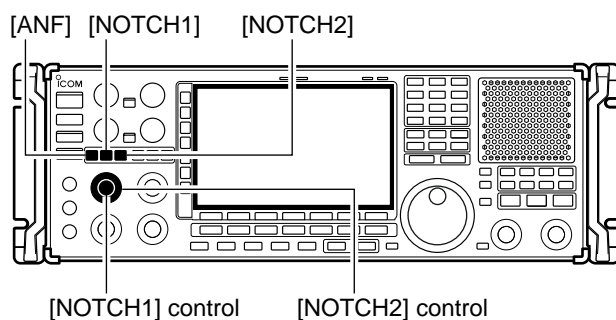

This receiver has auto and manual notch functions. The auto notch function uses DSP to automatically attenuates up to 3 beat tones, tuning signals, etc., even if they are moving. The manual notch can be set to attenuate a frequency via the [NOTCH1]/[NOTCH2] controls.

The auto notch can be used in SSB, AM, FM and WFM modes.

The manual notch can be used in SSB, CW, FSK and AM modes.

• Auto notch indication

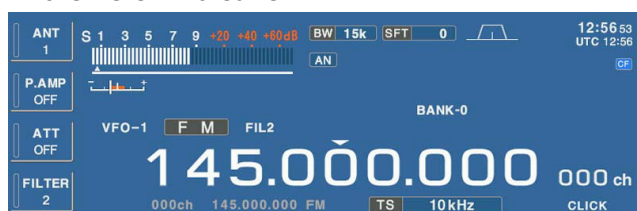

- ➔ Push [ANF] to turn the auto notch function ON and OFF in FM, WFM, AM and SSB modes.
 - [ANF] indicator above this switch lights green.
 - “AN” appears when auto notch is in use.

• Manual notch indication

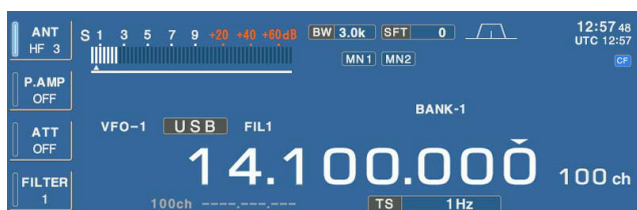

- ➔ Push [NOTCH1] or [NOTCH2] to turn the manual notch function ON and OFF, manual and OFF in AM, SSB, CW and FSK modes.
 - [NOTCH1]/[NOTCH2] indicators above these switches light green.
 - “MN1” or “MN2” appear when manual notch is in use.
 - Push and hold [NOTCH1] or [NOTCH2] for 1 sec. to select the notch filter width for manual notch from wide, middle and narrow.
 - Set to attenuate a frequency for manual notch via the [NOTCH1] or [NOTCH2] controls.

⚠ While tuning the manual notch, noise may be heard. This comes from the DSP unit and does not indicate an equipment malfunction.

Autotune function

The Automatic tuning function tunes the displayed frequency (max. AM: ± 5 kHz, SSB: ± 1 kHz, CW: 500 Hz) automatically when an off frequency signal is received. This function is active while in AM, SSB or CW is selected.

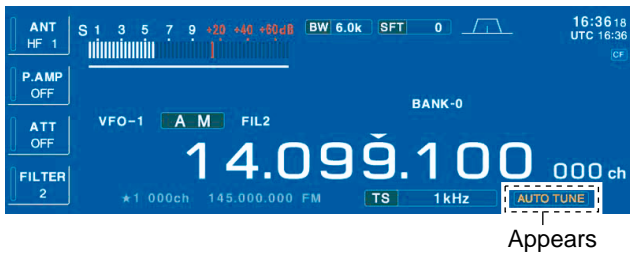
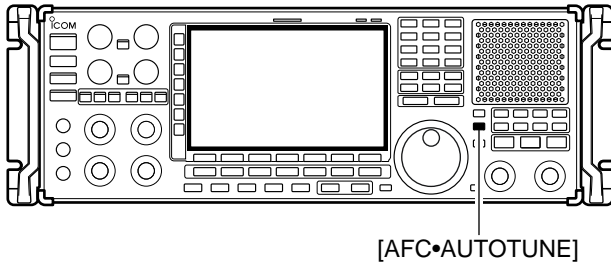

➔ Push [AUTOTUNE] (AFC) to toggle the autotune function ON or OFF.

- “**AUTO TUNE**” blinks when autotune function is activate.
- After 30 sec. has passed, the autotune function stops tuning automatically even it's still off frequency.

AFC function

The AFC stands for Automatic Frequency Control. The AFC function tunes the displayed frequency automatically when an off-center frequency is received. It activates in FM or WFM mode only.

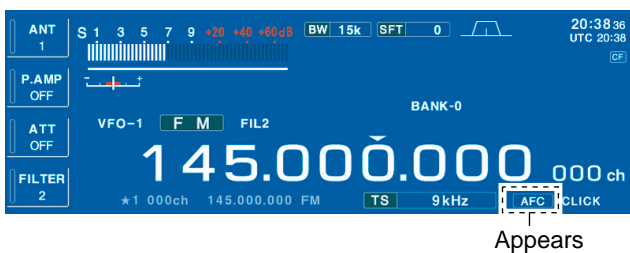
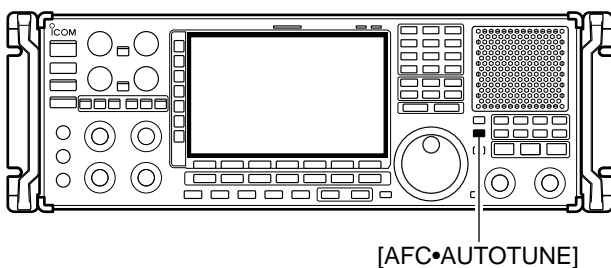

➔ Push [AFC] to toggle the AFC function ON or OFF.

- “**AFC**” appears when AFC function is active.

▨ The AFC limit can be set in the others set mode. While the AFC limit is ON, AFC stops tuning when the received frequency leaves the out of the frequency limit range.

■ About digital voice recording	6-2
■ Recording received audio	6-3
◇ Regular recording	6-3
■ Playing the recorded audio	6-4
◇ Regular playing	6-4
■ Erasing the recorded contents	6-4
■ Selecting the CF memory card or USB-Memory	6-4
■ Short recording	6-5
◇ Recording	6-5
◇ Playing back	6-5
■ Voice set mode	6-6

■ About digital voice recording

The IC-R9500 has two types of digital voice recorders. One is a regular voice recorder for which a continuous long recording is available. And the other is a short recorder which temporarily stores the previous period. A maximum message length of 30 sec. can be recorded into a RAM.

• Example— Regular recording

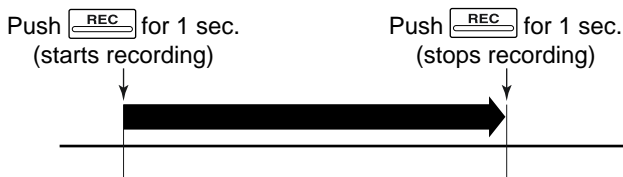

NOTE: The recording time period differ depends on the recording sound quality and memory capacity.

• Example— Short recording

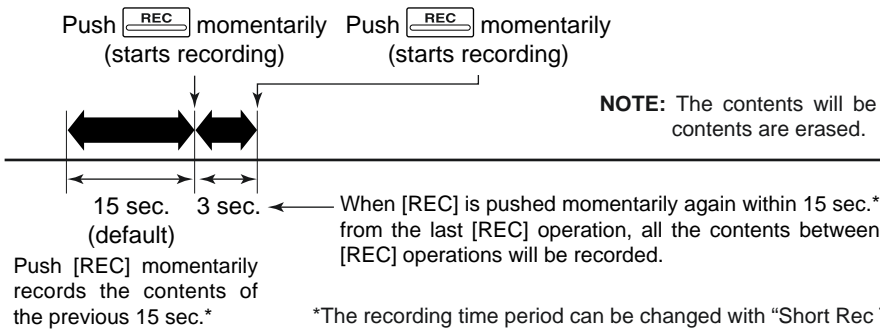

NOTE: The contents will be overwritten, and previous recorded contents are erased.

• Playing back for regular recording

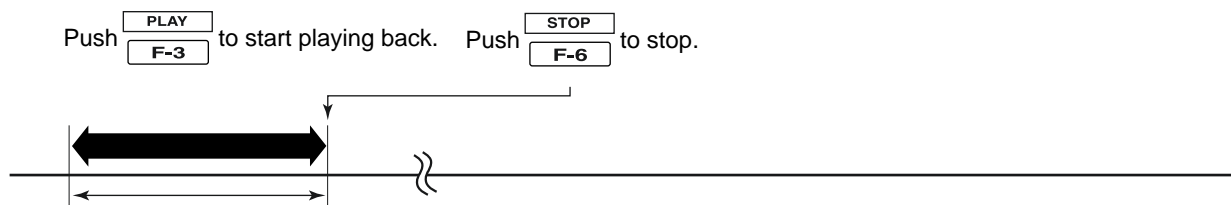

• Playing back the all contents for short recording

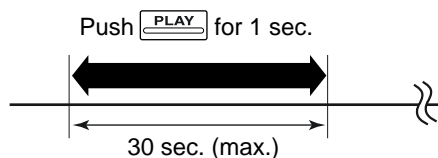

• Playing back the end of 5 sec.* for short recording

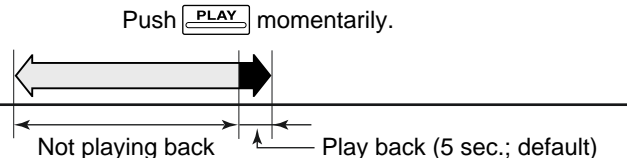

*The playing back time period can be changed with "Short Play Time" in voice set mode (p. 6-6).

Recording received audio

Regular recording

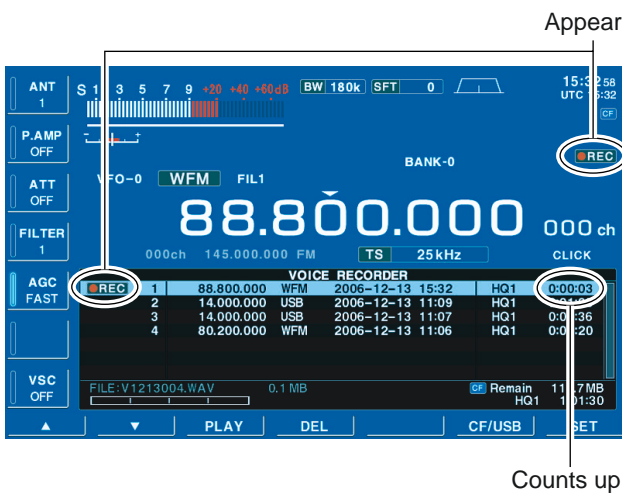
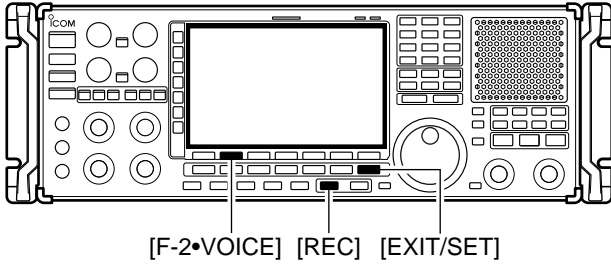

This voice recorder records not only the received audio, but also information such as operating frequency, mode, and the recording time for your future reference.

- ① Push [EXIT/SET] several times to close a multifunction screen, if necessary.
- ② Select the desired mode.
- ③ Push [F-2•VOICE] to call up the voice recorder screen.
 - Push and hold [F-6•CF/USB] for 1 sec. once or twice to select the CF card or USB-Memory, when USB memory is Inserted.
 - The recording sound quality can be set in voice set mode. (p. 6-6)
- ④ Push and hold [REC] for 1 sec. to start recording.
 - The operating frequency, mode and current date/time are programmed as the memory names automatically.
 - "● REC" indicators appear on the voice recorder screen and display's right edge, and the timer counts up.
- ⑤ Push and hold [REC] for 1 sec. to stop recording.
- ⑥ Push [EXIT/SET] to exit the voice recorder screen.

/// If you do not change any recording setting, you can start or stop recording from any screen, just push and hold [REC] for 1 sec.

■ Playing the recorded audio

◇ Regular playing

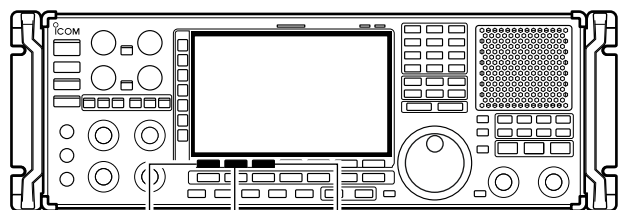

[F-1▲] [F-2▼] [F-3PLAY]

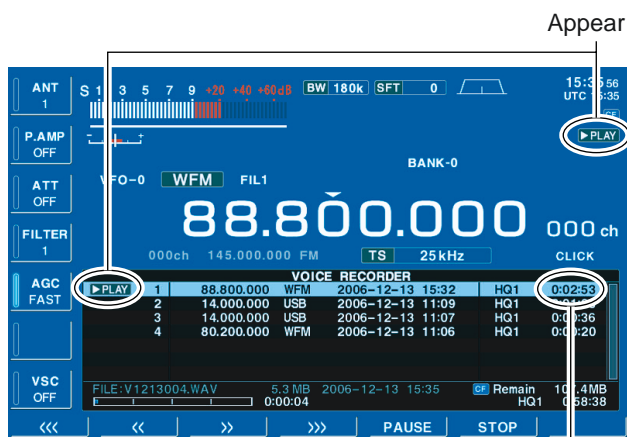

Appear

Counts down

- ① Push [EXIT/SET] several times to close a multifunction screen, if necessary.
- ② Push [F-2•VOICE] to call up the voice recorder screen.
 - Push and hold [F-6•CF/USB] for 1 sec. once or twice to select the CF card or USB-Memory, when USB memory is inserted.
- ③ Push [F-1•▲] or [F-2•▼] to select the desired voice memory to playback.
- ④ Push [F-3•PLAY] to start playback.
 - “▶PLAY” indicators appear on the voice recorder screen and display's right edge, and the timer counts down.
 - Push [F-1•<<<] when you want to rewind for 15 sec.
 - Push [F-2•<<] when you want to rewind for 5 sec.
 - Push [F-3•>>] when you want to fast forward for 5 sec.
 - Push [F-4•>>>] when you want to fast forward for 15 sec.
 - Push and hold above keys to continue rewinding or fast forwarding, respectively.
 - Push [F-5•PAUSE] when you want to pause playing back.
- ⑤ Push [F-6•STOP] to stop playback, if desired.
 - Playback is terminated automatically when all of the recorded contents in the channel are played.
- ⑥ Push [EXIT/SET] to exit the voice recorder screen.

■ Erasing the recorded contents

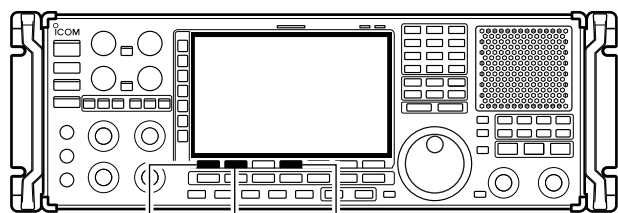

[F-1▲] [F-2▼] [F-4DEL]

The recorded contents can be erased independently by channel.

- ① Call up the voice recorder screen.
 - Push and hold [F-6•CF/USB] for 1 sec. once or twice to select the CF card or USB-Memory, when USB memory is inserted.
- ② Push [F-1•▲] or [F-2•▼] to select the desired voice memory to be erased.
- ③ Push and hold [F-4•DEL] for 1 sec. to erase the contents.
- ④ Push [EXIT/SET] to exit the voice recorder screen.

■ Select the CF memory card or USB-Memory

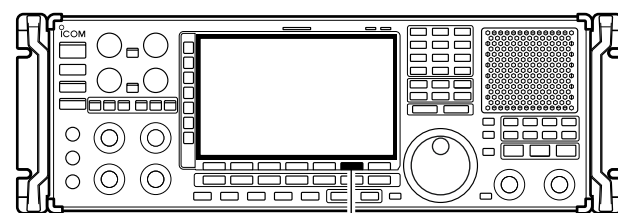

[F-6•CF/USB]

The voice recorder can record into CF memory card or USB-Memory, when USB-Memory is inserted.

- ① Call up the voice recorder screen.
- ② Push and hold [F-6•CF/USB] for 1 sec. to select the desired CF card or USB-Memory.
- ③ Operate the voice recorder as desired.
- ④ Push [EXIT/SET] to exit the voice recorder screen.

■ Short recording

To record the receiving signal contents temporarily and immediately, short recording is available. This short recording function records the 15 sec. (max.) of audio prior to when [REC] is pushed into RAM. Content is only saved when the receiver's power is ON and lost when power is removed.

This short recording is useful when you miss hearing important information from the receiver, you can listen to the important information once more. This function can be used while you are recording into CF memory card or USB-Memory as regular recording.

◇ Recording

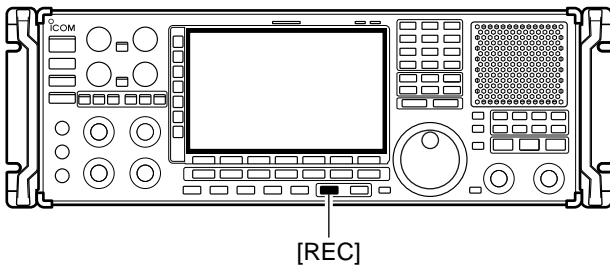

- Push [REC] momentarily to save the previous 15 sec. audio.
 - No indication appears.
 - The recordable time period can be set in voice set mode. (p. 6-6)

◇ Playing back

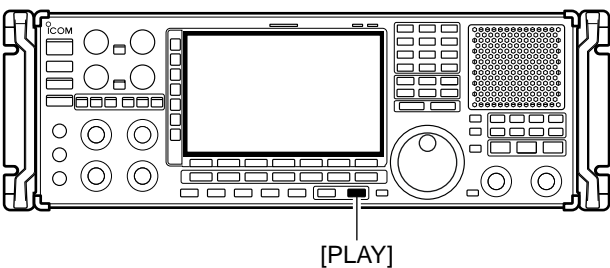

- **Short time play**
 - Push [PLAY] momentarily to play back the last 5 sec. of the short recording audio.
 - “▶PLAY” indicator appears on the display's right edge.
 - Playback is terminated automatically when all of the recorded contents, or after 5 sec.
 - The playback time period can be set in voice set mode. (p. 6-6)
- **Full time play**
 - Push and hold [PLAY] for 1 sec. to play back the short recording audio for full time.
 - “▶PLAY” indicator appears on the display's right edge.
 - Playback is terminated automatically when all of the recorded contents are played.

■ Voice set mode

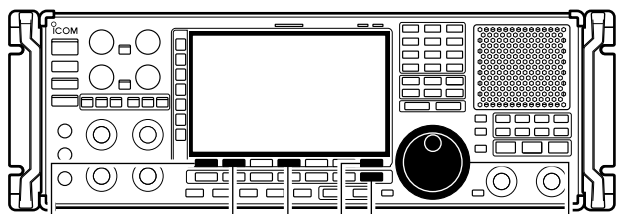

[F-1•▲] [F-2•▼] [F-4•DEF] [F-7•SET] [EXIT/SET] Main dial

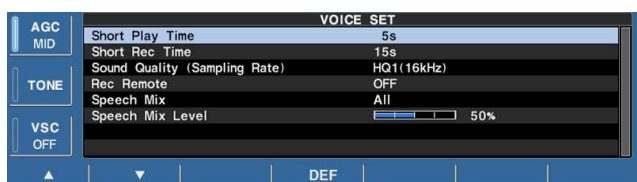

Sets the automatic monitor function, short play and normal recording times for voice recorder.

- ① Push [EXIT/SET] several times to close a multifunction screen, if necessary.
- ② Push [F-2•VOICE] to call up the voice recorder screen.
- ③ Push [F-7•SET] to enter the voice set mode screen.
- ④ Push [F-1•▲] or [F-2•▼] to select the desired item.
- ⑤ Rotate main dial to set the desired condition or value.
 - Push and hold [F-4•DEF] for 1 sec. to select the default condition or value.
- ⑥ Push [EXIT/SET] to exit the voice set mode screen.

Short Play Time	5s
Set the desired time period for the short play back (when [PLAY] is pushed momentarily).	• 3 to 10 sec. in 1 sec. steps can be set. (default: 5 sec.)
Short Rec Time	15s
Set the desired time period for one-touch recording (when [REC] is pushed momentarily).	• 5 to 30 sec. in 1 sec. steps can be set. (default: 15 sec.)
Sound Quality (Sampling Rate)	HQ1(16kHz)
Set the recording sound quality. The sampling rate setting is expressed in samples per second, and determines the sound quality. Although a higher sampling rate provides a better quality sound than a lower sampling rate, the file size becomes larger.	• SQ1 (8kHz), SQ2 (12kHz), HQ1 (16kHz), HQ2 (24kHz), SHQ (48kHz) can be set. (default: HQ1(16kHz))
Rec Remote	OFF
Turns the recording control signal ON or OFF. (default: OFF)	<ul style="list-style-type: none"> • OFF : Continues recording even when received signal disappears or squelch closes. (default) • ON : Records only when received signal appears or squelch opens and stops recording when received signal disappears or squelch closes.

■ Voice set mode (continued)

Speech Mix	All
<p>Selects the recording the speech audio from “All,” “Operation” and “OFF.”</p>	<ul style="list-style-type: none"> • All : Records the speech audio when speech operation is performed from the front panel or scan stops if “REC SPEECH” setting is ON in the others set mode (p. 11-11). • Operation: Records the speech audio when speech operation is performed from the front panel. • OFF : No recording of the speech audio.

Speech Mix Level	 50%
<p>Sets the recording speech audio level from 0 to 100% in 1% steps. (default: 50%)</p>	<ul style="list-style-type: none"> • 0% : Mutes the speech audio. <li style="text-align: center;">⋮ • 50% : Same level as receive audio. (default) <li style="text-align: center;">⋮ • 100% : Mutes the receive audio.

■ Memory channels	7-2
■ Memory channel selection	7-3
◇ Using the [M-CH]/[BANK] selectors	7-3
◇ Using the keypad	7-3
■ Memory channel programming	7-4
◇ Programming in VFO mode	7-4
◇ Programming in memory mode	7-4
■ Frequency transferring	7-5
◇ Transferring in VFO mode	7-5
◇ Transferring in memory mode	7-5
■ Memory names	7-6
◇ Editing (programming) memory names	7-6
■ Memory clearing	7-6
■ Memory list screen	7-7
◇ Selecting a memory channel using the memory list screen	7-7
◇ Confirming programmed memory channels	7-7
◇ Memory bank set	7-8
◇ Editing memory channel	7-9

Memory channels

The receiver has 1220 memory channels. Memory mode is very useful for quickly changing to often-used frequencies.

All 1220 memory channels are tuneable which means the programmed frequency can be tuned temporarily with the main dial, etc. in memory mode. memory channel.

MEMORY CHANNEL	MEMORY CHANNEL NUMBER	CAPABILITY	TRANSFER TO VFO	OVER-WRITING	CLEAR
Regular memory channels	0–999 (0–999)	For normal use. Frequency, mode, tuning step, name, P.AMP/ATT information and etc. can be programmed.	YES	YES	YES
Auto write memory channels	A00–A99 (1000–1099)	Frequencies detected during auto memory write scan are memorized into this bank in sequence. Mode and tuning step are written at the same time. Note that when “Auto MW Scan Memory Clear” in scan set mode is set as “ON” and auto write scan is started, all memories in this bank are cleared.	YES	YES	YES
Skip memory channels	S00–S99 (1100–1199)	Undesired signals such as from beacons, control-coded signals, etc., can be programmed to be skipped during programmed scan and auto memory write scan. When [MW] is pushed and held for 1 sec. while scan is paused, the displayed frequency is programmed into this bank regardless of the selected bank.	YES	YES	YES
Scan edge memory channels	P0A–P9B (1200–1219)	Memorize scan edge frequencies. 10 pairs of scan edges (P0A to P9B) are programmable (upper and lower scan edges). Mode and tuning step are automatically equalized to the last programmed channel in a pair.	YES	YES	YES

■ Memory channel selection

◇ Using the [M-CH]/[BANK] selectors

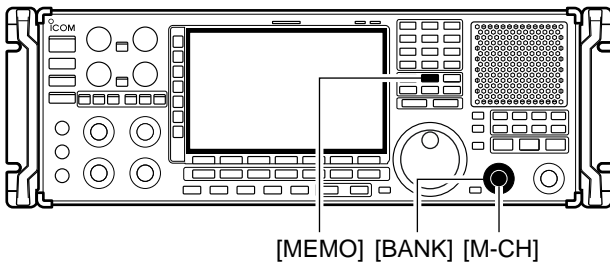

- ① Push [MEMO] to select memory mode.
- ② Rotate [BANK] to select the desired memory bank.
- ③ Rotate [M-ch] to select the desired memory channel.
- ④ To return to VFO mode, push [VFO].
 - Last operated VFO appears.
 - Or push numeral key (0–9) and [VFO] to return to the desired VFO.

✓ Bank limit function

While rotating the [M-CH] selector, memory channels are selectable in the current bank only (Bank limit ON); or selectable from all banks (Bank limit OFF).

- ➔ Push and hold [MEMO] for 1 sec. to turn the bank limit function ON (default) or OFF.
- “BANK” indicator appears or disappears.

◇ Using the keypad

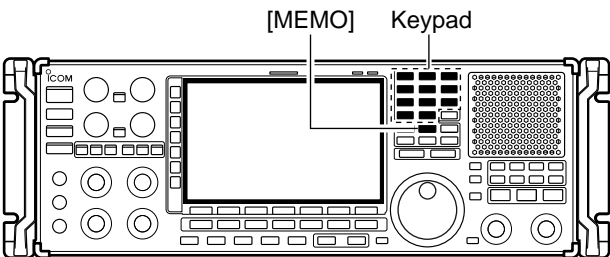

- ① Push [MEMO] to select memory mode.
- ② Push the desired memory channel number using the keypad.
 - Enter 0 to 999 to select the regular memory channels.
 - Enter 1000 to 1099 to select the auto write memory channels A00 to A99. (Push “10” before entering memory number instead of A.
 - Enter 1100 to 1199 to select the skip memory channels S00 to S99. (Push “11” before entering memory number instead of S.
 - Enter 1200 to 1219 to select the scan edge channels P0A to P9B.

1200 (P0A)	1205 (P2B)	1210 (P5A)	1215 (P7B)
1201 (P0B)	1206 (P3A)	1211 (P5B)	1216 (P8A)
1202 (P1A)	1207 (P3B)	1212 (P6A)	1217 (P8B)
1203 (P1B)	1208 (P4A)	1213 (P6B)	1218 (P9A)
1204 (P2A)	1209 (P4B)	1214 (P7A)	1219 (P9B)

- ③ Push [MEMO] to select the desired memory channel.

[EXAMPLE]

To select the memory channel 3;

- Push [3], then push [MEMO].

To select the memory channel 520;

- Push [5], [2], [0], then push [MEMO].

To select the auto write memory channel A24;

- Push [1], [0], [2], [4], then push [MEMO].

To select the skip channel S65;

- Push [1], [1], [6], [5], then push [MEMO].

To select the scan edge channel P3B;

- Push [1], [2], [0], [7], then push [MEMO].

Memory channel programming

◇ Programming in VFO mode

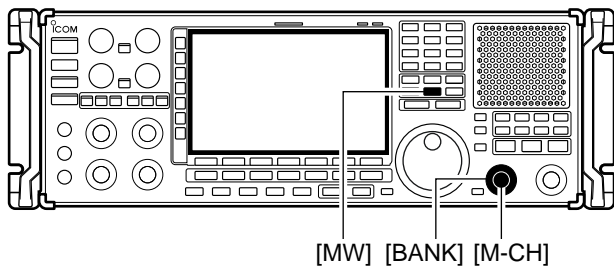

[EXAMPLE]: Programming 7.088 MHz/LSB into memory channel 12.

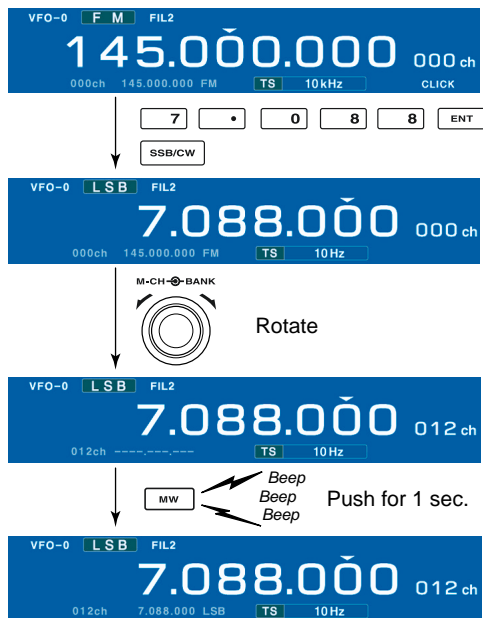

◇ Programming in memory mode

[EXAMPLE]: Programming 21.280 MHz/USB into memory channel 18.

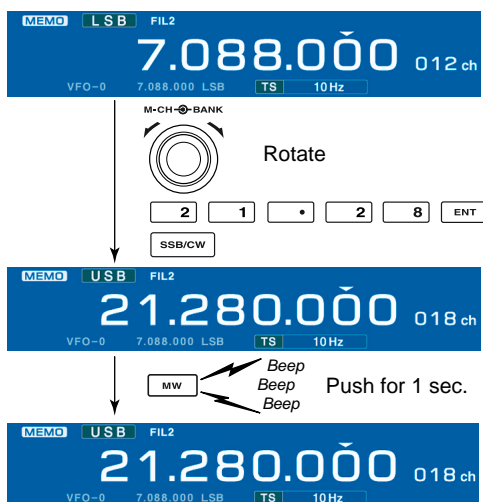

Memory channel programming can be performed either in VFO mode or in memory mode.

- ① Set the desired frequency, operating mode and filter width in VFO mode.
- ② Rotate [M-CH] (and [BANK]) to select the desired memory channel.
 - Memory list screen is convenient for selecting the desired channel.
 - Memory channel contents appear in the memory channel readout (below the frequency readout).
 - “---.---.---” appears if the selected memory channel is a blank channel (and does not have contents).
- ③ Push and hold [MW] for 1 sec. to program the displayed frequency, operating mode, etc., into the memory channel.

- ① Select the desired memory channel with [M-CH] in memory mode.
 - Memory channel contents appear in the memory channel readout (below the frequency readout).
 - “---.---.---” appears if the selected memory channel is a blank channel (and does not have contents).
- ② Set the desired frequency and operating mode in memory mode.
 - To program a blank channel, use direct frequency entry with the keypad.
- ③ Push and hold [MW] for 1 sec. to program the displayed frequency and operating mode into the memory channel.

Frequency transferring

Transferring in VFO mode

TRANSFERRING EXAMPLE IN VFO MODE
 Operating frequency : 21.320 MHz/USB (VFO)
 Contents of M-ch 16 : 14.018 MHz/CW

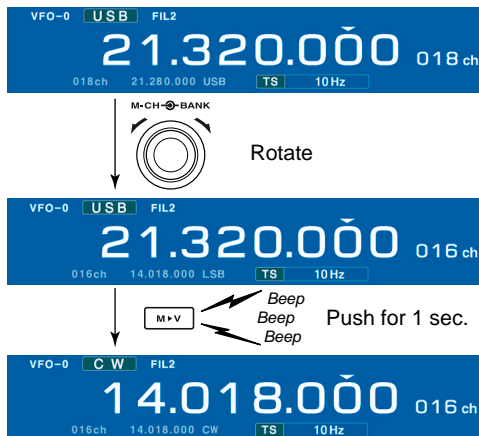

Transferring in memory mode

TRANSFERRING EXAMPLE IN MEMORY MODE
 Operating frequency : 21.320 MHz/USB (M-ch 16)
 Contents of M-ch 16 : 14.018 MHz/CW

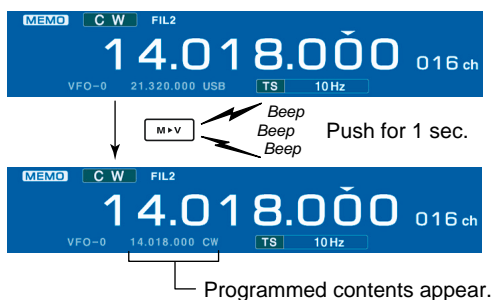

The frequency and operating mode in a memory channel can be transferred to the VFO. Frequency transferring can be performed in either VFO mode or memory mode.

This is useful for transferring programmed contents to VFO.

- ① Select VFO mode with [VFO].
- ② Select the memory channel to be transferred with [M-CH] (and [BANK]).
 - Memory list screen is convenient for selecting the desired channel.
 - Memory channel contents appear in the memory channel readout (below the frequency readout).
 - “---.---.” appears if the selected memory channel is a blank channel. In this case transferring is impossible.
- ③ Push and hold [M▶V] for 1 sec. to transfer the frequency and operating mode.
 - Transferred frequency and operating mode appear on the frequency readout.

This is useful for transferring frequency and operating mode while operating in memory mode.

- When you have changed the frequency or operating mode in the selected memory channel:
- **Displayed** frequency, mode and filter setting are transferred.
 - **Programmed** frequency and mode in the memory channel are not transferred, and they remain in the memory channel.

- ① Select the memory channel to be transferred with [M-CH] (and [BANK]) in memory mode.
 - And, set the frequency or operating mode if required.
- ② Push and hold [M▶V] for 1 sec. to transfer the frequency and operating mode.
 - Displayed frequency and operating mode are transferred to the VFO.
- ③ To return to VFO mode, push [VFO] momentarily.

Memory names

All memory channels (including scan edges) can be tagged with alphanumeric names of up to 10 characters each.

Capital letters, small letters, numerals, some symbols (! # \$ % & ¥ ? " ' ` ^ + - * / . , ; = < > () [] { } | _ ~ @) and spaces can be used.

Editing (programming) memory names

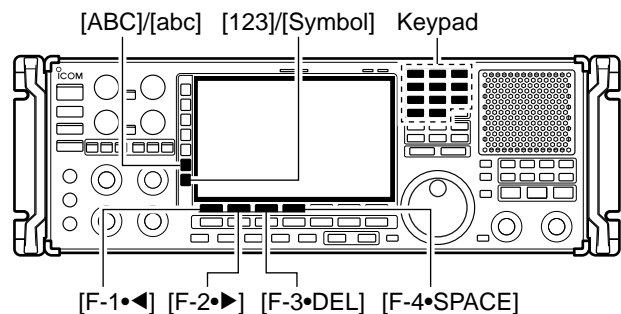

- ① Push [EXIT/SET] several times to close a multifunction screen, if necessary.
- ② Push [F-4•MEMORY] to select memory list screen.
- ③ Select the desired memory channel.
- ④ Push [F-4•NAME] to edit memory channel name.
 - A cursor appears and blinks.
 - Memory channel names of blank channels cannot be edited.
- ⑤ Input the desired character by rotating the main dial or by editing the keypad for number input.
 - Push [ABC] or [abc] to toggle capital and small letters.
 - Push [123] or [Symbol] to toggle numerals and symbols.
 - Push [F-1•◀] or [F-2•▶] for cursor movement.
 - Push [F-3•DEL] to delete the selected character.
 - Push [F-4•SPACE] to input a space.
 - Using the receiver's keypad, [0]–[9], can also enter numerals.
- ⑥ Push [EXIT/SET] to input and set the name.
 - The cursor disappears.
- ⑦ Repeat steps ③ to ⑥ to program another memory channel's name, if desired.
- ⑧ Push [EXIT/SET] to exit memory list screen.



Memory clearing

Any unused memory channels can be cleared. The cleared memory channels become blank channels.

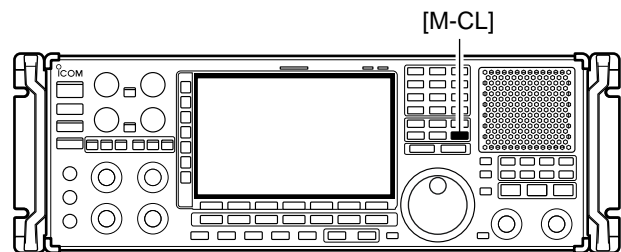

- ① Select memory mode with [MEMO].
- ② Push [F-4•MEMORY] to select memory list screen.
- ③ Select the desired memory channel with [M-CH].
- ④ Push and hold [M-CL] for 1 sec. to clear the contents.
 - The programmed frequency and operating mode disappear.
- ⑤ To clear other memory channels, repeat steps ③ and ④.

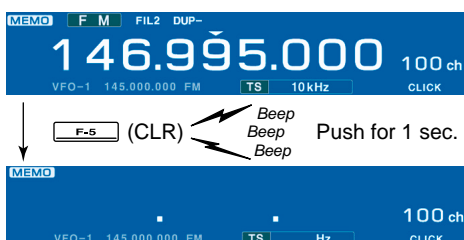

■ Memory list screen

The memory list screen simultaneously shows 9 memory channels and their programmed contents. 15 memory channels can be displayed in the wide memory list screen.

You can select a desired memory channel from memory list screen.

◇ Selecting a memory channel using the memory list screen

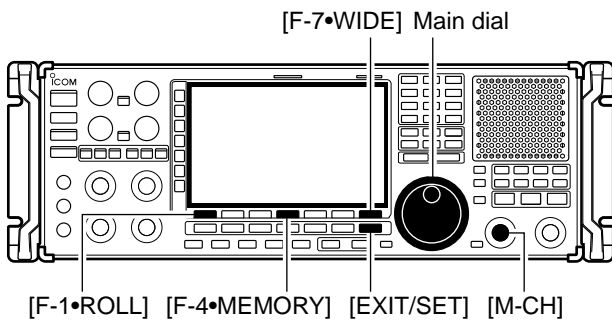

- ① Push [EXIT/SET] several times to close a multifunction screen, if necessary.
- ② Push [F-4•MEMORY] to select memory list screen.
 - [F-7•WIDE] switches the standard and wide screens.
- ③ While pushing [F-1•ROLL], rotate the main dial to select the desired memory channel.
 - [M-CH] can also be used.
- ④ Push [EXIT/SET] to exit memory list screen.

• Memory list screen

		MEMORY				BANK-0
AGC	96	-----	-----	-----	-----	
FAST	97	-----	-----	-----	-----	
TONE	98	-----	-----	-----	-----	
OFF	99	-----	-----	-----	-----	
VSC	0	▶ 145.000.000	FM	FIL2	10k	
OFF	1	145.000.000	FM	FIL2	10k	
	2	145.000.000	FM	FIL2	10k	
	3	145.000.000	FM	FIL2	10k	
	4	145.000.000	FM	FIL2	10k	

ROLL SET SELECT NAME SKIP EDT/BANK WIDE

◇ Confirming programmed memory channels

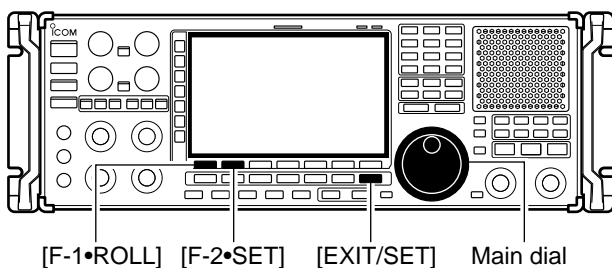

- ① Select memory list screen as described above.
- ② While pushing [F-1•ROLL], rotate the main dial to scroll the screen.
- ③ Push [F-2•SET] to select the highlighted memory channel, if desired.
 - “▶” appears beside the selected memory channel number in the memory list screen and the selected memory channel contents are displayed below the frequency readout.
- ④ Push [EXIT/SET] to exit memory list screen.

◇ Memory bank set

Setting bank limit function for memory channel selection, for memory scan can be set in bank set mode or programming bank name.

- ① Select memory list screen as described at previous page.
- ② Push and hold [F-6•EDT/BANK] for 1 sec. to display the memory bank set mode.
- ③ Push [F-1•▲] or [F-2•▼] to select the desired item.
- ④ Rotate the main dial to set the desired setting.
 - Push and hold [F-4•DEF] for 1 sec. to select a default value.
- ⑤ Push [EXIT/SET] to return to memory list screen.

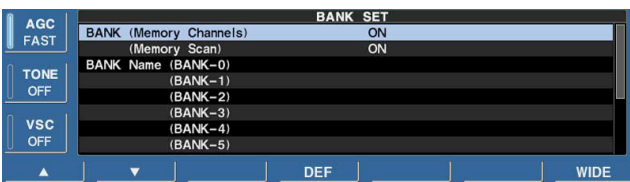
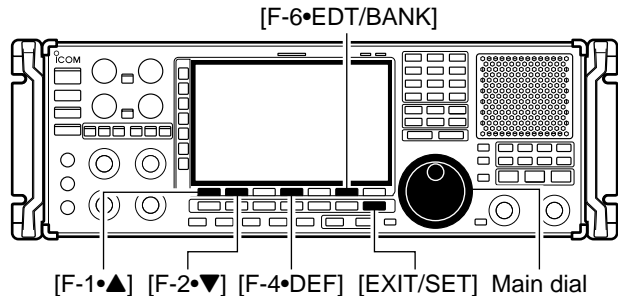

BANK (Memory Channels)	ON
Selects the bank limit function for memory channel selection from ON and OFF. (default: ON)	

BANK (Memory Scan)	ON
Selects the bank limit function for memory scan from ON and OFF. (default: ON)	

• Programming bank names

Capital letters, small letters, numerals, some symbols (! # \$ % & ¥ ? " ' ` ^ + - * / . , ; = < > () [] { } | _ ~ @) and spaces can be used for bank name programming.

- ① Push [F-1•▲] or [F-2•▼] to select the desired memory bank.
- ② Push [F-5•EDIT] to edit memory bank name.
 - A cursor appears and blinks.
- ③ Input the desired character by rotating the main dial or by editing the keypad for number input.
 - Push [ABC] or [abc] to toggle capital and small letters.
 - Push [123] or [Symbol] to toggle numerals and symbols.
 - Push [F-1•◀] or [F-2•▶] for cursor movement.
 - Push [F-3•DEL] to delete the selected character.
 - Push [F-4•SPACE] to input a space.
 - Using the receiver's keypad, [0]–[9], can also enter numerals.
- ④ Push [EXIT/SET] to input and set the name.
 - The cursor disappears.
- ⑤ Repeat steps ① to ④ to program another memory bank's name, if desired.
- ⑥ Push [EXIT/SET] to return to memory list screen.

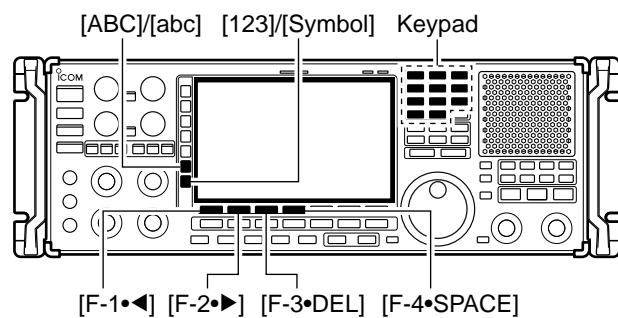

◇ Editing memory channel

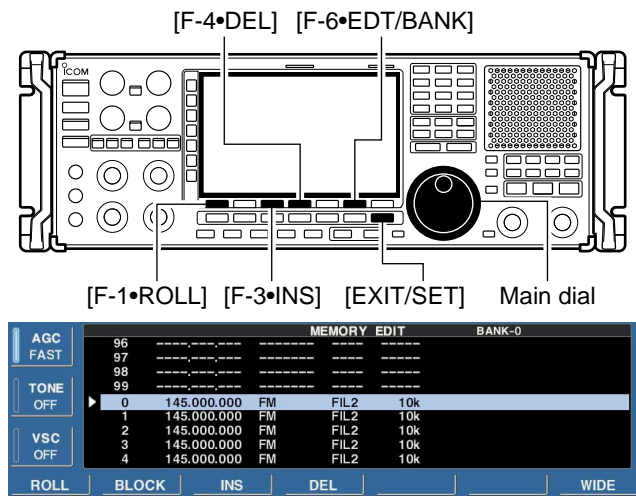

- ① Select memory list screen as described at page 7-7.
- ② Push [F-6•EDT/BANK] to display the memory edit screen.
- ③ While pushing and holding [F-1•ROLL], rotate main dial to select the desired memory channel.
 - [M-CH] can also be used.
- ④ Push [F-3•INS] to insert the new channel above the highlighted channel. Or push and hold [F-4•DEL] for 1 sec. to delete the highlighted memory channel.
 - When inserting a channel, below the channels scroll down.
 - When deleting a channel, remaining channels scroll up.
- ⑤ Push [EXIT/SET] to return to memory list screen.

• Editing plural channels

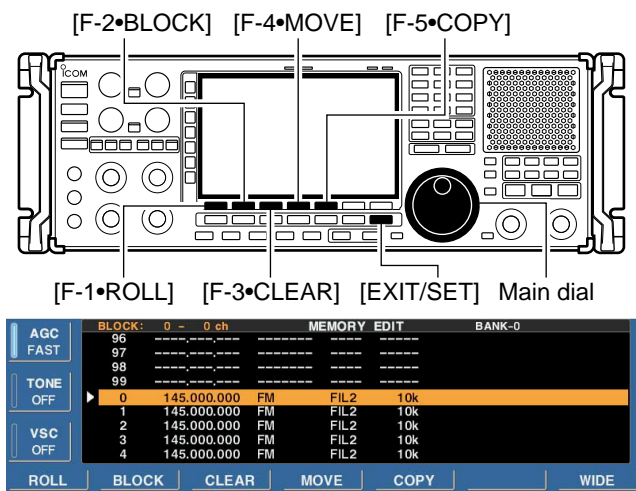

- ① While pushing and holding [F-1•ROLL], rotate main dial to select the desired memory channel.
 - [M-CH] can also be used.
- ② Push [F-2•BLOCK] to set the selected memory channel.
 - Background color of selected channel changes orange.
 - Selected channel number is displayed.
- ③ While pushing and holding [F-1•ROLL], rotate main dial to select another edge channel.
 - [M-CH] can also be used.
- ④ Push [F-2•BLOCK] to set the selected memory channel.
 - Background color of selected channels changes orange.
- ⑤ Operate the following actions, if desired.

• Clear channels:

- Push and hold [F-3•CLEAR] for 1 sec. to clear the selected channels.
 - Remaining channels scroll up.

• Move channels:

- ① While pushing and holding [F-1•ROLL], rotate main dial to select the channel which you want to move the selected channels.
 - [M-CH] can also be used.
- ② Push and hold [F-3•MOVE] for 1 sec. to move the the channels.

• Copy channels:

- ① While pushing and holding [F-1•ROLL], rotate main dial to select the channel which you want to inset the selected channels.
 - [M-CH] can also be used.
- ② Push and hold [F-4•COPY] for 1 sec. to copy the channels.

- ⑥ Push [EXIT/SET] to return to memory list screen.

■ Scan types	8-2
■ Preparation	8-3
■ Voice squelch control function	8-3
■ Scan set mode	8-4
■ Priority scan	8-5
◇ Setting	8-5
◇ Priority scan operation	8-5
■ Programmed scan	8-6
◇ Setting	8-6
◇ Program scan operation	8-7
■ ΔF scan	8-8
◇ Setting	8-8
◇ ΔF scan operation	8-8
■ Fine programmed scan/fine ΔF scan operation	8-9
■ Auto memory write scan operation.....	8-10
■ Memory scan	8-11
◇ Setting	8-11
◇ Memory scan operation	8-11
◇ Programming the select memory scan setting	8-12
◇ Select memory scan operation	8-13
◇ Mode select memory scan operation	8-14
■ Skip scan	8-15
◇ Specifying skip channels	8-15
◇ Programming skip frequencies (for programming scan)	8-15
◇ Skip scan setting	8-15
■ Tone scan	8-16
■ Scan resume condition.....	8-17
■ Scan speed	8-18
■ Scan delay	8-18

Scan types

PROGRAMMED SCAN

Repeatedly scans between two scan edge frequencies (scan edge memory channels PxA and PxB).

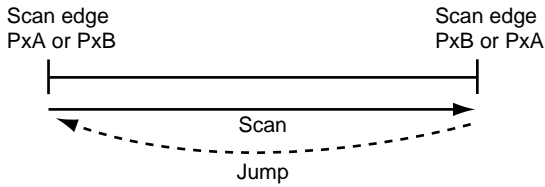

This scan operates in both VFO and memory modes.

ΔF SCAN

Repeatedly scans within ΔF span.

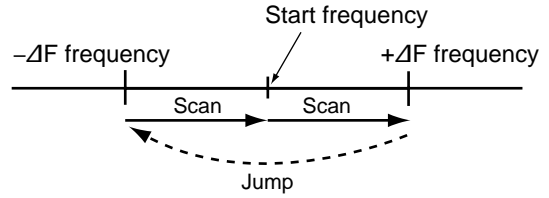

This scan operates in both VFO and memory modes.

MEMORY SCAN

Repeatedly scans all programmed memory channels.

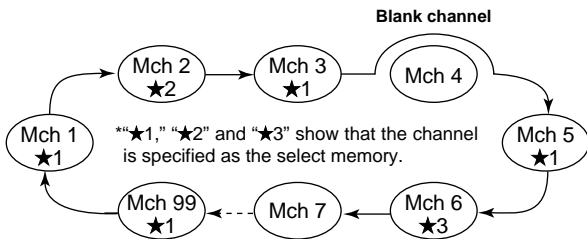

This scan operates in memory mode.

SELECT MEMORY SCAN

Repeatedly scans all or one of 9 select memory channels.

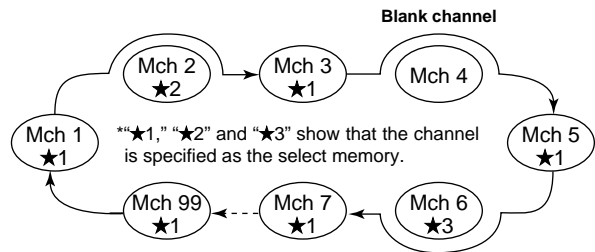

This scan operates in memory mode.

PRIORITY SCAN

Continuously switches between monitoring displayed frequency and specified memory channel (priority channel).

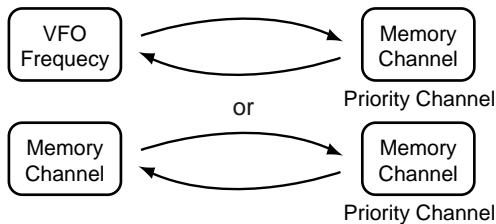

This scan operates in both VFO and memory modes.

MODE SELECT MEMORY SCAN

Repeatedly scans a selected mode (ignoring other modes) while memory scanning.

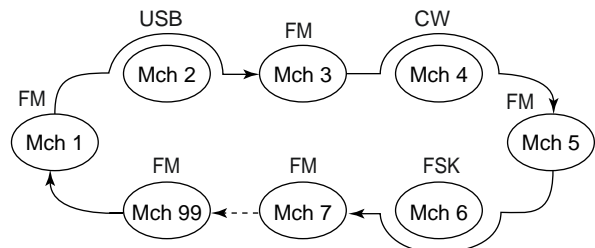

This scan operates in memory mode.

FINE SCAN

Scans in 10 Hz steps when squelch is open (around the signal) while program scan or ΔF scan.

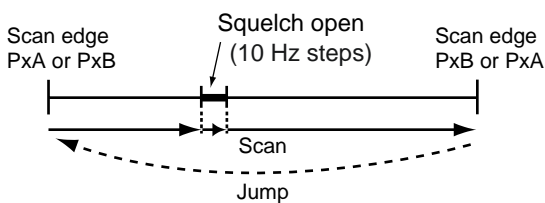

This scan operates in both VFO and memory modes.

AUTO MEMORY WRITE SCAN

Auto memory write scan operates in the same way as programmed scan. However, when a signal is received, the received frequency is automatically written into a memory channel in the auto write bank.

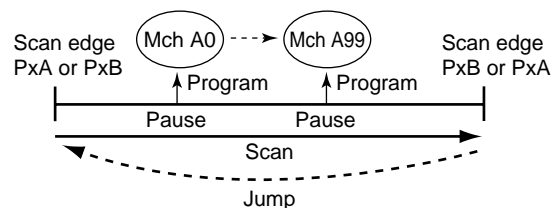

This scan operates in both VFO and memory modes.

■ Preparation

• Channels

For programmed scan:

Program scan edge frequencies into scan edge memory channels PxA and PxB.

For ΔF scan:

Set the ΔF span (ΔF scan range) in the scan screen.

For memory scan:

Program 2 or more memory channels except scan edge memory channels.

For select memory scan:

Designate 2 or more memory channels as select memory channels. To designate the channel as a select memory channel, choose a memory channel, then push [F-3•SELECT] in the scan screen (memory mode) or in the memory list screen.

• Scan resume ON/OFF

You can select the scan to resume or cancel when a signal is detected. Scan resume ON/OFF must be set before activating a scan. See p. 8-17 for ON/OFF setting and scan resume condition details.

• Scan speed

Scan speed can be adjusted by [SPEED] controller. See p. 8-18 for details.

• Squelch condition

SCAN STARTS WITH	PROGRAMMED SCAN	MEMORY SCAN
SQUELCH OPEN	The scan continues until it is stopped manually, and does not pause even if it detects signals.	Scan pauses on each channel when the scan resume is ON; not applicable when OFF.
SQUELCH CLOSED	Scan stops when a signal is detected. If you set 'SCAN RESUME' to 'DELAY,' the scan pauses according to [DELAY] control when detecting a signal, then resumes. When a signal disappears while scan is paused, scan resumes 2–20 sec. later.	

■ Voice squelch control function

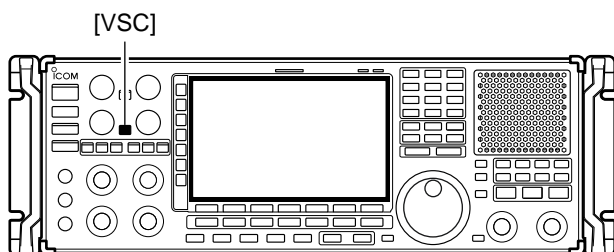

This function is useful when you don't want unmodulated signals pausing or cancelling a scan. When the voice squelch control function is activated, the receiver checks received signals for voice components.

If a receiver signal includes voice components, and the tone of the voice components changes within 1 sec., scan pauses (or stops). If the received signal includes no voice components or the tone of the voice components does not change within 1 sec., scan resumes.

➔ While a phone mode (FM, WFM, SSB, AM) is selected, push [VSC] to switch the VSC (Voice Squelch Control) function ON and OFF.

- “[VSC]” appears when the function is activated.

- The VSC function activates for any scan.
- The VSC function resumes the scan on unmodulated signals, regardless of whether the scan resume condition is set to ON or OFF.

Scan set mode

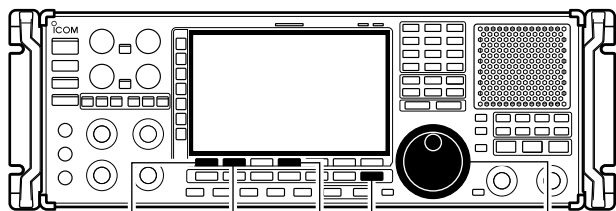

[F-1•▲] [F-2•▼] [F-4•DEF] [EXIT/SET] Main dial

This set mode is used to set the skip scan setting, memory clear condition for auto memory write channels and appearing scan screen setting.

- ① Push [F-5•SCAN] to select scan screen.
- ② Push [F-7•SET] to select scan set mode.
- ③ Push [F-1•▲] or [F-2•▼] to select the desired item.
- ④ Rotate the main dial to select the desired condition.
 - Push and hold [F-4•DEF] for 1 sec. to select the default setting.
- ⑤ Push [EXIT/SET] to return to scan menu.

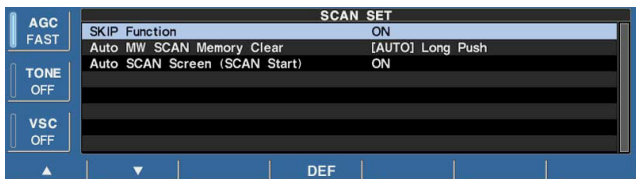

SKIP Function	ON
Select the skip scan function ON or OFF.	<ul style="list-style-type: none"> • ON : Scan skips the programmed memory channel in the skip memory bank while scanning (default) • OFF : Skip function OFF

Auto MW SCAN Memory Clear	[AUTO] Long Push
Set the clearing condition for the auto memory write scan's memories channels.	<ul style="list-style-type: none"> • ON : Auto memory channels are cleared when starting the auto memory write scan. • [AUTO] Long Push : Auto memory channels are cleared when pushing and holding [AUTO]. (default) • OFF : Auto memory channels must be cleared manually and auto memory write scan stops when 100 channels (A00 to A99) are wrote.

Auto SCAN Screen (SCAN Start)	ON
Set the automatic scan screen ON function when starting a scan.	<ul style="list-style-type: none"> • ON : When starting a scan, scan screen appears automatically. (default) • OFF : Scan screen does not appear until [F-5•SCAN] is pushed.

Priority scan

Setting

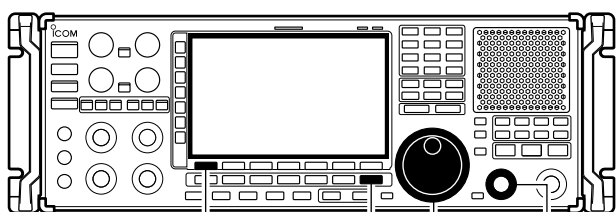

[F-1•PRIO] [EXIT/SET] Main dial [BANK]

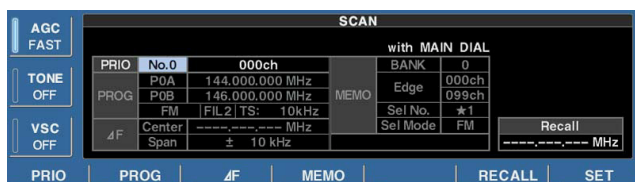

Priority scan monitors a specified frequency (the priority channel) once every 1–16 sec. (programmable) during any operation, such as receiving, scanning other channels, etc. A total of 10 priority channels can be programmed.

- ① Push [EXIT/SET] several times to close a multifunction screen, if necessary.
- ② Push [F-5•SCAN] to select scan setting screen.
- ③ Push [F-1•PRIO] once to enter priority channel selection.
- ④ Rotate the main dial to select priority channel number.
 - No.1 to No.9 are available.
- ⑤ Push [F-1•PRIO], then rotate main dial to select the desired memory channel as priority channel.
- ⑥ Push [F-1•PRIO] to set the priority scan.
- ⑦ Set the desired VFO or memory channel.

Priority scan operation

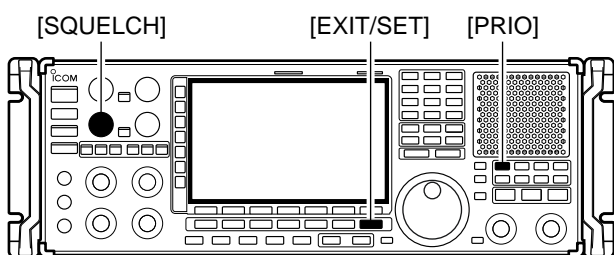

Scan indicator and Priority scan number appear

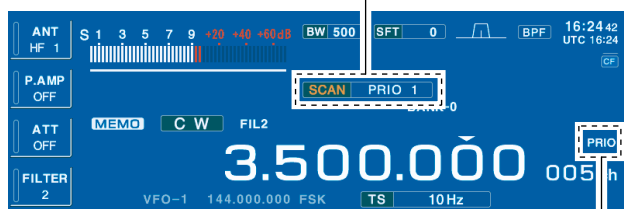

Priority channel indicator

- ① Push [EXIT/SET] several times to close a multifunction screen, if necessary.
- ② Select the desired VFO or memory channel.
- ③ Select the desired operating mode when VFO is selected.
 - The operating mode can also be changed while scanning.
- ④ Set [SQUELCH] control open or closed.
 - See page 8-3 for squelch condition.
- ⑤ Push [PRIO] to start the priority scan.
 - “**PRIORITY SCAN**” blinks while scan screen is displayed.
 - “**PRIO**” blinks while monitoring the priority channel.
- ⑥ To cancel the scan, push [PRIO].
 - Pushing [F5•STOP] also cancels the scan.
 - Pushing [EXIT/SET] closes the scan screen, if displayed.

Monitoring the Priority channel

- ① Push and hold [PRIO] for 1 sec. to monitor the priority channel.
 - “**PRIO**” blinks while monitoring the priority channel.
- ② To cancel the monitoring, push [PRIO].

■ Programmed scan

◇ Setting

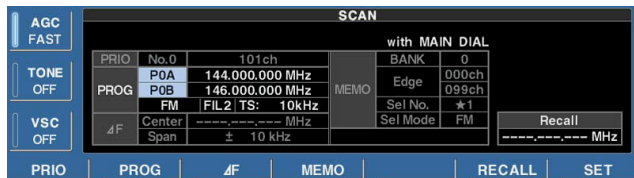
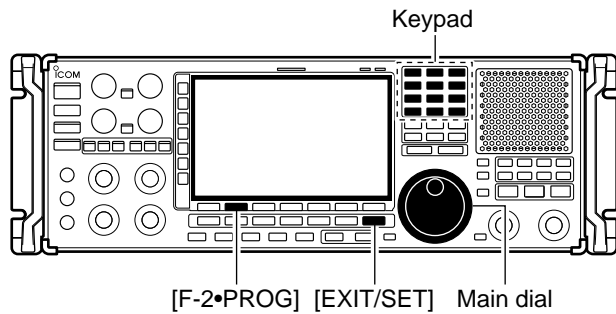

Programmed scan searches for signals within a specified frequency range, using the selected tuning step increments. The result is like 'automatically' rotating of the main dial.

- ① Push [EXIT/SET] several times to close a multifunction screen, if necessary.
- ② Push [F-5•SCAN] to select scan setting screen.
- ③ Push [F-2•PROG] once to enter the programmed scan selection mode.
- ④ Rotate the main dial to select the desired scan edges.
 - A pair of P0A and P0B to P9A and P9B are available.
- ⑤ Push [F-2•PROG] to enter the start edge frequency programming, then edit the desired frequency using the keypad.
- ⑥ Push [F-2•PROG] to enter the end edge frequency programming, then edit the desired frequency using the keypad.
- ⑦ Push [F-2•PROG] to enter the operating mode selection, then rotate main dial to select the desired operating mode.
- ⑧ Push [F-2•PROG] to enter the filter selection, then rotate main dial to select the desired filter.
- ⑨ Push [F-2•PROG] to enter the tuning steps selection, then rotate main dial or edit using the keypad to select the desired tuning steps.
- ⑩ Push [F-2•PROG] to set the programmed scan.

◇ Programmed scan operation

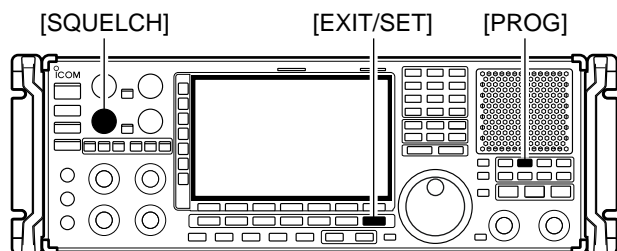

Scan indicator and Program scan number appear



- ① Push [EXIT/SET] several times to close a multifunction screen, if necessary.
- ② Select the desired VFO or memory channel.
- ③ Select the desired operating mode.
 - The operating mode can also be changed while scanning.
- ④ Set [SQUELCH] control open or closed.
 - See page 8-3 for squelch condition.
- ⑤ Push [PROG] to start the programmed scan.
 - Scan screen appears.
 - "PROGRAM SCAN" and decimal points blink while scanning.
 - Push numeral key (0–9) to change to the other edges.
- ⑥ When the scan detects a signal, the scan stops, pauses or ignores it depending on the resume setting and the squelch condition.
- ⑦ To cancel the scan, push [PROG].
 - Pushing [F5•STOP] also cancels the scan.
 - Pushing [EXIT/SET] closes the scan screen.
- ⑧ Push and hold [F-6•RECALL] for 1 sec. to recall the frequency that is set before starting the scan, if desired.

⚡ If the same frequencies are programmed into the scan edge memory channel PxA and PxB, programmed scan does not start.

✓ For your convenience

Ten programmed scans can be selected directly from the keypad. Then the scan starts immediately.

➡ Push numeral key (0–9) then push [PROG] to start the desired programmed scan.

■ Fine programmed scan/fine ΔF scan operation

In fine scan (programmed or ΔF), the scan speed decreases when the squelch opens, but the receiver keeps scanning. The scanning tuning step shifts from 50 Hz to 10 Hz when the squelch opens.

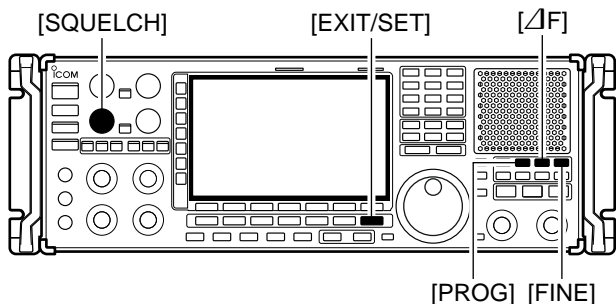

- ① Push [EXIT/SET] several times to close a multifunction screen, if necessary.
- ② Push [F-5•SCAN] to select the scan screen.
- ③ Set for programmed scan or ΔF scan as described at p.8-6 and p.8-8.
- ④ Push [PROG] or [ΔF] to start a scan.
 - “PROGRAM SCAN” or “ΔF SCAN” and decimal points blink while scanning.
- ⑤ Push [FINE] to start a fine scan.
 - “FINE PROGRAM SCAN” or “FINE ΔF SCAN” blinks instead of “PROGRAM SCAN” or “ΔF SCAN,” respectively.
- ⑥ When the scan detects a signal, the scan speed decreases but scan does not stop.
- ⑦ Push [PROG] or [ΔF] to stop the scan; push [FINE] to cancel the fine scan.
 - Pushing [F5•STOP] also cancels the scan.
 - Pushing [EXIT/SET] closes the scan screen.
- ⑧ Push and hold [F-6•RECALL] for 1 sec. to recall the frequency that is set before starting the scan, if desired.

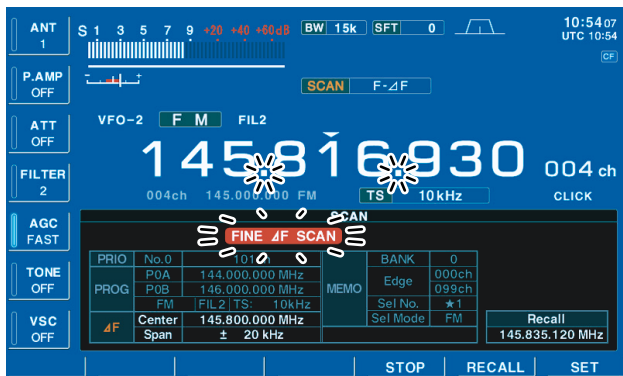

Auto memory write scan operation

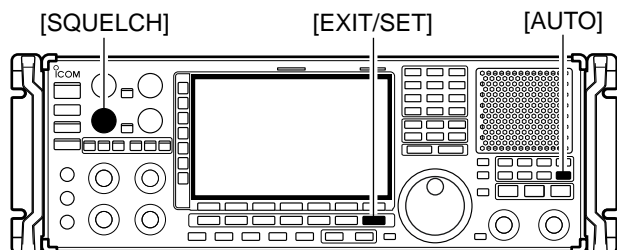

Scan indicator and Auto memory write scan number appear

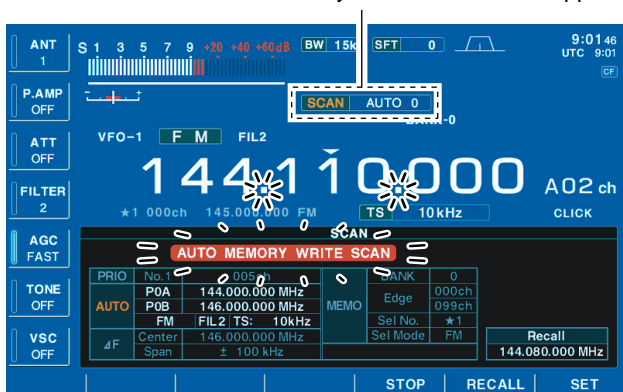

Auto memory write scan operates in the same way as programmed scan. However, when a signal is received, the received frequency is automatically written into a memory channel in the auto write bank (A00–A99).

- ① Push [EXIT/SET] several times to close a multifunction screen, if necessary.
- ② Select the desired VFO or memory channel.
- ③ Select the desired operating mode.
 - The operating mode can also be changed while scanning.
- ④ Set [SQUELCH] control open or closed.
 - See page 8-3 for squelch condition.
- ⑤ Push [AUTO] to start the auto memory write scan.
 - Selected programmed scan start.
 - Scan screen appears.
 - “**AUTO MEMORY WRITE SCAN**” and decimal points blink while scanning.
 - Push numeral key (0–9) to change to the other edges.
- ⑥ When the scan detects a signal, the scan stops, pauses or ignores it depending on the resume setting and the squelch condition.
 - The received frequency is automatically written into a blank memory channel in the auto write bank.
- ⑦ To cancel the scan, push [AUTO].
 - Pushing [F5•STOP] also cancels the scan.
 - Pushing [EXIT/SET] closes the scan screen.
- ⑧ Push and hold [F-6•RECALL] for 1 sec. to recall the frequency that was set before starting the scan, if desired.

✓ For your convenience

Ten auto memory write scans can be selected directly from the keypad. Then the scan starts immediately.

- ➡ Push numeral key (0–9) then push [AUTO] to start the desired programmed scan.

- ▨ The memory clear setting of the auto write bank can be selected from the starting auto memory write scan, by pushing and holding [AUTO], or manually.
- ▨ See scan set mode (p. 8-4) for Auto MW SCAN Memory Clear details.

Memory scan

Setting

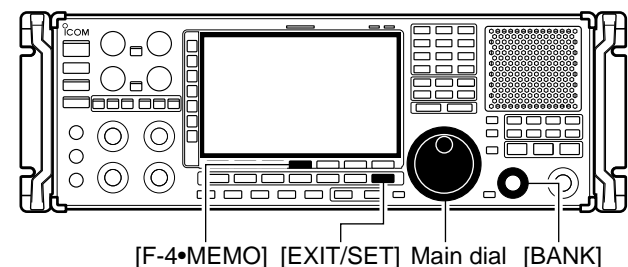

All memory channels (except skip channels) in the selected bank are scanned at up to 40 ch/sec.

- ① Push [EXIT/SET] several times to close a multifunction screen, if necessary.
- ② Push [F-5•SCAN] to select scan setting screen.
- ③ Push [F-4•MEMO] once to enter the bank selection.
- ④ Rotate the main dial to select the bank limit setting.
 - Selected bank number or OFF (Bank OFF) appears.
- ⑤ Or rotate [BANK] to select the other bank.
- ⑥ Push [F-4•MEMO], then rotate main dial to select the edge channel.
- ⑦ Push [F-4•MEMO], then rotate main dial to select the other edge channel.
- ⑧ Push [F-4•MEMO], then rotate main dial to select the desired select memory channel group for select memory scan.
 - ‘★1’ to ‘★9’ and ‘ALL’ are available.
- ⑨ Push [F-4•MEMO] to set the memory scan.

Memory scan operation

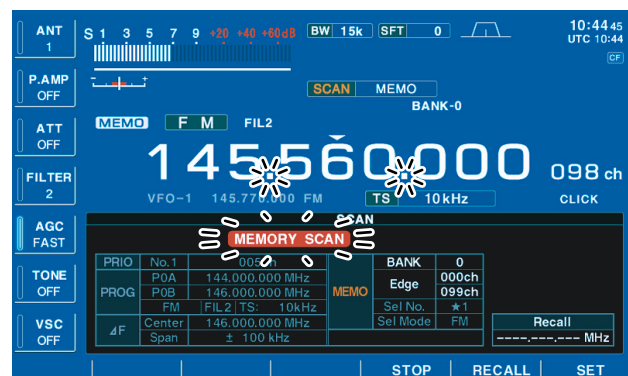
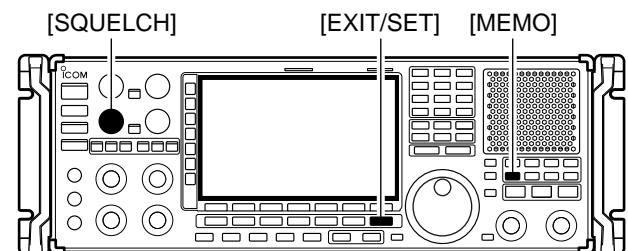

- ① Push [EXIT/SET] several times to close a multifunction screen, if necessary.
- ② Set the [SQUELCH] control open or closed.
 - See page 8-3 for squelch condition.
- ③ Push [MEMO] to start the memory scan.
 - Scan screen appears and memory mode is selected automatically.
 - “MEMORY SCAN” and decimal points blink during memory scan.
- ④ When the scan detects a signal, the scan stops, pauses or ignores it depending on the resume setting and the squelch condition.
- ⑤ To cancel the scan, push [MEMO].
 - Pushing [F5•STOP] also cancels the scan.
 - Pushing [EXIT/SET] closes the scan screen.

2 or more memory channels must be programmed for memory scan to start.

◇ Programming the select memory scan setting



• Memory-select window

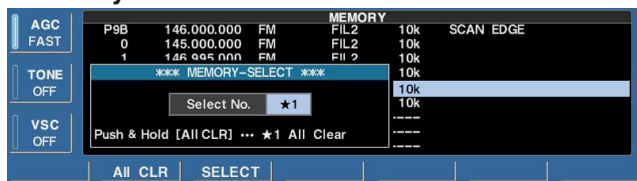

- ① Push [EXIT/SET] several times to close a multifunction screen, if necessary.
- ② Push [F-4•MEMORY] to select memory list screen.
- ③ While pushing and holding [F-1•ROLL] or [F-2•SET], rotate the main dial to select the desired memory channel.
 - [M-CH] (or [BANK]) control and direct keypad selection can be used.
- ④ Push and hold [F-3•SELECT] for 1 sec. to display the memory-select window.
- ⑤ Rotate the main dial to select the desired select memory channel group.
 - ★1 to ★9 are selectable.
- ⑥ Push [F-3•SELECT] to set the select setting ON.
 - Push [F-3•SELECT] again to select the select setting OFF.
- ⑦ Repeat steps ③ to ⑥ to program another memory channel as a select memory channel, if desired.
 - If you want to set a same select channel group, skip steps ④ and ⑤.
- ⑧ Push [EXIT/SET] to exit the memory list screen.

◇ Erasing the select scan setting

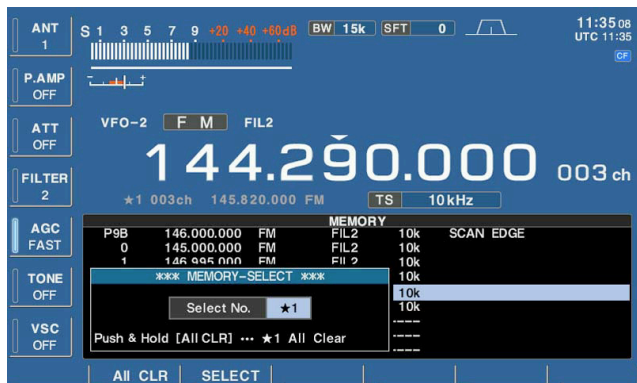

- ① Push [EXIT/SET] several times to close a multifunction screen, if necessary.
- ② Push [F-4•MEMORY] to select memory list screen.
- ③ Push and hold [F-3•SELECT] for 1 sec. to display memory-select window.
- ④ Rotate the main dial to select the desired select memory channel group to be erased.
- ⑤ Push and hold [F-2• ALL CLR] for 1 sec. to clear all select scan settings.
- ⑥ Push [EXIT/SET] to exit the memory list screen.

◇ Select memory scan operation

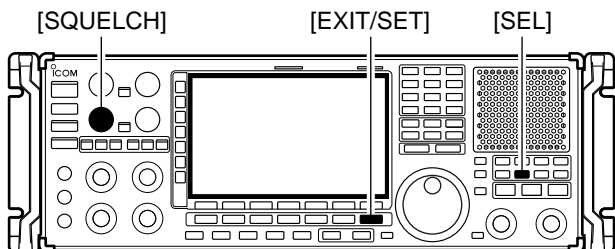

Scan indicator and select memory group number appear

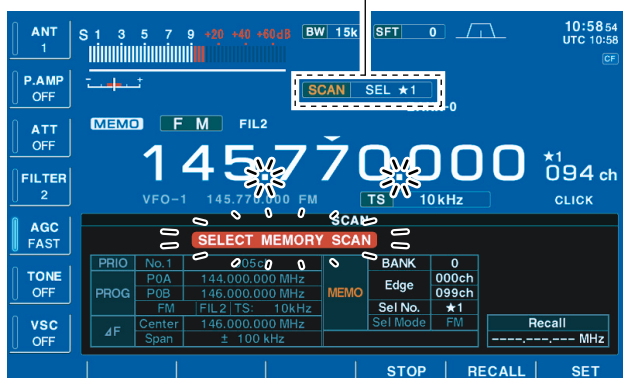

Select memory scan allows you to increase scan efficiency by searching for specified channels group only.

- ① Push [EXIT/SET] several times to close a multifunction screen, if necessary.
- ② Set the [SQUELCH] control open or closed.
 - See page 8-3 for squelch condition.
- ③ Push [SEL] to start the select memory scan.
 - Scan screen appears and memory mode is selected automatically.
 - “**SELECT MEMORY SCAN**” and decimal points blink during select memory scan.
 - Push numeral key (0–9) to change to the other groups.
- ④ When the scan detects a signal, the scan stops, pauses or ignores it depending on the resume setting and the squelch condition.
- ⑤ To cancel the scan, push [MEMO].
 - Pushing [F5•STOP] also cancels the scan.
 - Pushing [EXIT/SET] closes the scan screen.

2 or more memory channels must be designated as select memory channels, as well as the same select scan number, for select memory scan to start.

✓ For your convenience

Ten select memory scans can be selected directly from the keypad. Then the scan starts immediately.

➡ Push numeral key (0–9) then push [SEL] to start the desired select memory scan.

◇ Mode select memory scan operation

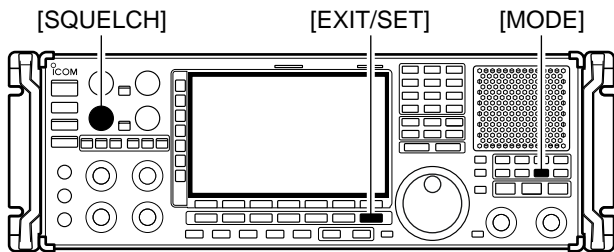

Scan indicator appears

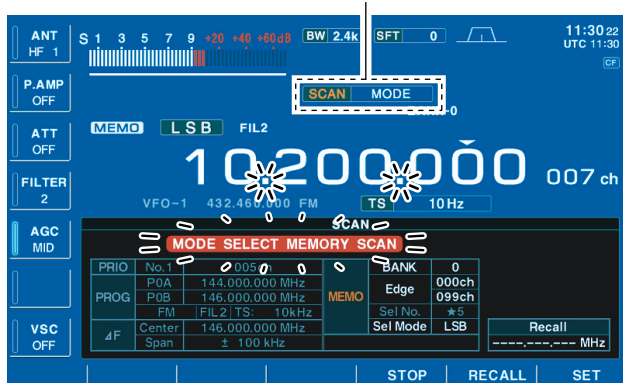

To operate memory scan in a specific mode (ignoring other modes), the mode select memory scan is available.

- ① Push [EXIT/SET] several times to close a multifunction screen, if necessary.
- ② Set the [SQUELCH] control open or closed.
 - See page 8-3 for squelch condition.
- ③ Select the desired operating mode.
 - The operating mode can also be changed while scanning.
- ④ Push [MODE] to start the mode select memory scan.
 - Scan screen appears and memory mode is selected automatically.
 - “**MODE SELECT MEMORY SCAN**” and decimal points blink during mode select memory scan.
- ⑤ When the scan detects a signal, the scan stops, pauses or ignores it depending on the resume setting and the squelch condition.
- ⑥ To cancel the scan, push [MODE].
 - Pushing [F5•STOP] also cancels the scan.
 - Pushing [EXIT/SET] closes the scan screen.

2 or more memory channels with same operating mode must be programmed for mode select memory scan to start.

■ Skip scan

You can set the selected memory channel as a skip channel which is skipped during memory scan. Its frequency is also skipped during programmed and auto memory write scans. This setting is useful to speed up the scan speed.

◇ Specifying skip channels

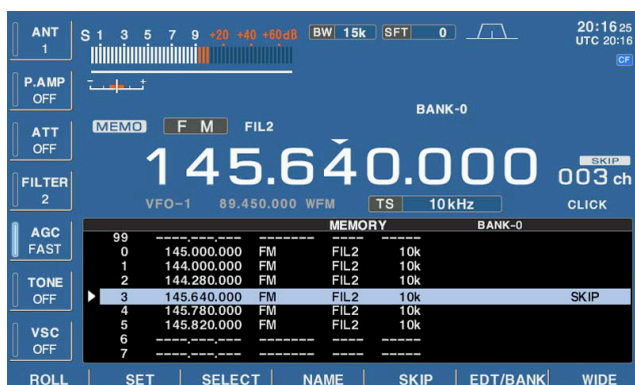

- ① Push [EXIT/SET] several times to close a multifunction screen, if necessary.
- ② Push [F-4•MEMORY] to select memory list screen.
- ③ While pushing and holding [F-1•ROLL] or [F-2•SET], rotate the main dial to select the memory channel to be specified as a skip channel.
 - [M-CH] (or [BANK]) control and direct keypad selection can be used.
- ④ Push [F-5•SKIP] to select the skip setting ON.
 - “SKIP” indicator appears.
 - Push [F-5•SKIP] again to select the skip setting OFF.
- ⑤ Repeat steps ③ to ④ to program another memory channel as a skip channel, if desired.
- ⑥ Push [EXIT/SET] to exit the memory list screen.

◇ Programming skip frequencies (for programming scan)

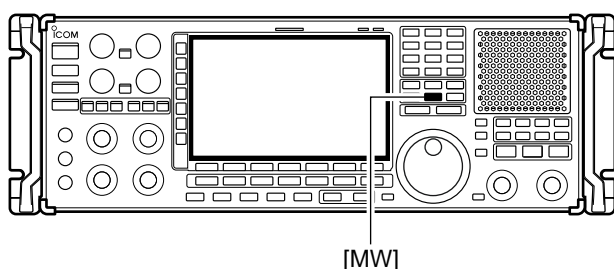

- ① Start programming scan as described on page 8-7.
- ② When the scan pauses on an undesired signal, push and hold [MW] for 1 sec.
 - The frequency is memorized into the skip bank as a skip frequency.

◇ Skip scan setting

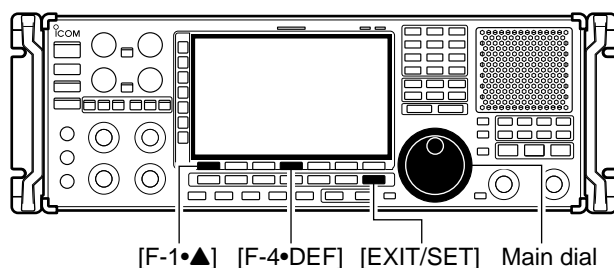

- ① Push [F-5•SCAN] to select scan screen.
- ② Push [F-7•SET] to select scan set mode.
- ③ Push [F-1•▲] to select “SKIP Function.”
- ④ Rotate the main dial to select the desired condition.
 - Push and hold [F-4•DEF] for 1 sec. to select the default setting.
- ⑤ Push [EXIT/SET] to return to scan menu.

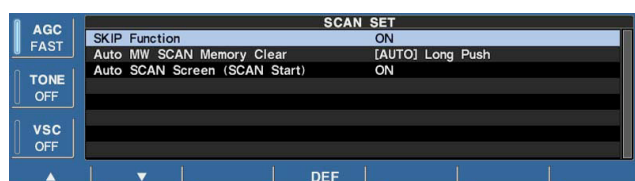

■ Tone scan

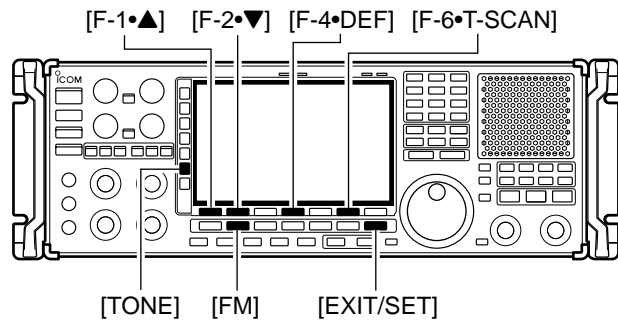

The receiver can detect subaudible tones or the DTCS code in a received signal. By monitoring a signal that is being operated with tone or DTCS squelch function, you can determine the tone frequency or DTCS code necessary to open a squelch.

- ① Set the desired frequency or memory channel to be checked for a tone frequency.
- ② Push [FM] to select FM mode.
- ③ Push and hold [TONE] for 1 sec. to enter tone frequency screen.
- ④ Push [F-1•▲] or [F-2•▼] to check the tone squelch frequency or DTCS code, respectively.
- ⑤ Push [F-6•T-SCAN] to start the tone scan.
 - "SCAN" blinks while scanning.
- ⑥ When the tone frequency is detected, the tone scan pauses.
 - The tone frequency is set temporarily on a memory channel. Program into the memory channel to store the tone frequency permanently.
 - The decoded tone frequency is used for the tone squelch frequency or DTCS squelch code.
- ⑦ To stop the scan, push [F-6•T-SCAN].
 - Push and hold [F-4•DEF] for 1 sec. to select the default frequency.
- ⑧ Push [EXIT/SET] to exit tone frequency screen.

■ Scan resume condition

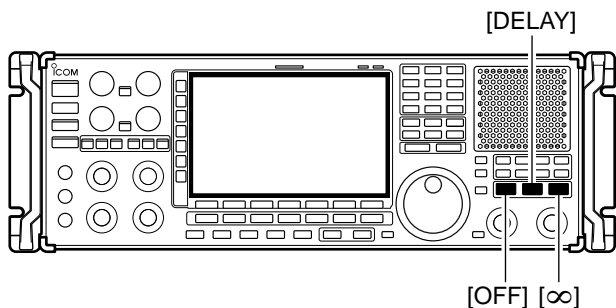

Scan pauses when finding a signal, and then resumes or is cancelled depending on the selected scan resume condition. There are 3 resume conditions.

• Scan resume OFF

Scan pauses until signal disappears, then resumes after 2 sec.

- ➔ Push [OFF] to set the scan pause timer to OFF.
- Scan resume indicator above this switch lights green.

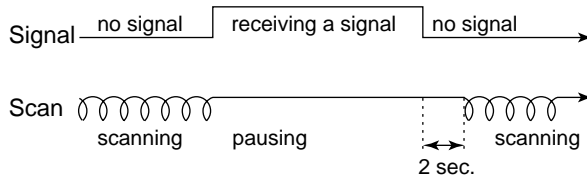

• Scan resume ON with specified time period

Scan pauses for the adjusted delay period after receiving a signal, then resumes. When the received signal disappears, scan resumes after 2 to 20 sec.

- ➔ Push [DELAY] to set the scan pause timer to specified time period according to [DELAY] control. (See next page for setting scan delay.)
- Scan resume indicator above this switch lights green.
- Scan delay time can be set 2 to 20 sec.

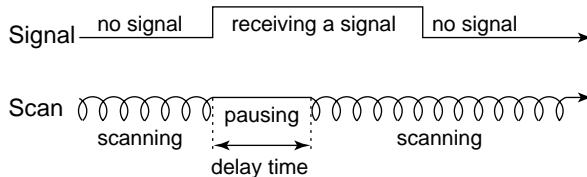

• Scan cancel

Scan is cancelled when a signal is found during scan.

- ➔ Push [∞] to set the scan pause timer to infinity (scan cancel).
- Scan resume indicator above this switch lights green.

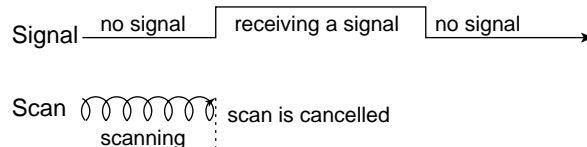

■ Scan speed

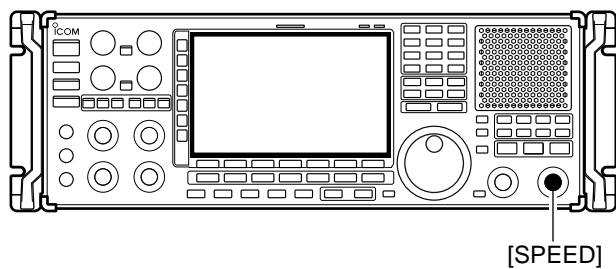

➡ Rotate [SPEED] to adjust the scan speed.

■ Scan delay

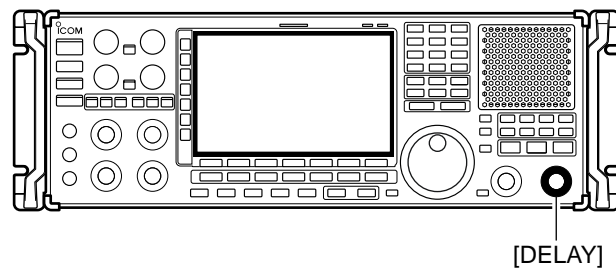

➡ Rotate [DELAY] to adjust the scan pause time when the scan resume setting is set to 'DELAY.'

- Scan delay time can be set 2 to 20 sec.

■ Voice synthesizer operation	9-2
■ Lock function	9-2
◇ Dial lock function	9-2
◇ Panel lock function	9-2
■ Dial click function	9-3
■ Antenna selection	9-3

■ Voice synthesizer operation

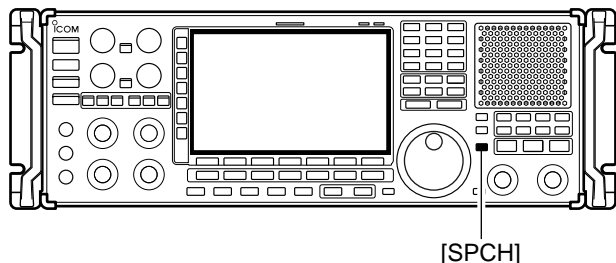

The IC-R9500 has a built-in voice synthesizer to announce the frequency, mode, etc. (S-meter level can also be announced—p. 11-10) in clear, electronically-generated voice, in English (or Japanese).

- ➔ Push [SPCH] to announce the currently selected frequency, etc.
 - Push [SPCH] for 1 sec. to additionally announce the selected mode.
 - ➔ Pushing a mode switch also announces the appropriate mode. (p. 11-11)
- ▨ The output level of the voice synthesizer can be adjusted in level set mode. (p. 11-6)

■ Lock function

The IC-R9500 has two kinds of lock functions: dial lock and panel lock. The dial lock function locks only the main dial, and panel lock function locks all front panel operation.

◇ Dial lock function

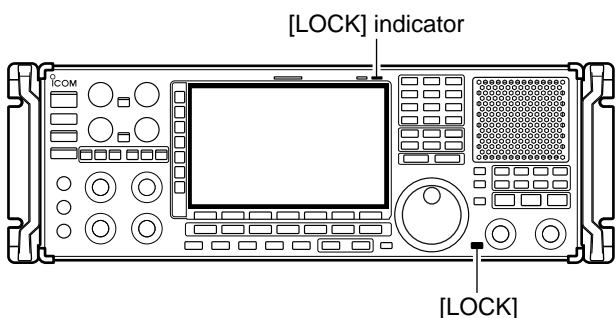

The dial lock function prevents frequency changes by accidental movement of the tuning dial. The lock function electronically locks the dial.

- ➔ Push [LOCK] to toggle the dial lock function ON or OFF.
 - The [LOCK] indicator lights orange when the dial lock function is in use.

◇ Panel lock function

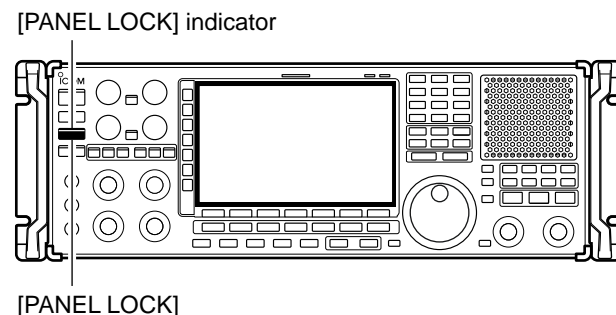

To prevent accidental frequency changes and unnecessary function access, use the panel lock function. This function is also available with display sleep mode

- ➔ Push [PANEL LOCK] to toggle the panel lock function ON or OFF.
 - The [PANEL LOCK] indicator lights green when the panel lock function is in use.
- ➔ Push and hold [PANEL LOCK] for 1 sec. to turn the panel lock with display sleep function ON.
 - Pushing [PANEL LOCK] turns this function OFF.
 - The [PANEL LOCK] indicator lights green and the display turns OFF when the sleep function is in use.

▨ The audio controls or any other controls can be used depending on "[PANEL LOCK] SWITCH" setting in others set mode (p. 11-10) while function ON.

■ Dial click function

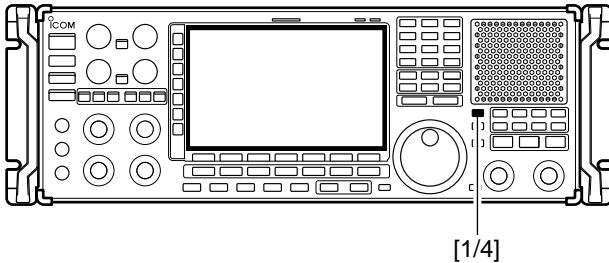

The IC-R9500 can turn the dial click function ON and OFF. And the auto dial click setting is also available in the others set mode (p. 11-12).

- ➔ Push and hold [1/4] for 1 sec. to turn the dial click function ON and OFF manually.
 - “CLICK” appears.

■ Antenna selection

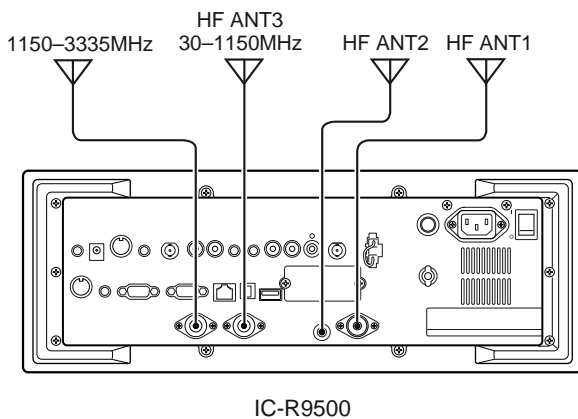

The IC-R9500 has 3 antenna connectors for bands below 30 MHz which are [HF ANT1], [HF ANT2] and [ANT1/HF ANT3]. And antenna control voltage is also output from [ANT SEL] connector for using external preamplifier or antenna selector.

For each operating band the IC-R9500 covers, there is a band memory which can memorize a selected antenna. When you change the operating frequency beyond a band, the previously used antenna is automatically selected (see left) for the new band. This function allows automatic switching of 3 separate antennas for HF bands operation.

After an antenna has been selected for use (by pushing [ANT]), the antenna is automatically selected whenever that band is used.

[EXAMPLE]: a 3.5/7 MHz antenna is connected to [HF ANT1], a 14/18 MHz antenna is connected to [HF ANT2], a 24/28 MHz antenna is connected to [HF ANT3]. After each antenna is selected, an antenna is automatically selected when changing bands.

• Antenna selection

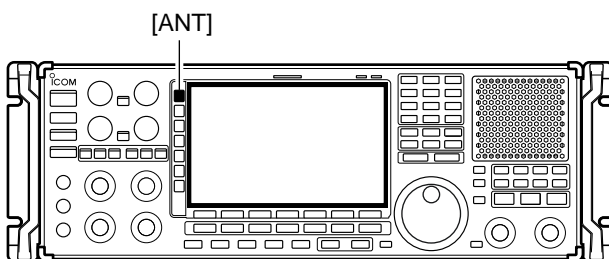

- ➔ Push [ANT] to select the antenna from “ANT HF 1,” “ANT HF 2” and “ANT HF 3.”
 - The antenna indicator turns ON when other than default antenna (ANT1) is selected.
- ➔ Push and hold [ANT] for 1 sec to turn the antenna control voltage ON and OFF from [ANT SEL] connector.
 - When it's ON, “★” appears. Then the receiver output 13.8 V/100 mA max. from [ANT SEL] connector.

■ Time set mode	10-2
■ Daily timer setting	10-3
■ Setting sleep timer	10-4
■ Timer operation	10-4

Time set mode

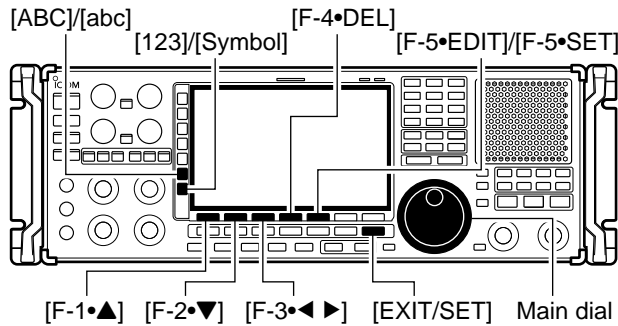

The IC-R9500 has a built-in calendar and 24-hour clock with daily power ON/OFF timer functions. Before operating these timer functions, set the current date and time.

- ① Push [EXIT/SET] to close multifunction screen, if necessary.
- ② Push [F-7•SET] to select set mode menu screen.
- ③ Push [F-4•TIME] to select time set mode.
- ④ Push [F-1•▲] or [F-2•▼] to select the desired item.
- ⑤ Rotate the main dial to set or select the desired value or condition.
- ⑥ Push [EXIT/SET] to exit time set mode.

Date	2000 - 1 - 1 (Sat)
Sets the date.	<ol style="list-style-type: none"> ① Push [F-3•◀▶] to select between the year and the month/day, then rotate the main dial to select them. <ul style="list-style-type: none"> • The date setting and “DATE-set Push [SET]” indication blink. ② Push [F-5•SET] to set the date.

Time (Now)	1:23
Sets the local time.	<ol style="list-style-type: none"> ① Rotate the main dial to set the local time. <ul style="list-style-type: none"> • The time setting and “TIME-set Push [SET]” indication blink. ② Push [F-5•SET] to set the time.

CLOCK2 Function	ON
Turns the clock 2 display ON and OFF. The clock 2 is convenient to indicate UTC or another country’s local time, etc.	<ul style="list-style-type: none"> • ON : Clock 2 is displayed below the local time display. • OFF : The clock 2 is not displayed.

CLOCK2 Offset	± 0:00
Sets the desired offset time period for clock 2 within -24:00 to +24:00 in 5 min. steps.	<ul style="list-style-type: none"> • Push and hold [F-4•DEF] for 1 sec. to select the default value.

CLOCK2 Name	UTC
Sets the desired 3-character name for clock 2. Capital letters, small letters, numerals, some symbols (!# \$ % & ¥ ? " ' ` ^ + - * / . , ; = < > () [] { } _ ~ @) and spaces can be used.	<ol style="list-style-type: none"> ① Push [F-5•EDIT] to select the name edit condition. <ul style="list-style-type: none"> • The cursor under the 1st character blinks. ② Push [ABC], [abc], [123] or [Symbol] to select the character group, then rotate the main dial to select the character. <ul style="list-style-type: none"> • Push [ABC] or [abc] to toggle capital and small letters. • Push [123] or [Symbol] to toggle numerals and symbols. • Push [F-1•◀] or [F-2•▶] for cursor movement. • Push [F-3•DEL] to delete the selected character. • Push [F-4•SPACE] to input a space. • Using the receiver’s keypad, [0]–[9], can also enter numerals. ③ Push [EXIT/SET] to set the name.

■ Daily timer setting

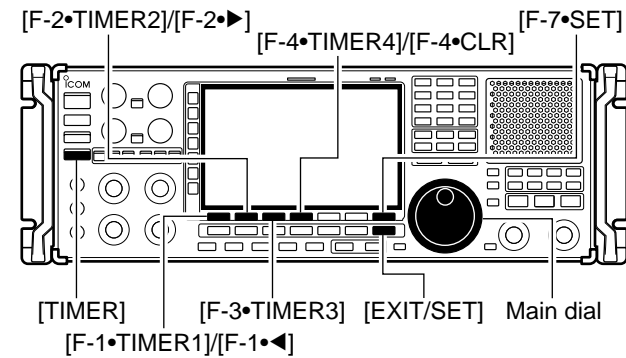

AGC MID		DAILY TIMER						TIMER	
		ACT	DAY	REPEAT	ON	OFF	Mch		
		TIMER1	OFF	---	OFF	0:00	---		
		TIMER2	OFF	---	OFF	0:00	---		
		TIMER3	OFF	---	OFF	0:00	---		
		TIMER4	OFF	---	OFF	0:00	---		
		TIMER5	OFF	---	OFF	0:00	---		
		2006-12-18(Mon) 12:03						SLEEP	
								--- min	
VSC OFF		TIMER1	TIMER2	TIMER3	TIMER4	TIMER5	SLEEP		

The receiver turns power ON and/or OFF automatically at the specified day and time, with the specified frequency settings.

- ① Push [EXIT/SET] several times to close multifunction screen, if necessary.
- ② Push [TIMER] for 1 sec. to select timer set screen.
- ③ Push one of [F-1•TIMER1] to [F-5•TIMER5] to select the desired timer.
- ④ Rotate the main dial to select the timer action ON and OFF.
- ⑤ Push [F-2•▶] to select the “DAY” cell, then rotate the main dial to select the desired day of the week.
 - Select “---” not to specify daily operation and activate the timer every day.
 - Once a day of the week is selected, push [F-4•CLR] for 1 sec. to select “---.”
- ⑥ Push [F-2•▶] to select the “REPEAT” cell, then rotate the main dial to select the repeat function ON or OFF.
 - ON : The timer functions every selected day of the week. (repeats)
 - OFF : The timer does not repeat.
- ⑦ Push [F-2•▶] to select the “ON” cell, then rotate the main dial to set the desired receiver power ON time.
 - When using power OFF timer only, push [F-4•CLR] for 1 sec. to select “---.”
- ⑧ Push [F-2•▶] to select the “OFF” cell, then rotate the main dial to set the desired receiver power OFF time.
 - When using power ON timer only, push [F-4•CLR] for 1 sec. to select “---.”
- ⑨ Push [F-2•▶] to select the “Mch” cell, then rotate the main dial to select the desired memory channel number in the main readout.
 - If using the currently set VFO condition in main readout, push [F-4•CLR] for 1 sec. to select “---.”
- ⑩ Push [F-7•SET] to set the timer.
 - The timer indicator above [TIMER] switch lights green.
- ⑪ Repeat steps ③ to ⑩ to set other timers, if desired.
- ⑫ Push [EXIT/SET] to exit timer set screen.

■ Setting sleep timer

The sleep timer turns the receiver power OFF automatically after a set period. The timer can be set to 5–120 min. in 5 min. steps.

▨ The sleep timer function counts the ‘minute’ unit, and does not count the ‘second’ unit. For example, when the sleep timer is started at 12:00 59, first one minute past for just 1 sec. That is way it has max. 59 sec. an error. This is normal, not a malfunction.

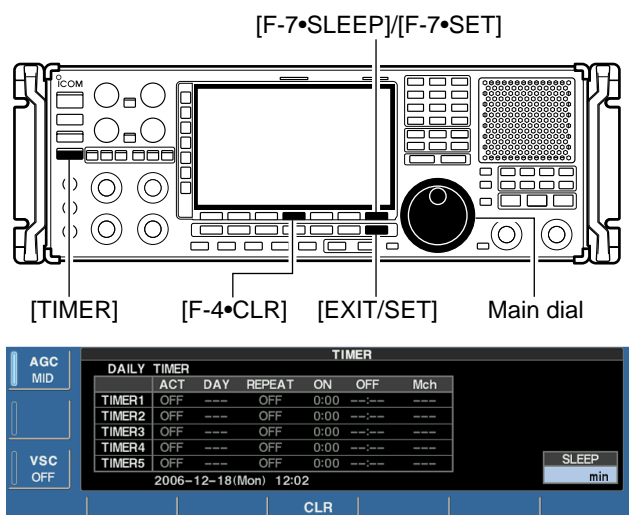

- ① Push [EXIT/SET] several times to close a multifunction screen, if necessary.
- ② Push [TIMER] for 1 sec. to select timer set screen.
- ③ Push [F-7•SLEEP] to select the sleep timer set condition.
 - “---” blinks.
- ④ Set the desired time period using the main dial.
 - “TIMER-set Push [SET]” blinks.
 - Push [F-4•CLR] to select “---” to cancel the setting.
- ⑤ Push [F-7•SET] to set the time.
 - Push [EXIT/SET] to cancel the setting.
 - The timer indicator above [TIMER] switch lights green.
- ⑥ Push [EXIT/SET] to exit timer set screen.
- ⑦ The receiver emits 10 beeps and turns OFF after the sleep timer period elapses.
 - The timer indicator blinks while beeping.
 - Push [TIMER] momentarily to cancel the sleep timer, if desired.

■ Timer operation

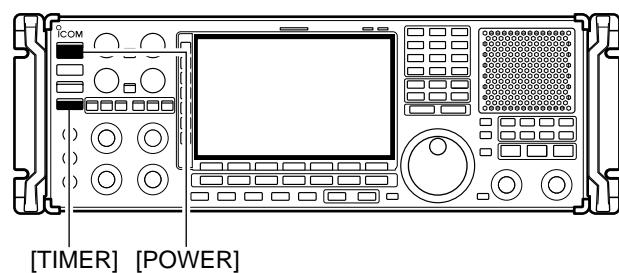

- ① Preset the daily timer as described previously.
- ② Push [TIMER] momentarily to turn the timer function ON.
 - The timer indicator above this switch lights green when the timer function is ON.
- ③ Push and hold [POWER] for 1 sec. to turn the power OFF.
 - The timer indicator lights continuously.
- ④ When the set time arrives, the power is automatically turned ON.
- ⑤ The receiver emits 10 beeps and turns OFF after the power-off period elapses.
 - The timer indicator blinks while beeping.
 - Push [TIMER] momentarily to cancel the sleep timer, if desired.

▨ The timer action in timer set screen must be turned ON to enable the timer operation, described above “Setting sleep timer” steps ④.

■ Set mode description	11-2
◇ Set mode operation	11-2
◇ Screen arrangement	11-3
■ Level set mode	11-4
■ ACC set mode	11-7
■ Display set mode	11-8
■ Others set mode	11-10
■ CF card/USB-Memory set menu	11-16
◇ CF/USB-Memory set screen arrangement	11-16
◇ Load option set mode	11-17
■ File saving	11-18
■ File loading	11-19
■ Changing the file name	11-20
■ File copying	11-21
■ Deleting a file	11-22
■ Unmount an USB-Memory	11-22
■ Formatting the CF card or USB-Memory	11-23
■ Display set (Video) mode	11-24
■ LCD set mode	11-26

■ Set mode description

Set mode is used for programming infrequently changed values or conditions of functions. The IC-R9500 has a level set mode, display set mode, timer set mode, accessory set mode, others set mode and CF/USB-Memory set mode.

◇ Set mode operation

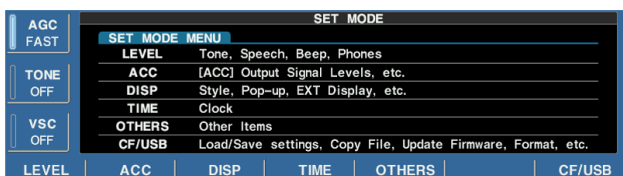
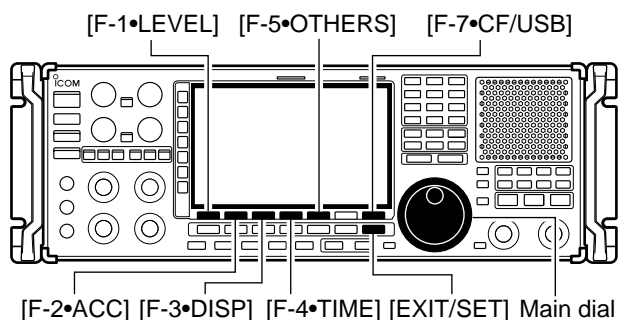

- ① Push [EXIT/SET] several times to close a multi-function screen, if necessary.
- ② Push [F-7•SET] to select set mode menu screen.
 - Pushing and holding [EXIT/SET] for 1 sec. also selects set mode menu screen.
- ③ Push [F-1•LEVEL], [F-2•ACC], [F-3•DISP], [F-4•TIME], [F-5•OTHERS] or [F-7•CF/USB] to enter the desired set mode.
- ④ For level, accessory, display and others set mode, push [F-7•WIDE] to toggle wide and normal screen.
- ⑤ Push [F-1•▲] or [F-2•▼] to select the desired item, then rotate main dial to adjust/select the desired value or condition.
 - Pushing [F-3•◀ ▶] operation may be necessary for some items.
- ⑥ Push [EXIT/SET] twice to exit set mode.

◇ Screen arrangement



• Display set mode (p. 11-8)

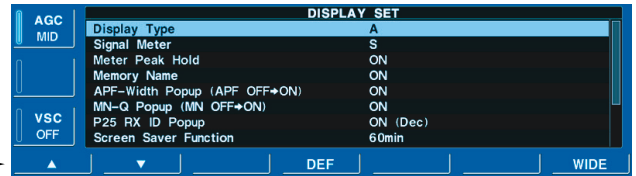

• Set mode menu screen (p. 11-2)

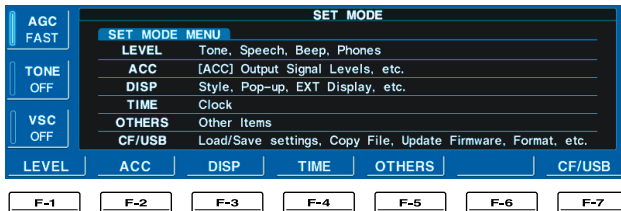

• Time set mode (p. 10-2)



• Level set mode (p. 11-4)



• Others set mode (p. 11-10)

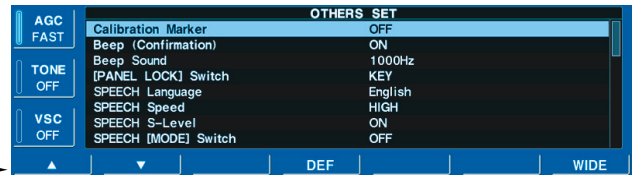

• ACC set mode (p. 11-7)

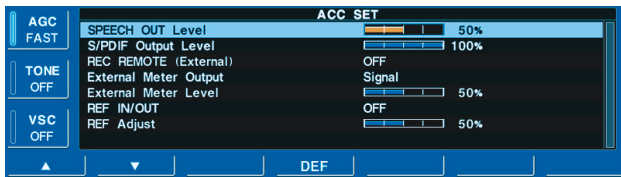

• CF/USB-Memory set menu (p. 11-16)

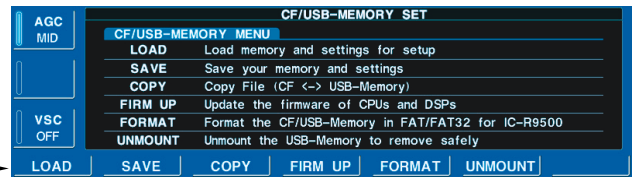

F-2 F-7

■ Level set mode

FM Tone (Bass)  0

Sets the bass level of the receive audio in FM mode from -15 to +15. (default: 0)

FM Tone (Treble)  0

Sets the treble level of the receive audio in FM mode from -15 to +15. (default: 0)

WFM Tone (Bass)  0

Sets the bass level of the receive audio in WFM mode from -15 to +15. (default: 0)

WFM Tone (Treble)  0

Sets the treble level of the receive audio in WFM mode from -15 to +15. (default: 0)

AM Tone (Bass)  0

Sets the bass level of the receive audio in AM mode from -15 to +15. (default: 0)

AM Tone (Treble)  0

Sets the treble level of the receive audio in AM mode from -15 to +15. (default: 0)

SSB Tone (Bass)  0

Sets the bass level of the receive audio in SSB mode from -15 to +15. (default: 0)

SSB Tone (Treble)  0

Sets the treble level of the receive audio in SSB mode from -15 to +15. (default: 0)

CW Tone (Bass)  0

Sets the bass level of the receive audio in CW mode from -15 to +15. (default: 0)

CW Tone (Treble)  0

Sets the treble level of the receive audio in CW mode from -15 to +15. (default: 0)

■ Level set mode (continued)

FSK Tone (Bass)



0

Sets the bass level of the receive audio in FSK mode from -15 to +15. (default: 0)

FSK Tone (Treble)



0

Sets the treble level of the receive audio in FSK mode from -15 to +15. (default: 0)

De-Emphasis (FM 50k)

OFF

De-emphasis is the use of an amplitude-frequency characteristic complimentary to the one used for pre-emphasis prior to transmission.

Sets the de-emphasis circuit ON and OFF when the 50 kHz width filter is used in FM mode. (default: OFF)

(FM 15k)

ON

Sets the de-emphasis circuit ON and OFF when the 15 kHz width filter is used in FM mode. (default: ON)

(FM 7k)

ON

Sets the de-emphasis circuit ON and OFF when the 7 kHz width filter is used in FM mode. (default: ON)

AF High Cut (FM 50k)

OFF

Sets the AF high cut filter circuit ON and OFF when the 50 kHz width filter is used in FM mode. (default: OFF)

(FM 15k)

ON

Sets the AF high cut filter circuit ON and OFF when the 15 kHz width filter is used in FM mode. (default: ON)

(FM 7k)

ON

Sets the AF high cut filter circuit ON and OFF when the 7 kHz width filter is used in FM mode. (default: ON)

(WFM)

OFF

Sets the AF high cut filter circuit ON and OFF in WFM mode. (default: OFF)

■ Level set mode (continued)

(AM)	OFF
Turns the AF high cut filter circuit ON and OFF in AM mode. (default: OFF)	

(SSB)	ON
Turns the AF high cut filter circuit ON and OFF in SSB mode. (default: ON)	

(CW)	ON
Turns the AF high cut filter circuit ON and OFF in CW mode. (default: ON)	

(FSK)	ON
Turns the AF high cut filter circuit ON and OFF in FSK mode. (default: ON)	

(P25)	ON
Turns the AF high cut filter circuit ON and OFF in P25 mode. (default: ON)	

Speech Level	 50%
Sets the voice synthesizer audio output level from 0 to 100% in 1% steps. (default: 50%)	

Beep Level	 50%
Sets the key-touch beep output level from 0 to 100% in 1% steps. (default: 50%)	

Beep Level Limit	ON
Turns the key-touch beep output level limiting capability from ON and OFF. (default: ON)	

Phones Level Ratio	1.00
Sets the ratio for audio output level from the headphone to the internal speaker from 0.60 to 1.40 range in 0.01 steps. (default: 1.00)	

■ ACC set mode

SPEECH OUT Level		50%
<p>Sets the speech audio output level from [SPEECH OUT] from 0 to 100% in 1% steps.</p> <ul style="list-style-type: none"> • Outputs approx. 200 mV at 50% (default) setting. 		

S/PDIF Output Level		100%
<p>Sets the desired output level of [S/P DIF OUT], from 0 to 100% in 1% steps. (default: 100%)</p>		

REC Remote (External)	OFF
<p>Turns the control signal of external equipment output capability ON and OFF. (default: OFF)</p>	<ul style="list-style-type: none"> • OFF : No signal output from [REC REMOTE] jacks. (default) • ON : The [REC REMOTE] jacks shorts to ground when receiving a signal or the squelch is open.

External Meter Output	Signal
<p>Selects the squelch condition output for an external meter indication from pin 8 of [ACC].</p>	<ul style="list-style-type: none"> • Signal : Outputs the receiving signal strength level during receiving. (default) • Signal+SQL: Outputs the receiving signal strength level during receiving and outputs squelch open/close condition.

External Meter Level		50%
<p>Sets the output level for an external meter indication from 0 to 100% range in 1% steps.</p>	<ul style="list-style-type: none"> • Approx. 2.5 V at 50% (default) setting for full-scale indication. (4.7 kΩ impedance) 	

Reference IN/OUT	OFF
<p>Selects the receiver's reference signal condition from IN, OFF and OUT.</p>	<ul style="list-style-type: none"> • IN : Use an external reference signal for the IC-R9500. • OFF : No input or output of the reference signal. (default) • OUT : Outputs the IC-R9500 reference signal to externally connected equipment(s) for their reference. <p>/// NOTE: If the applied reference signal is off-frequency, or no signal is applied with "IN" selection, the IC-R9500 will not work properly. Select "OFF" or "OUT" then reboot the IC-R9500.</p>

REF Adjust		40%
<p>Adjusts the internal reference frequency within 0 to 100% in 1% steps during frequency calibration.</p>	<p>/// NOTE: Default setting is different for each receiver.</p>	

■ Display set mode

NOTE: “Display set (Video) mode” is described on page 11-24.

Display Type		A
Selects the desired display type from A and B. (default: A)		
Signal Meter		S
Selects the desired signal meter type from “S,” “dBμ,” “dBμ[EMF]” and “dBm.” (default: S)		
Meter Peak Hold		ON
Turns the meter peak hold function ON or OFF. (default: ON) This function is used for the bar meter only.		
Memory Name		ON
Sets the memory name indication, during memory mode operation, ON and OFF. (default: ON)	<ul style="list-style-type: none"> • ON : The programmed memory name is displayed above the frequency indication. • OFF : No memory name is displayed even a memory name is programmed. 	
APF-Width Popup (APF OFF→ON)		ON
Selects the pop-up indication of the APF filter width ON and OFF when the APF function is turned ON. (default: ON)		
MN-Q Popup (MN OFF→ON)		ON
Selects the pop-up indication of the notch filter width ON and OFF when the notch filter is turned ON. (default: ON)		
P25 RX ID Popup		ON (Dec)
Sets the pop-up indication of the received ID in P25 mode ON and OFF. (default: ON)	<ul style="list-style-type: none"> • ON (Hex): The received ID code (hexadecimal indication) is displayed when an ID code is received. • ON (Dec): The received ID code (decimal indication) is displayed when an ID code is received. (default) • OFF : No ID code is displayed when an ID code is received. 	
Screen Saver Function		60min
Turns the screen saver function ON (15, 30 or 60 minutes) and OFF. (default: 60 min.)	The screen saver will activate when no operation is performed for the selected time period to protect the LCD from “burn-in.”	

■ Display set mode (continued)

External Display	OFF
Select "ON" when the external display is connected. (default: OFF)	<ul style="list-style-type: none"> • At least 800×600 pixel resolution is required for the display.
External Display Sync Pulse	H
Selects the suitable pulse level for the connected external display from H and L. (default: H)	
Opening Message	ON
Turns the opening message screen indication capability ON and OFF. (default: ON)	
Opening Comment	
Sets the introductory text, up to 10-character long, displayed in the opening screen.	
Capital letters, small letters, numerals, some symbols (– / . @) and spaces can be used.	<ol style="list-style-type: none"> 1 Push [F-5•EDIT] to select the comment edit condition. <ul style="list-style-type: none"> • The cursor under the 1st character blinks. 2 Push [ABC], [abc], [123] or [Symbol] to select the character group, then rotate the main dial to select the character. <ul style="list-style-type: none"> • Push [ABC] or [abc] to toggle capital and small letters. • Push [123] or [Symbol] to toggle numerals and symbols. • Push [F-1•◀] or [F-2•▶] for cursor movement. • Push [F-3•DEL] to delete the selected character. • Push [F-4•SPACE] to input a space. • Using the receiver's keypad, [0]–[9], can also enter numerals. 3 Push [EXIT/SET] to set the comment.

Others set mode

Calibration Marker	OFF
<p>This item is used for a simple frequency check of the receiver. (default: OFF) See p. 12-5 for calibration procedure.</p> <p>NOTE: Turn the calibration marker OFF after checking the frequency of the receiver.</p>	

Beep (Confirmation)	ON
<p>A beep sounds each time a switch is pushed to confirm it. This function can be turned OFF for silent operation. (default: ON)</p> <p>The beep output level can be set in level set mode. (p. 11-6)</p>	

Beep Sound	1000Hz
<p>Sets the desired key-touch beep sound frequency from 500 to 2000 Hz in 10 Hz steps. (default: 1000 Hz)</p>	

[PANEL LOCK] SWITCH	ALL
<p>Selects the Panel lock function activity from “ALL” and “KEY.” (default: ALL)</p>	<p>ALL : All dials, keys and switches are locked when function ON.</p> <p>KEY : Following controller are active when function ON. [TWIN PBT], [SQUELCH], [AGC], [NOTCH], [NB LEVEL], [NR LEVEL], [AF], [RF], [TREBLE] and [BASS] controls</p>

SPEECH Language	English
<p>Selects the speech language from English and Japanese. (default: English)</p>	

SPEECH Speed	High
<p>Selects the speech speed from HIGH (faster) and LOW (slower). (default: HIGH)</p>	

SPEECH S-Level	ON
<p>The IC-R9500 speech processor has frequency, mode and signal level announcement. Signal level announcement can be deactivated if desired. (default: ON)</p> <p>When “OFF” is selected, the signal level is not announced.</p>	

■ Others set mode (continued)

SPEECH [MODE] SWITCH	OFF
<p>Selects the operating mode speech capability when a mode switch is pushed; ON or OFF. (default: OFF)</p> <p>When “ON” is selected, the selected operating mode is announced when a mode switch is pushed.</p>	

REC SPEECH	OFF
<p>Selects the frequency speech capability when scan stops; ON or OFF.</p> <ul style="list-style-type: none"> • ON : The frequency is announced through the [REC OUT]/[LINE OUT] or [SPEECH OUT] when scan stops. • OFF : No speech audio outputs when scan stops. <p>/// NOTE: Output jacks are selected depending on “SPEECH Mix” settings. See the combination of “REC SPEECH” and “SPEECH Mix” settings in the table below.</p>	

SPEECH Mix	All
<p>Selects the speech audio output from the [REC OUT] or [LINE OUT].</p> <ul style="list-style-type: none"> • All : Outputs the speech audio when speech operation is performed from the front panel or depends on above “REC SPEECH” setting. (default) • Operation: Outputs the speech audio when speech operation is performed from the front panel. • OFF : No speech audio outputs from [REC OUT] or [LINE OUT]. <p>/// NOTE: See the combination of “REC SPEECH” and “SPEECH Mix” settings below table.</p>	

• Combination of REC SPEECH and SPEECH Mix settings

Switch setting		Speech operation from front panel			Scan stops		
REC SPEECH	SPEECH Mix	Internal Speaker	[REC OUT] / [LINE OUT]	[SPEECH OUT]	Internal Speaker	[REC OUT] / [LINE OUT]	[SPEECH OUT]
OFF	All	✓	✓	✓	–	–	–
	Operation	✓	✓	✓	–	–	–
	OFF	–	–	✓	–	–	–
ON	All	✓	✓	✓	✓	✓	✓
	Operation	✓	✓	✓	✓	–	✓
	OFF	–	–	✓	–	–	✓

Others set mode (continued)

MAIN DIAL Auto TS	High
<p>Sets the auto tuning step function for the main dial. When rotating the main dial rapidly, the tuning step automatically changes several times as selected.</p> <p>There are 2 type of auto tuning steps: HIGH (Fastest) and LOW (Faster). (default: HIGH)</p>	<ul style="list-style-type: none"> • HIGH : Auto tuning step is turned ON. Fastest tuning step during rapid rotation. (default) • LOW : Auto tuning step is turned ON. Faster tuning step during rapid rotation. • OFF : Auto tuning step is turned OFF.

MAIN DIAL Click Mode	Auto
<p>Sets the dial click function for the main dial from Auto or Manual.</p>	<ul style="list-style-type: none"> • Auto : Sets the dial click function automatically when a tuning step is set higher than 5 kHz or changing the set mode contents, etc. (default) • Manual : Sets the dial click function manually. <p>/// NOTE: When “Manual” is selected, set the next item “MAIN DIAL CLICK” ON or OFF.</p>

MAIN DIAL Click	Auto
<p>Sets the dial click function ON or OFF. This item can be set when the previous item “MAIN DIAL Click Mode” is set to “Manual.”</p> <p>/// NOTE: When the previous item is set to “Auto,” this item is fixed “Auto.”</p>	<ul style="list-style-type: none"> • Auto : Selection can not be changed, set the previous item to “Manual” in advance. (default) • ON : The dial click function is ON, “CLICK” indicator appears on the display. • OFF : The dial click function is OFF.

MAIN DIAL Click (Set mode, etc)	ON
<p>Selects the dial click function while setting the set mode items, etc. from ON and OFF. (default: ON)</p>	<ul style="list-style-type: none"> • ON : The main dial click function is ON. • OFF : The main dial click function is OFF.

MAIN DIAL Operation (SCAN)	Up/Down
<p>Selects the main dial function while scanning from OFF and Up/Down. (default: Up/Down)</p>	<ul style="list-style-type: none"> • OFF : The main dial stops scan. • Up/Down : The main dial changes scanning direction Up or Down.

AFC Limit	ON
<p>The AFC function automatically compensates the tuning when a received frequency drifts or goes off frequency.</p> <p>This item sets the AFC limit function ON and OFF.</p>	<ul style="list-style-type: none"> • ON : AFC function stops to tune when frequency goes off the limited frequency range even if received frequency is off frequency. (default) • OFF : AFC function continues to tune until displayed frequency changes to reflect the center of the signal.

■ Others set mode (continued)

SSB/CW Synchronous Tuning

OFF

Selects the displayed frequency shift function from ON and OFF. (default: OFF)

When this function is activated, the received signal will continue to be received even when the operating mode is changed between SSB and CW.

/// The frequency shifting value may differ according to the CW pitch setting.

- ON : The displayed frequency shifts when the operating mode is changed between SSB and CW.
- OFF : The displayed frequency does not shift.

CW Normal Side

LSB

Selects the side band used to receive CW in CW normal mode. (default: LSB)

APF Type

SOFT

Sets audio filter shape for APF from SOFT and SHARP. (default : SOFT).

- SOFT : Soft filter shape makes distinguishing noise and signals easier. The audio filter width is related to the CW pitch setting.
- SHARP : Sharp filter shape rejects interference signals. The audio filter width is fixed.

■ Others set mode (continued)

CI-V Baud Rate	Auto
<p>Sets the CI-V data transfer rate. 300, 1200, 4800, 9600, 19200 bps and “Auto” are available. (default: Auto)</p> <p>When “Auto” is selected, the baud rate is automatically set according to the data rate of connected controller.</p>	

CI-V Address	72h
<p>To distinguish equipment, each CI-V transceiver or receiver has its own Icom standard address in hexadecimal code. The IC-R9500’s address is 72h.</p> <p>When 2 or more IC-R9500’s are connected to an optional CT-17 CI-V LEVEL CONVERTER, rotate the main dial to select a different address for each IC-R9500; the range is 01h to 7Fh.</p>	

CI-V Transceive	ON
<p>Transceive operation is possible with the IC-R9500 connected to other Icom transceivers or receivers.</p> <p>When “ON” is selected, changing the frequency, operating mode, etc. on the IC-R9500 automatically changes those of connected transceivers (or receivers) and vice versa.</p>	

RS-232C Function	CI-V
<p>Select [RS-232C] connector output data format from CI-V and Decode.</p>	<ul style="list-style-type: none"> • CI-V : Outputs data in CI-V format. (default) • Decode : Outputs decoded contents in ASCII code format.

Decode Baud Rate	9600
<p>Selects data transmission speed (Baud rate) when “Decode” is selected in “RS-232C Function” above; settings are 300, 1200, 4800, 9600 and 19200 bps. (default: 9600)</p>	

Keyboard Type	English
<p>Selects the connected keyboard type from Japanese, English, United Kingdom, French, French (Canadian), German, Portuguese, Portuguese (Brazilian), Spanish, Spanish (Latin American) and Italian. (default: English)</p>	

■ Others set mode (continued)

Keyboard Repeat Delay 250ms

Sets the time period for delay within 100 to 1000 msec. in 50 msec. steps. (default: 250 msec.)

When a key of the connected keyboard is pressed and held for the set period, the character is input continuously.

Keyboard Repeat Rate 10.9cps

Sets the repeating rate for the connected keyboard within 2.0 to 30.0 cps. (default: 10.9 cps)

*cps=character per second

When a key of the connected keyboard is pressed and held, the character is repeatedly input with the set speed.

• Available repeating rate

2.0, 2.1, 2.3, 2.5, 2.7, 3.0, 3.3, 3.7, 4.0, 4.3, 4.6, 5.0, 5.5, 6.0, 6.7, 7.5, 8.0, 8.6, 9.2, 10.0, 10.9, 12.0, 13.3, 15.0, 16.0, 17.1, 18.5, 20.0, 21.8, 24.0, 26.7, 30.0

IP Address (Valid after Reboot) 192.168. 0. 1

Sets IP address for the IC-R9500 when connecting to your PC or LAN (Local Area Network) through the Ethernet connector.

Turn the receiver power OFF then ON to make the setting effective. See p. 15-7 for details.

Subnet Mask (Valid after Reboot) 255.255.255. 0 (24bit)

Sets subnet mask for the IC-R9500 when connecting to your PC or LAN (Local Area Network) through the Ethernet connector.

Turn the receiver power OFF then ON to make the setting effective. See p. 15-7 for details.

■ CF card/USB-Memory set menu

◇ CF/USB-Memory set screen arrangement

• CF/USB-Memory set menu

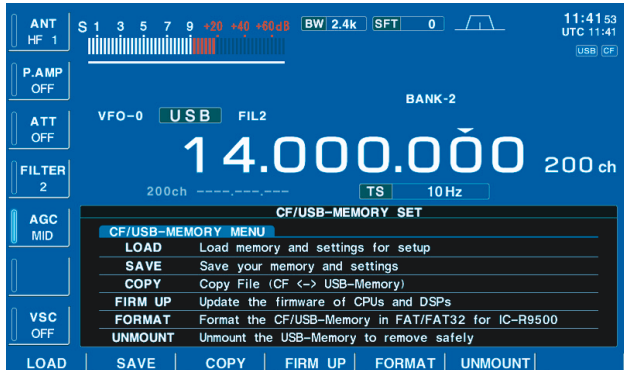

• Setting load screen (p. 11-19)

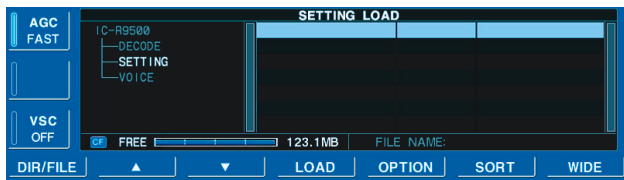

• Load option set mode (p. 11-17)

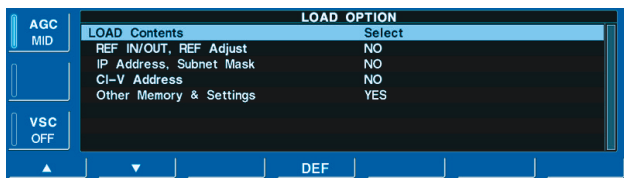

• Setting save screen (p. 11-18)

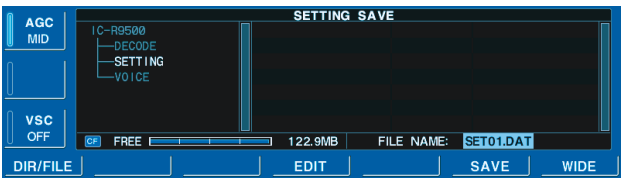

• Copy files (p. 11-21)

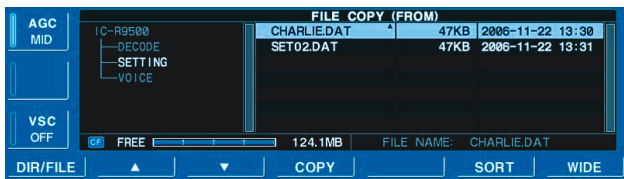

• Firmware update (p. 15-4)

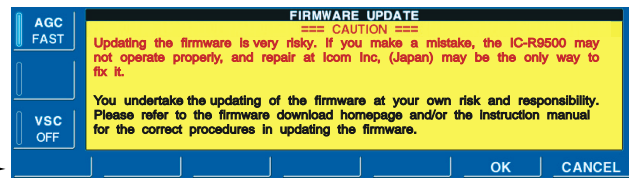

• Format menu (p. 11-23)

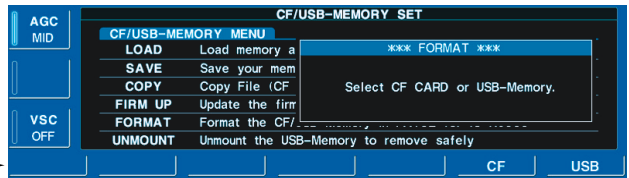

• Unmount USB-Memory (p. 11-22)

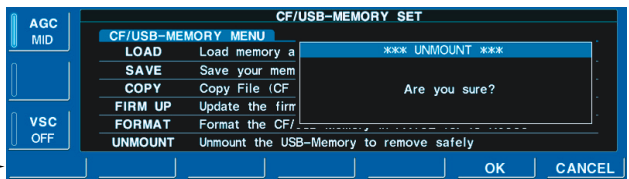

◇ Load option set mode

LOAD Contents	Select
Selects file loading condition from All and Select. (default: Select)	<ul style="list-style-type: none"> • All : Loads and sets the all following contents. • Select : Loads and sets the selected contents only.
REF IN/OUT, REF Adjust	NO
Selects the reference signal setting loading condition YES and NO. (default: NO).	<ul style="list-style-type: none"> • YES : Loads and sets the reference signal setting. • NO : Use the original reference signal setting.
IP Address, Subnet Mask	NO
Selects the IP address and subnet mask setting load- ing condition YES and NO. (default: NO).	<ul style="list-style-type: none"> • YES : Loads and sets the IP address and subnet mask setting. • NO : Use the original IP address and subnet mask setting.
CI-V Address	NO
Selects the CI-V address setting loading condition YES and NO. (default: NO).	<ul style="list-style-type: none"> • YES : Loads and sets the CI-V address setting. • NO : Use the original CI-V address setting.
Other Memory & Settings	YES
Selects memory channel contents and other settings loading condition YES and NO. (default: YES).	<ul style="list-style-type: none"> • YES : Loads and sets memory channel contents and other settings. • NO : Use the original memory channel contents and other settings.

File saving

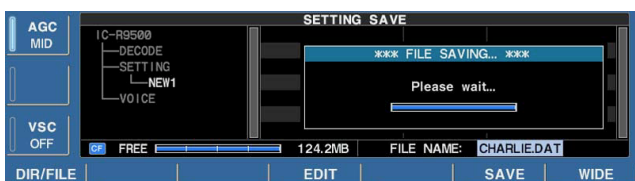
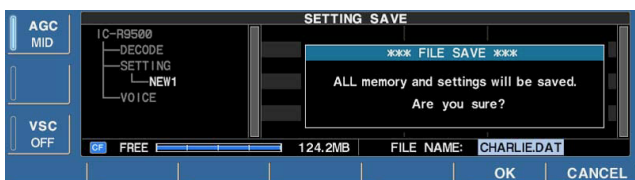
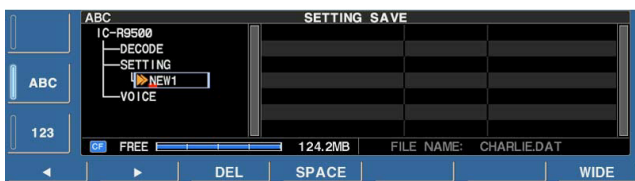
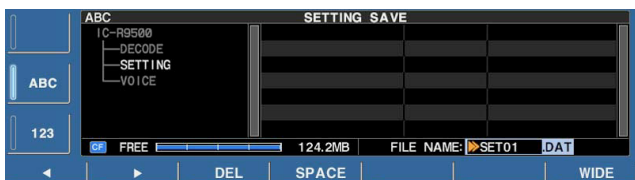
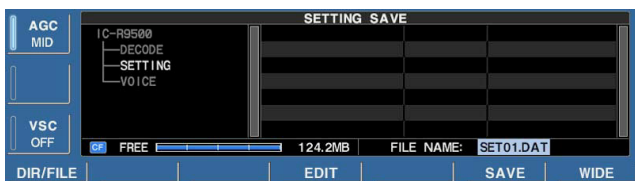
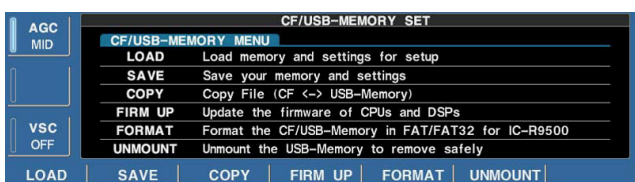
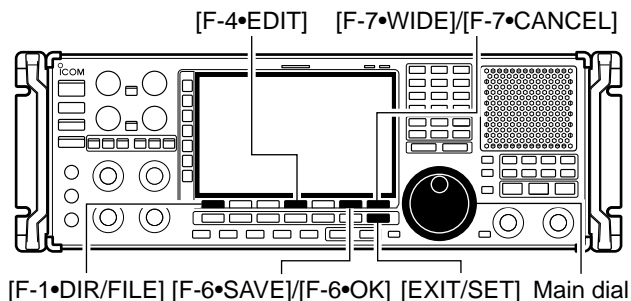

Memory channel contents, set mode settings, etc. can be saved into the CF (Compact Flash) memory card or USB-memory for backup.

- ① During set mode menu screen indication, push [F-7•CF/USB] to select CF/USB-Memory set menu screen.
- ② Push [F-2•SAVE] to select setting save screen.
- ③ Change the following conditions if desired.

• **File name:**

- ① Push [F-4•EDIT] to select file name edit condition.
 - Push [F-1• DIR/FILE] several times to select the file name, if necessary.
- ② Push [ABC], [123] or [Symbol] to select the character group, then rotate the main dial to select the character.
 - Push [123] or [Symbol] to toggle numerals and symbols.
 - [ABC] : A to Z (capital letters); [123]: 0 to 9 (numerals); [Symbol]: ! # \$ % & ' ` ^ + - = () [] { } _ ~ @ can be selected.
 - Push [F-1•◀] to move the cursor left, push [F-2•▶] to move the cursor right, push [F-3•DEL] to delete a character and push [F-4•SPACE] to insert a space.
- ③ Push [EXIT/SET] to set the file name.

• **Saving location**

- ① Push [F-1•DIR/FILE] to select tree view screen.
 - Push and hold [F-1•DIR/FILE] for 1 sec. once or twice to select the CF card or USB-Memory, when USB memory is Inserted.
- ② Select the desired directory or folder in the CF memory card.
 - Push [F-4•◀▶] to select the upper directory.
 - Push [F-2•▲] or [F-3•▼] to select folder in the same directory.
 - Push and hold [F-4•◀▶] for 1 sec. to select a folder in the directory.
 - Push [F-5•REN/DEL] to rename the folder.
 - Push and hold [F-5•REN/DEL] for 1 sec. to delete the folder.
 - Push and hold [F-6•MAKE] for 1 sec. to making a new folder. (Edit the name with the same manner as the “• File name” above.)
- ③ Push [F-1•DIR/FILE] twice to select the file name.
- ④ Push [F-6•SAVE].
 - Confirmation screen appears.
- ⑤ Push [F-6•OK] to save.
 - After saving is completed, return to CF/USB-Memory set menu automatically.

■ File loading

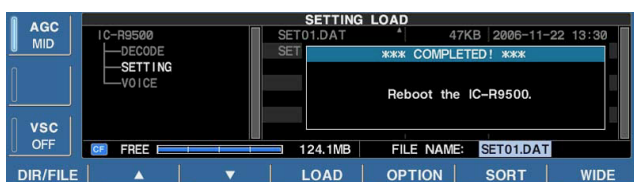
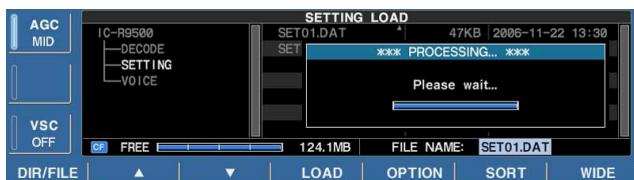
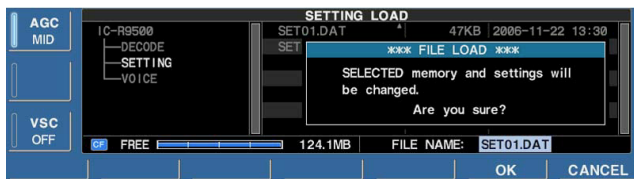
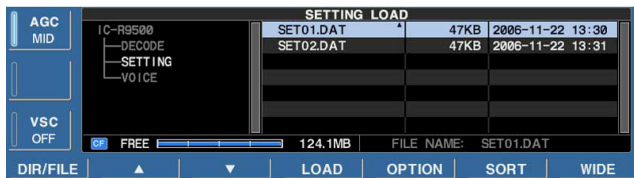
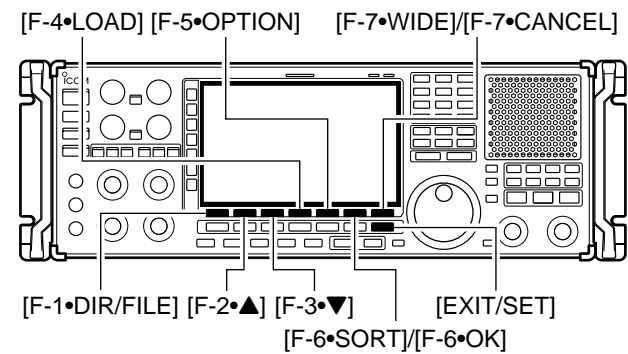

By loading the saved setting file from the CF memory card or USB-Memory, you can easily set up another IC-R9500—several operators settings can easily be applied to one IC-R9500.

- ① During set mode menu screen indication, push [F-7•CF/USB] to select CF/USB-Memory set menu screen.
- ② Push [F-1•LOAD] to select setting load screen.
- ③ Push [F-5•OPTION] to select load option set mode, then set the desired loading conditions, if desired.
 - See page 11-17 for details.
- ④ Push and hold [F-1•DIR/FILE] for 1 sec. once or twice to select the CF card or USB-Memory, when USB memory is Inserted.
- ⑤ Push [F-2•▲] or [F-3•▼] to select the desired setting file.
- ⑥ Push [F-4•LOAD].
 - Confirmation screen appears.
- ⑦ Push [F-6•OK] to starts loading.
 - After the loading is completed, the message dialog, “Reboot the IC-R9500,” appears.
- ⑧ Turn the receiver power OFF then ON to make the setting effective.

■ Changing the file name

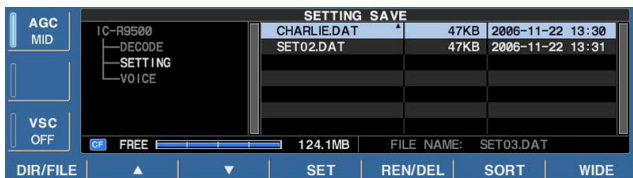
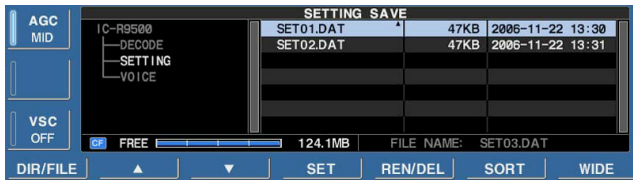
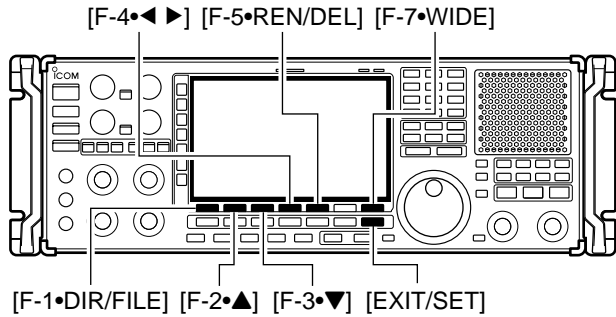

The file name, saved in the CF memory card or USB-memory, can be re-named from the receiver as desired.

- ① During setting save screen display, push [F-1•DIR/FILE] to select tree view screen.
 - Push and hold [F-1•DIR/FILE] for 1 sec. once or twice to select the CF card or USB-Memory, when USB memory is Inserted.
 - Push [F-2•▲] or [F-3•▼] to select the desired folder.
 - “DECODE,” “SETTING” and “VOICE” folders are available as the default.
 - After the folder is selected, push and hold [F-4•◀▶] for 1 sec. to display content folder(s), if available.
- ② Push [F-1•DIR/FILE] to select file list screen.
- ③ Push [F-2•▲] or [F-3•▼] to select the desired file.
- ④ Push [F-5•REN/DEL] momentarily to select the file name edit condition.
- ⑤ Push [ABC], [123] or [Symbol] to select the character group, then rotate the main dial to select the character.
 - Push [123] or [Symbol] to toggle numerals and symbols.
 - [ABC] : A to Z (capital letters); [123]: 0 to 9 (numerals); [Symbol]: ! # \$ % & ' ` ^ + - = () [] { } _ ~ @ can be selected.
 - Push [F-1•◀] to move the cursor left, push [F-2•▶] to move the cursor right, push [F-3•DEL] to delete a character and push [F-4•SPACE] to insert a space.
 - Using the receiver’s keypad, [0]–[9], can also enter numerals.
- ⑥ Push [EXIT/SET] to set the file name.

File copying

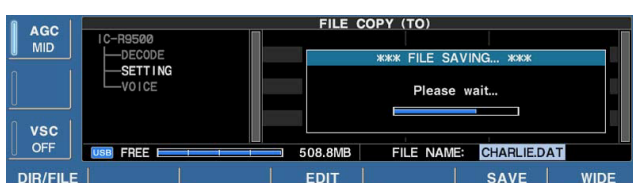
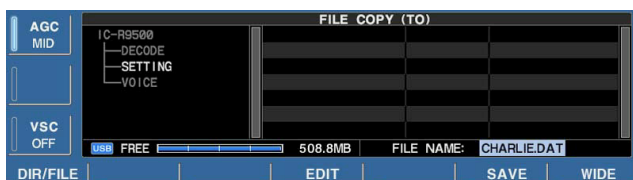
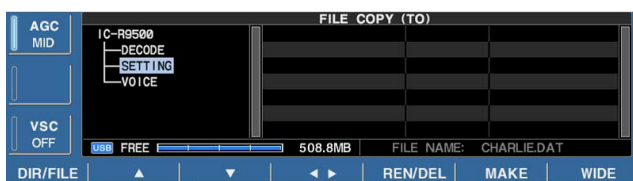
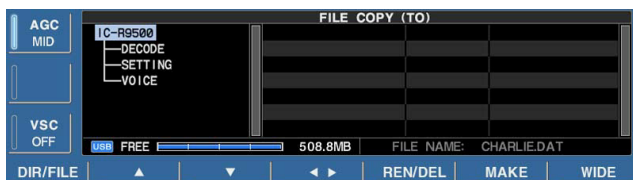
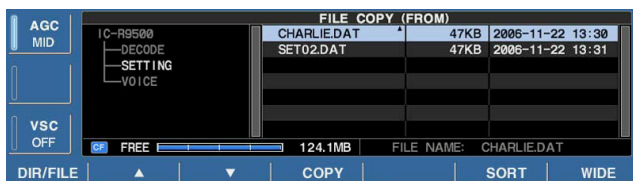
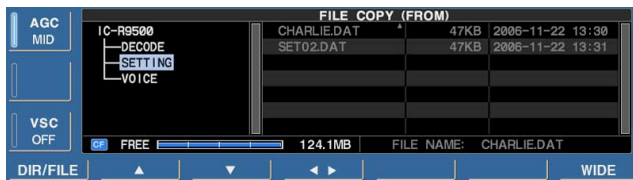
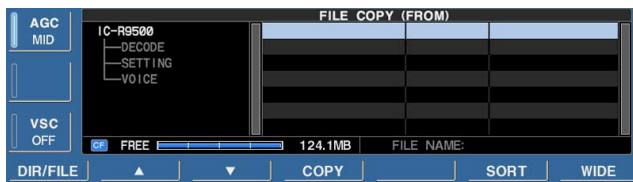
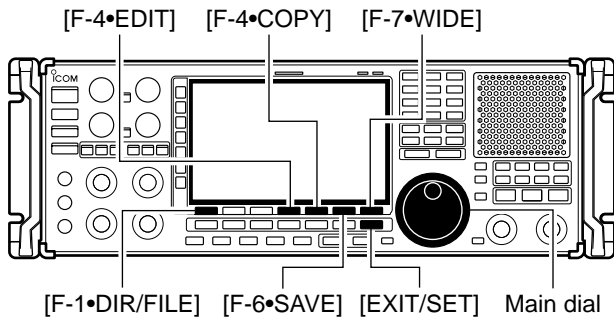

Memory channel contents, set mode settings, etc. in CF card or USB-Memory can be copied between memory devices for backup.

- ① During set mode menu screen indication, push [F-7•CF/USB] to select CF/USB-Memory set menu screen.
- ② Push [F-3•COPY] to select file copy screen.

• Select the original file

(Example Copying CF card to USB-Memory)

- ① Push [F-1•DIR/FILE] to select tree view screen.
 - Push and hold [F-1•DIR/FILE] for 1 sec. to select the CF card, if USB-Memory is selected.
 - Push [F-2•▲] or [F-3•▼] to select the desired folder.
 - After the folder is selected, push and hold [F-4•◀▶] for 1 sec. to display content folder(s), if available.
- ② Push [F-1•DIR/FILE] to select file list screen.
- ③ Push [F-2•▲] or [F-3•▼] to select the desired file.
- ④ Push [F-4•COPY] to select the file.

• Saving location

- ① Push and hold [F-1•DIR/FILE] for 1 sec. to select the USB-Memory.
- ② Select the desired directory or folder in the USB-Memory.
 - Push [F-4•◀▶] to select the upper directory.
 - Push [F-2•▲] or [F-3•▼] to select folder in the same directory.
 - Push and hold [F-4•◀▶] for 1 sec. to select a folder in the directory.
 - Push [F-5•REN/DEL] to rename the folder.
 - Push and hold [F-5•REN/DEL] for 1 sec. to delete the folder.
 - Push [F-6•MAKE] for 1 sec. to making a new folder
- ③ Push [F-1•DIR/FILE] twice to select the file name.
 - ③ Push [F-6•SAVE].
 - After saving is completed, return to CF/USB-Memory set menu automatically.

■ Deleting a file

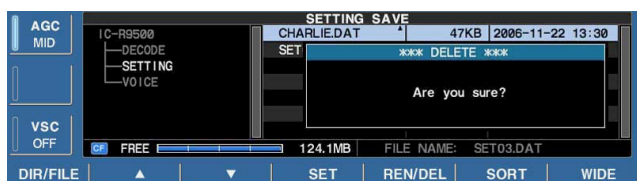
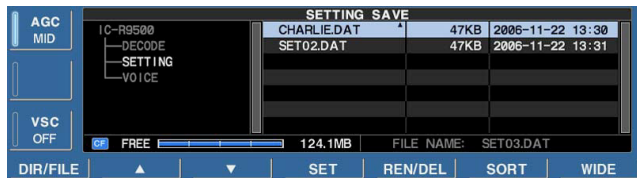

RECOMMENDATION! Deleting the setting file is irreversible. Confirm the contents before deleting a setting file!

- ① During setting save screen display, push [F-1•DIR/FILE] to select tree view screen.
 - Push [F-2•▲] or [F-3•▼] to select the desired folder.
 - “DECODE,” “SETTING” and “VOICE” folders are available as the default.
 - After the folder is selected, push and hold [F-2•◀▶] for 1 sec. to display content folder(s), if available.
- ② Push [F-1•DIR/FILE] to select file list screen.
- ③ Push [F-2•▲] or [F-3•▼] to select the desired file to be deleted.
- ④ Push and hold [F-5•REN/DEL] for 1 sec.
 - Confirmation screen appears.
- ⑤ Push [F-6•OK] to delete.
 - After the deleting, return to setting save screen automatically.

■ Unmount an USB-Memory

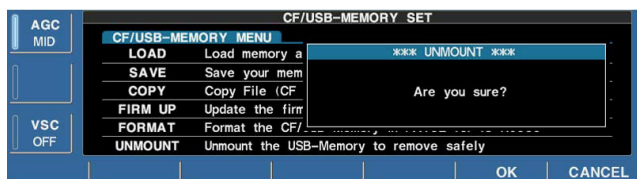

CAUTION! When removing the USB-Memory, unmount operation is necessary. Unless otherwise inside data of USB-Memory may be damaged.

- ① Push and hold [F-6•UNMOUNT] for 1 sec.
 - Confirmation screen appears.
- ② Push [F-6•OK] to unmount the USB-Memory.
- ③ After “**USB**” indication disappears, remove the USB-Memory.

■ Formatting the CF card or USB-Memory

Saved data in the CF card or USB-Memory can be erased.

/// **IMPORTANT!** Formatting erases all saved data in the CF card/USB-Memory. Backing up your memory device on your PC is recommended.

- ① During CF/USB-Memory set menu display, push and hold [F-4•FORMAT] for 1 sec.
 - Selection screen appears.
- ② Push [F-6•CF] or [F-7•USB] to select CF card or USB-Memory, respectively.
- ③ Push [F-6•FAT] or [F-7•FAT32] to select the format type, FAT or FAT32, respectively.
 - Confirmation screen appears.
- ④ Push [F-6•OK] to format.
 - Push [F-7•CANCEL] to cancel.
- ⑤ Returns to CF card set menu indication automatically.

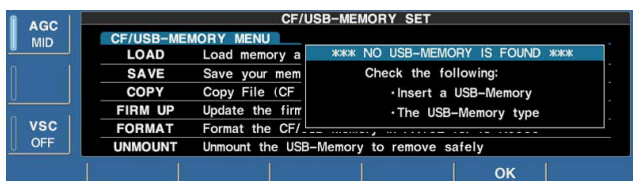
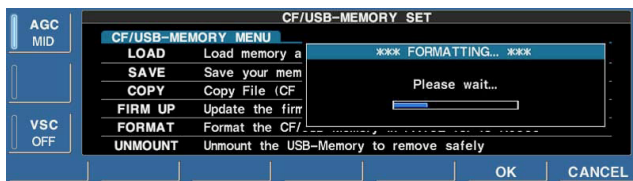
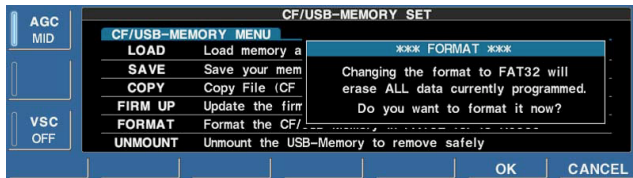
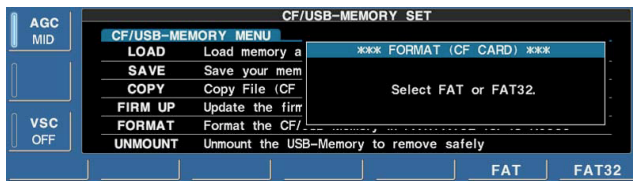
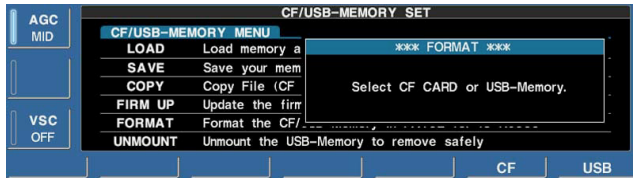

/// **NOTE:** If no USB-Memory is inserted and [F-7•USB] is selected as in step ②, an error message appears.

Display set (Video) mode

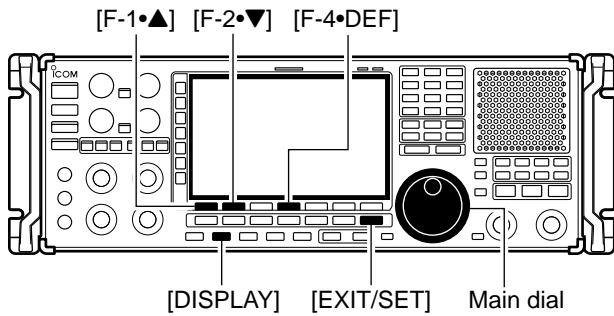

This set mode is used to set the HSB (Hue, Saturation, Brightness) color setting for video input or output, etc.

NOTE: “Display set mode” is described on page 11-8.

- ① Push [DISPLAY] momentarily to turn the mini video screen, if necessary.
- ② Push and hold [DISPLAY] for 1 sec. to select the display set (Video) mode.
- ③ Push [F-1•▲] or [F-2•▼] to select the desired set item.
- ④ Set the desired condition using the main dial.
 - Push and hold [F-4•DEF] for 1 sec. to select a default condition or value.
- ⑤ Push [EXIT/SET] to exit from set mode.

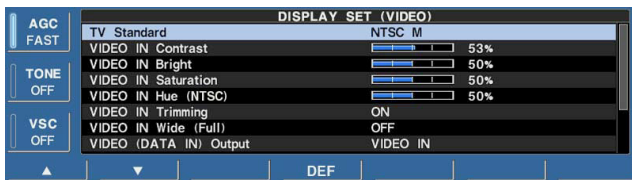

NOTE: Video output from [DATA IN] is available an NTSC system only.

TV Standard	NTSC M
Selects the TV system of your local area from “NTSC M,” “PAL B/G,” “PAL I,” “PAL D” and “SECAM K.”	NOTE: <ul style="list-style-type: none"> • This setting is not available for USA versions. • Default setting is different depending on versions.

VIDEO IN Contrast	53%
Adjusts the LCD contrast of the video signal from [VIDEO IN] jack. Adjustable range is 0 (low contrast) to 100% (high contrast) in 1% steps. (default: 50%)	

VIDEO IN Bright	50%
Adjusts the LCD brightness of the video signal from [VIDEO IN] jack. Adjustable range is 0 (dark) to 100% (bright) in 1% steps. (default: 50%)	

VIDEO IN Saturation	50%
Adjusts the saturation (vibrancy of the color) of the video signal from [VIDEO IN] jack. Adjustable range is 0 (shade of gray) to 100% (vivid color) in 1% steps. (default: 50%)	

VIDEO IN Hue (NTSC)	50%
Adjusts the hue (color type) of the video signal from [VIDEO IN] jack. Adjustable range is 0 (red) to 100 (green) in 1 steps. (default: 50)	NOTE: This setting is available when NTSC system signal is input from [VIDEO IN] connector.

■ Display set (Video) mode (continued)

VIDEO IN Trimming

ON

Trims the frame of the video signal from [VIDEO IN] jack. (default: ON)

OFF : Displays the entire area of video signal.
 ON : Cuts the frame area (each 4% width of upper, bottom, left and right areas) and expands the rest of area.

VIDEO IN Wide (Full)

ON

Selects the wide screen capability ON and OFF.

/// **NOTE:** This setting is effective for the full screen only.

VIDEO (DATA IN) Output

VIDEO IN

Selects the output video signal from pin 2 of [DATA IN] socket. (default: VIDEO IN)

VIDEO IN : Outputs a video signal that is the same as the input from [VIDEO IN] jack.
 LCD : Outputs a video signal that is the same as the LCD.

VIDEO Out Horizontal Size

1

Adjusts the horizontal width of the output video signal from pin 2 of [DATA IN] socket. Adjustable range is 1 (narrow) to 4 (wide) in 1 steps. (default: 1)

VIDEO Out Setup Level

7.5IRE

Selects the setup level of the output video signal from pin 2 [DATA IN] socket. Selectable items are 0IRE (JPN NTSC) or 7.5IRE (USA NTSC).

/// **NOTE:** Default setting is different depending on versions.

VIDEO Out Saturation



80%

Adjusts the saturation (vibrancy of the color) of the output video signal from pin 2 of [DATA IN] jack. Adjustable range is 0 (shade of gray) to 100% (vivid color) in 1% steps. (default: 80%)

VIDEO Out Hue



50%

Adjusts the hue (color type) of the output video signal from pin 2 of [DATA IN] jack. Adjustable range is 0 (red) to 100 (green) in 1 steps. (default: 50)

■ LCD set mode

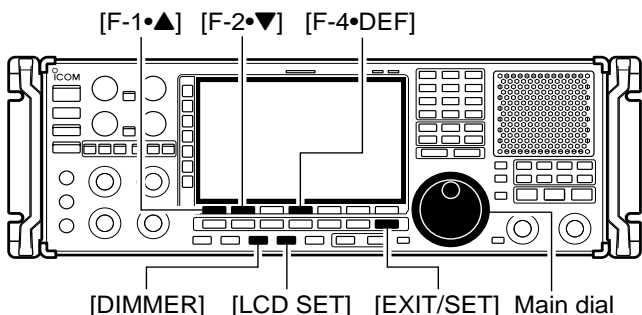

This set mode is used to set the LCD contrast, brightness and other settings for 2 condition of the dimmer function ON and OFF.

- ① Push [LCD SET] to select LCD set mode.
- ② Push [DIMMER] once or twice to select the dimmer function ON or OFF.
- ③ Push [F-1•▲] or [F-2•▼] to select the desired set item.
- ④ Set the desired condition using the main dial.
 - Push and hold [F-4•DEF] for 1 sec. to select a default condition or value.
 - Push and hold [DIMMER] for 3 sec. to reset to a default condition or value for all items at the same time.
- ⑤ Push [DIMMER] once to select the other dimmer setting, and repeat steps ③ and ④.
- ⑥ Push [EXIT/SET] to exit from set mode.

• Dimmer function OFF

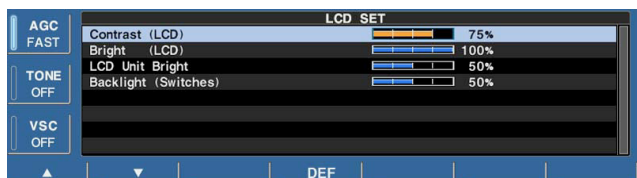

• Dimmer function ON

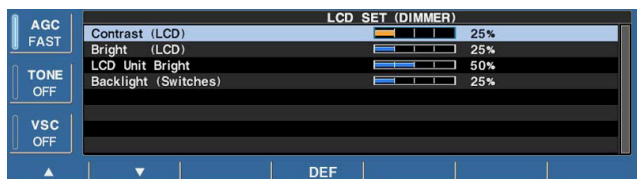

Contrast (LCD)



Adjusts the contrast of the LCD from 0 (low contrast) to 100% (high contrast) range in 1% steps.

Default setting:
Dimmer function OFF : 75%
Dimmer function ON : 25%

Bright (LCD)



Adjusts the brightness of the LCD from 0 (dark) to 100% (bright) range in 1% steps.

Default setting:
Dimmer function OFF : 100%
Dimmer function ON : 25%

LCD Unit Bright



Adjusts the brightness of LCD unit from 0 (dark) to 100% (bright) range in 1% steps.

Default setting:
Dimmer function OFF : 50%
Dimmer function ON : 50%

Backlight (Switches)



Adjusts the brightness of switch indicators from 1 (dark) to 100 (bright) range in 1 steps.

Default setting:
Dimmer function OFF : 50%
Dimmer function ON : 25%

■ Troubleshooting	12-2
◇ Receiver power	12-2
◇ Receiving	12-2
◇ Scanning	12-3
◇ Display	12-3
◇ Voice recorder	12-3
◇ Format memory media	12-3
■ Screen type selection	12-4
■ Main dial brake adjustment	12-4
■ Frequency calibration (approximate)	12-5
■ Opening the receiver's case	12-6
■ Opening the shield case	12-6
■ UT-122 installation	12-7
■ Clock backup battery replacement	12-7
■ Fuse replacement	12-8
◇ AC power input fuse	12-8
◇ DC output fuse	12-8
■ Resetting the CPU	12-9
■ Screen Saver Function	12-9

■ Troubleshooting

The following chart is designed to help you correct problems which are not equipment malfunctions. If you are unable to locate the cause of a problem or solve it through the use of this chart, contact you nearest Icom Dealer or Service Center.

◇ Receiver power

PROBLEM	POSSIBLE CAUSE	SOLUTION	REF.
Power does not come on when the [POWER] switch is pushed.	<ul style="list-style-type: none"> Power cable is improperly connected. DC-DC power plug is improperly connected. The internal power supply is turned OFF. The fuse is blown. 	<ul style="list-style-type: none"> Re-connect the AC power cable correctly. Re-connect the DC-DC power plug correctly. Turn the internal power supply ON. Check for the cause, then replace the fuse. 	— — p. 3-2 p.12-8

◇ Receiving

PROBLEM	POSSIBLE CAUSE	SOLUTION	REF.
No sounds come out from the speaker.	<ul style="list-style-type: none"> Volume level is too low. The squelch is closed. The RF gain is too decreases sensitivity. 	<ul style="list-style-type: none"> Rotate [AF] clockwise to obtain a suitable listening level. Turn [SQL] to 10 o'clock position to open the squelch. Rotate [RF GAIN] clockwise to obtain an enough sensitivity. 	p. 3-8 p. 3-8 p. 3-8
Sensitivity is too low, and only strong signals are audible.	<ul style="list-style-type: none"> The antenna is not connected properly. The attenuator is activated. A different antenna for HF band is selected. 	<ul style="list-style-type: none"> Re-connect the antenna. Push [ATT] several times to select "ATT OFF." Push [ANT] several times to select the correct antenna for the HF band. 	— p. 5-9 p. 9-3
Received audio is unclear or distorted.	<ul style="list-style-type: none"> Wrong operating mode is selected. PBT function is activated. Noise blanker is turned ON when receiving a strong signal. Preamp is activated. The noise reduction is activated and the [NR] control is too far clockwise. 	<ul style="list-style-type: none"> Select a suitable operating mode. Push [PBT CLR] for 1 sec. to reset the function. Push [NB] to turn the noise blanker OFF. Push [P.AMP] once or twice to turn the function OFF. Set the [NR] control for maximum readability. 	p. 3-7 p. 5-11 p. 5-15 p. 5-9 p. 5-16
The [ANT] switch does not function	<ul style="list-style-type: none"> The selected frequency is above 30 MHz. 	<ul style="list-style-type: none"> Select a frequency below 30 MHz. 	pgs. 3-4, 9-3
[AFC] cannot be turned ON.	<ul style="list-style-type: none"> The operating mode is not set in FM or WFM mode. 	<ul style="list-style-type: none"> Select FM or WFM mode to activate AFC. 	pgs. 3-7, 5-17
[AUTOTUNE](AFC) cannot be turned ON.	<ul style="list-style-type: none"> The operating mode is set in FM, WFM, FSK or P25 mode. 	<ul style="list-style-type: none"> Select AM, SSB or CW mode to activate AUTOTUNE. 	pgs. 3-7, 5-17
[VSC] cannot be turned ON.	<ul style="list-style-type: none"> The operating mode is set in CW, FSK or P25 mode. 	<ul style="list-style-type: none"> Select FM, WFM, AM or SSB mode to activate VSC. 	pgs. 3-7, 8-3
[ANF] cannot be turned ON.	<ul style="list-style-type: none"> The operating mode is set in CW, FSK or P25 mode. 	<ul style="list-style-type: none"> Select FM, WFM, AM or SSB mode to activate ANF. 	pgs. 3-7, 5-16
[NOTCH1]/[NOTCH2] cannot be turned ON.	<ul style="list-style-type: none"> The operating mode is set in FM, WFM or P25 mode. 	<ul style="list-style-type: none"> Select AM, SSB, CW and FSK mode to activate MN1/MN2. 	pgs. 3-7, 5-16
The filter width cannot be changed.	<ul style="list-style-type: none"> The operating mode is set in WFM or P25 mode. 	<ul style="list-style-type: none"> Select FM, AM, SSB, CW and FSK mode. 	pgs. 3-7, 5-12
A synthesized voice is not emitted when pushing [SPCH].	<ul style="list-style-type: none"> "Speech Level" in the level set mode is too low "SPEECH Mix" in the others set mode is OFF. 	<ul style="list-style-type: none"> Set "Speech Level" to enough level in the set mode. Set "SPEECH Mix" to All or Operation in the set mode. 	p. 11-6 p. 11-11
No sounds come out or output level is too low from [S/P DIF OUT], [ACC], [LINE OUT], [REC OUT].	<ul style="list-style-type: none"> Either the audio tone controls is too decreases position 	<ul style="list-style-type: none"> Rotate [BASS] or [TREBLE] clockwise to obtain an enough audio output. 	p. 3-9

◇ Scanning

PROBLEM	POSSIBLE CAUSE	SOLUTION	REF.
Programmed scan does not stop.	<ul style="list-style-type: none"> Squelch is open. 	<ul style="list-style-type: none"> Readjust the [SQL] threshold. 	pgs. 3-8, 8-3
Scan does not start. (Programmed scan)	<ul style="list-style-type: none"> The same frequencies have been programmed in scan edge memory channels PxA and PxB. 	<ul style="list-style-type: none"> Program different frequencies in scan edge memory channel PxA and PxB. 	p. 8-6
(Memory scan)	<ul style="list-style-type: none"> 2 or more memory channels have not been programmed. 	<ul style="list-style-type: none"> Program more than 2 memory channels. 	pgs. 7-4, 8-11
(Select memory scan)	<ul style="list-style-type: none"> 2 or more memory channels have not been designated as select channels. 	<ul style="list-style-type: none"> Designate more than 2 memory channels as select channels for the scan. 	p. 8-12
(Mode select memory scan)	<ul style="list-style-type: none"> 2 or more memory channels with desired mode have not been programmed. 	<ul style="list-style-type: none"> Program more than 2 memory channels with desired operating mode. 	pgs. 7-4, 8-14
(ΔF scan)	<ul style="list-style-type: none"> The center frequency for ΔF scan does not programmed. 	<ul style="list-style-type: none"> Program the center frequency for ΔF scan. 	p. 8-8
(Auto memory write scan)	<ul style="list-style-type: none"> Auto write bank is full. 	<ul style="list-style-type: none"> Clear the memory channels of auto write bank. 	pgs. 7-7, 8-4

◇ Display

PROBLEM	POSSIBLE CAUSE	SOLUTION	REF.
No indication appears on the display.	<ul style="list-style-type: none"> The LCD settings are wrong in the LCD set mode. The panel lock with display sleep function is activated. 	<ul style="list-style-type: none"> Set LCD settings properly in the set mode. Push [PANEL LOCK] to turn the function OFF. 	p. 11-26 p. 9-2
The displayed frequency does not change properly.	<ul style="list-style-type: none"> The dial lock function is activated. The remote control operation is active. 	<ul style="list-style-type: none"> Push [LOCK] to turn the function OFF. Push [LOCAL] to cancel the remote control operation. 	p. 9-2 p. 1-2
The key operation on the front panel does not function.	<ul style="list-style-type: none"> The panel lock function is activated. The remote control operation is active. 	<ul style="list-style-type: none"> Push [PANEL LOCK] to turn the function OFF. Push [LOCAL] to cancel the remote control operation. 	p. 9-2 p. 1-2

◇ Voice recorder

PROBLEM	POSSIBLE CAUSE	SOLUTION	REF.
The voice recorder cannot record.	<ul style="list-style-type: none"> The selected memory media is full. 512 files already exist in folder. The maximum file name (V****999.wav) exists in folder. (Example: V0424999.wav, V1116999.wav) 	<ul style="list-style-type: none"> Select a different memory media or clear the unnecessary files. Clear the unnecessary files. Delete the file (V****999.wav), or change the file name. 	pgs. 6-4, 11-22 p. 11-22 pgs. 6-4, 11-20, 11-22
The voice recorder stops recording.	<ul style="list-style-type: none"> The recording memory media is full. The recording file size is at maximum (2 GB). 	<ul style="list-style-type: none"> Select a different memory media or clear the unnecessary files. Select a lower sound quality for long duration recording. 	p. 6-4 p. 6-6

◇ Format memory media

PROBLEM	POSSIBLE CAUSE	SOLUTION	REF.
Format error appears when formatting in FAT32	<ul style="list-style-type: none"> The inserted memory media capacity is smaller than 64 MB. 	<ul style="list-style-type: none"> Insert a memory media larger than 64 MB or select the FAT format. 	p. 11-23
Format error appears when formatting in FAT	<ul style="list-style-type: none"> The inserted memory media capacity is larger than 2 GB. 	<ul style="list-style-type: none"> Insert a memory media smaller than 2 GB or select the FAT32 format. 	p. 11-23

■ Screen type selection

• Screen image example— type A (default)



(Blue display)

• Screen image example— type B



(Black display)

2 types of screen images are available in the IC-R9500.

- ① Push [EXIT/SET] several times to close multifunction screen, if necessary.
- ② Push [F-7•SET] to select set mode menu screen.
- ③ Push [F-3•DISP] to enter the display set mode.
- ④ Push [F-1•▲] or [F-2•▼] to select “Display Type” item.
- ⑤ Rotate the main dial to select the desired screen image.
 - Screen image is selectable from A and B.
- ⑥ Push [EXIT/SET] twice to exit from the display set mode.

■ Main dial brake adjustment

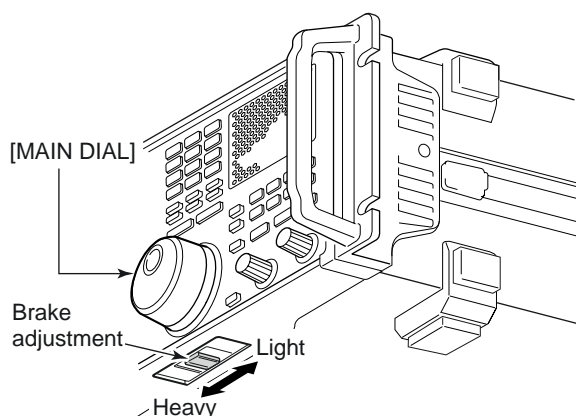

The tension of the main dial may be adjusted to suit your preference.

The brake adjustment is located on the bottom side of the front panel. See the figure at left.

Slide the brake adjustment to a comfortable tension level while turning the dial continuously and evenly in one direction.

■ Frequency calibration (approximate)

A very accurate frequency counter is required to calibrate the frequency of the receiver. However, a rough check may be performed by receiving radio station WWV, WWVH, or other standard frequency signals.

CAUTION: The IC-R9500 has been thoroughly adjusted and tested at the factory before being shipped. You should not have to re-calibrate it.

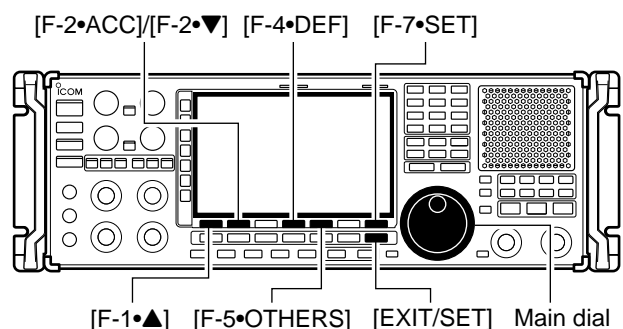

• REF Adjust item

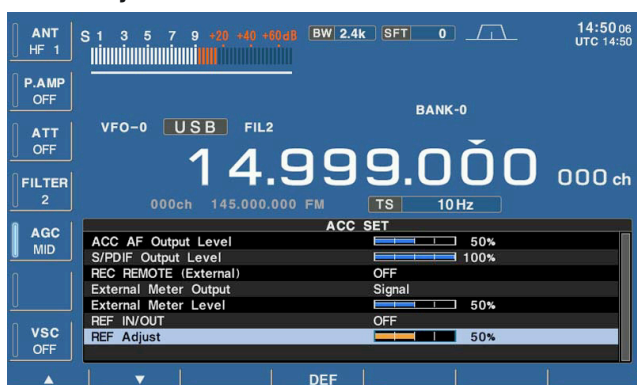

- ① Push [SSB] to select USB mode.
- ② Push and hold [PBT CLEAR] for 1 sec. to clear the PBT setting.
- ③ Set the frequency to the standard frequency station minus 1 kHz.
 - When receiving WWV or WWVH (at 15.00000 MHz) as a standard frequency, set the operating frequency for 14.99900 MHz.
 - Other standard frequencies can be used.
- ④ Push [EXIT/SET] several times to close a multi-function screen, if necessary.
- ⑤ Push [F-7•SET] to select set mode menu screen.
- ⑥ Push [F-5•OTHERS] to enter the others set mode.
- ⑦ Push [F-1•▲] several times to select the “Calibration Marker” item.
- ⑧ Rotate the main dial clockwise to turn the calibration marker ON.
- ⑨ Push [EXIT/SET] once to return to set mode menu screen.
- ⑩ Push [F-2•ACC] to enter accessory set mode.
- ⑪ Push [F-2•▼] several times to select the “REF Adjust” item.
- ⑫ Rotate the main dial to adjust for a zero beat with the received standard signal as shown at left.
 - Zero beat means that two signals are exactly the same frequency, resulting in a single tone being emitted.
- ⑬ Turn the calibration marker OFF in the others set mode.
- ⑭ Push [EXIT/SET] twice to exit set mode.

■ Opening the receiver's case

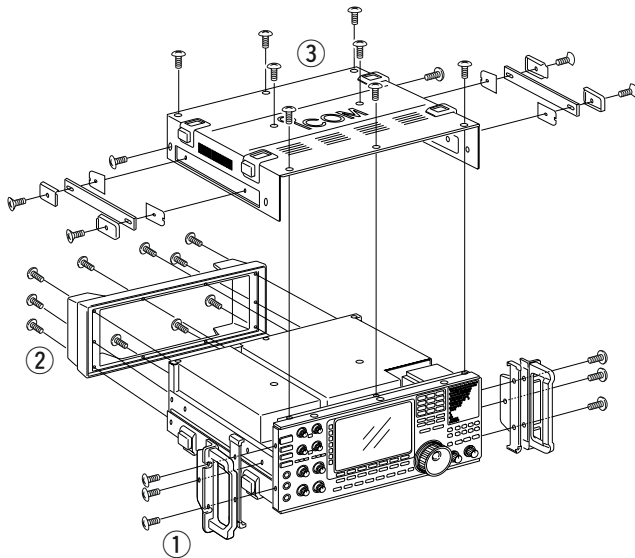

Follow the case opening procedures shown here when you want to install the optional unit UT-122, or replace the clock battery or internal fuse.

CAUTION!: DISCONNECT the AC power cable from the receiver before performing any work on the receiver. Otherwise, there is danger of electric shock and/or equipment damage.

CAUTION!: The receiver weighs approx. 20 kg (44 lb). Always have two people available to lift or turn over the receiver.

- ① Remove the 6 screws from the rack mounting handles. And remove the rack mounting handles and side plates.
- ② Remove the 10 screws from the rear of the receiver and remove the rear cover.
- ③ Remove the 8 screws from the top of the receiver and the 6 screws from the sides, then lift up the top cover.

CAUTION: NEVER HOLD THE MAIN DIAL OR ANY OTHER KNOBS when lifting the receiver. This may damage the receiver.

■ Opening the shield case

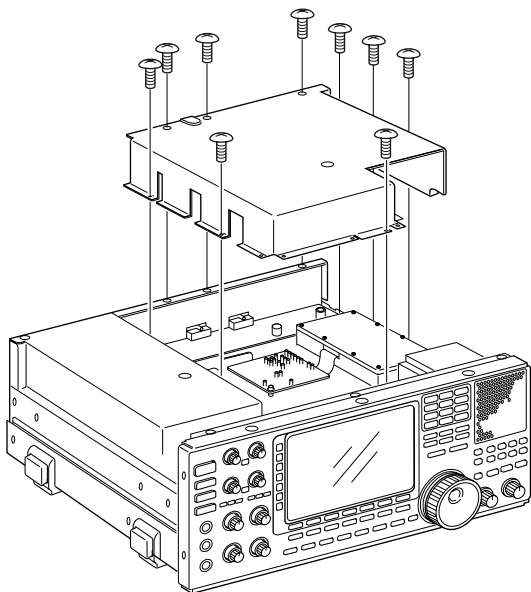

Follow the case opening procedures shown here when you want to replace the internal fuse or optional UT-122 installation.

- ① Remove the 9 screws from the shield cover of the receiver's top side.
- ② Lift up the shield cover.

■ UT-122 installation

The optional UT-122 DIGITAL UNIT provides P25 (digital) mode operation.

WARNING: DISCONNECT the AC power cable from the AC outlet before removing the receiver's cover.

- ① Remove the top cover and inside cover as shown at left page.
- ② Connect the UT-122 as shown left.
 - Remove the protective paper from the UT-122 in advance.
- ③ Return the inside cover and top cover and screws to the original position.

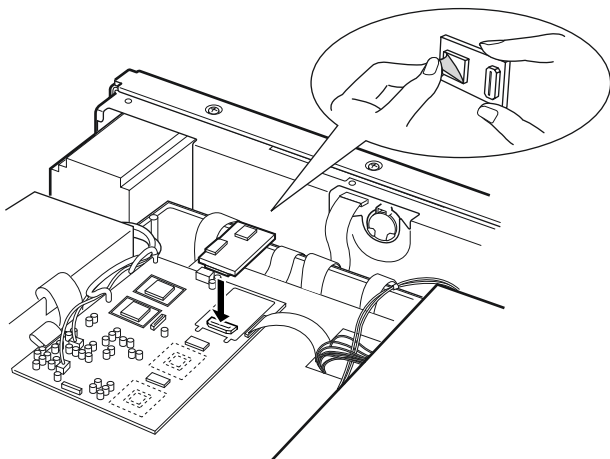

■ Clock backup battery replacement

The IC-R9500 has a lithium backup battery (CR2032) inside for clock and timer functions. The usual life of the backup battery is approximately 2 years.

When the backup battery is drained, the receiver receives normally but cannot retain the current time.

WARNING: DISCONNECT the AC power cable from the AC outlet before removing the receiver's cover.

- ① Remove the top cover as shown at left page.
- ② Replace the clock backup battery, located on the front panel as illustrated at left.
 - Make sure the battery polarity is correct.
- ③ Return the top cover to the original position.
- ④ Set the date and time in time set mode. (p. 10-2)

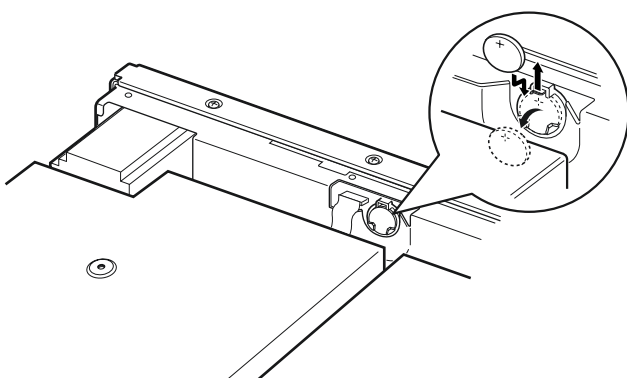

■ Fuse replacement

IC-R9500 has two fuses for receiver protection.
AC power input : 4 A (for 100/120 V AC versions)
2 A (for 230/240 V AC versions)

DC output jack : 1 A

If the fuse blows or the receiver stops functioning, find the sources of the problem, if possible, and replace the damaged fuse with a new fuse of the same rating.

WARNING: DISCONNECT the AC power cable from the AC outlet before removing the receiver's cover. This can prevent shock to the user or damage to the receiver.

◇ AC power input fuse

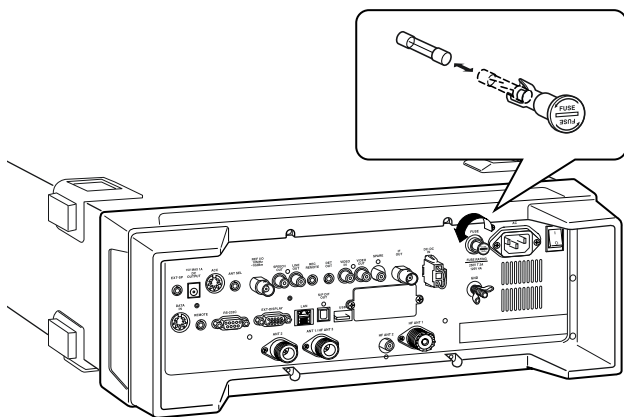

The AC power input fuse is held in the [FUSE] holder.

- ① Unscrew the [FUSE] holder using a standard screw driver.
- ② Replace the open fuse with a new, properly rated one as shown at left.

◇ DC output fuse

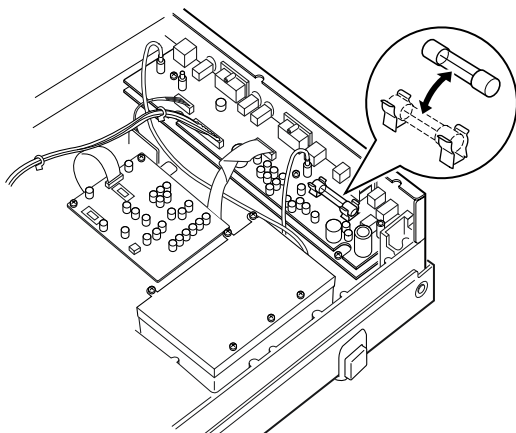

When no external DC output is available from [EXT DC] and ACC connector, the internal fuse may be open. Replace the fuse in this case.

- ① Remove the top cover and shield case as shown at page 12-6.
- ② Replace the open fuse with a new, properly rated one (FGB 1 A) as shown at left.
- ③ Replace the shield case and top cover.

■ Resetting the CPU

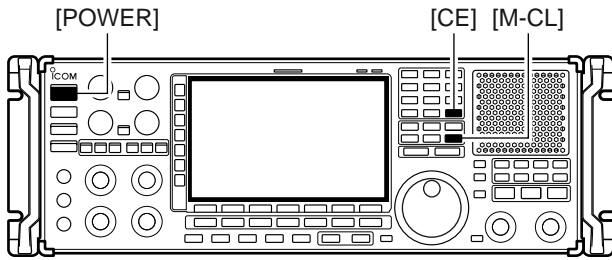

- ① Turn the main power switch on the rear panel ON.
 - Make sure the receiver power is still OFF.
- ② While pushing and holding [CE] and [M-CL], push [POWER] to turn power ON.
 - The internal CPU is reset.
 - The CPU start-up takes approx. 5 sec.
 - The receiver displays its initial VFO frequencies when resetting is complete.
- ③ Correct the set mode settings after resetting, if desired.

/// **NOTE:** Resetting **CLEARs** all programmed contents in memory channels and returns programmed values in set mode to default values.

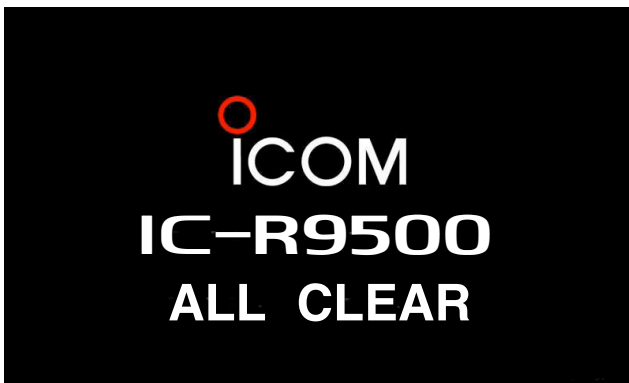

■ Screen saver function

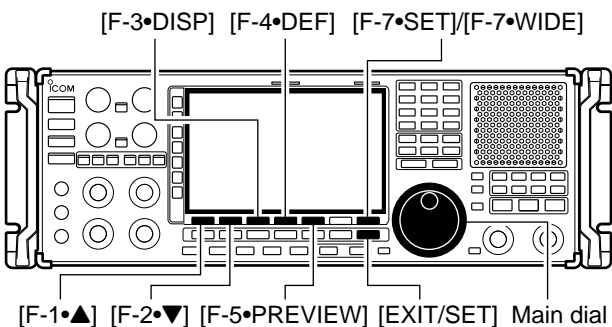

The IC-R9500 has a screen saver function to protect the LCD from the “burn-in” effect.

- ① Push [EXIT/SET] several times to close a multi-function screen, if necessary.
- ② Push [F-7•SET] to select set mode menu screen.
- ③ Push [F-3•DISP] to enter the display set mode.
- ④ Push [F-1•▲]/[F-2•▼] several times to select the “Screen Saver Function” item.
- ⑤ Rotate main dial to select the desired time period for the screen saver activation from 15, 30, 60 min. and OFF.
 - Deactivate the screen saver with “OFF” selection.
 - Push and hold [F-5•PREVIEW] to display the indication for your reference.
- ⑥ Push [EXIT/SET] twice to exit the set mode.

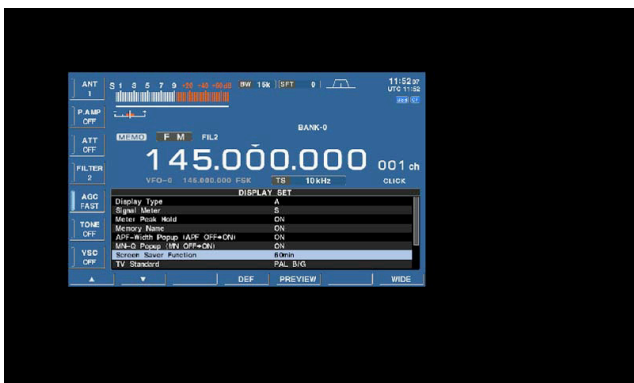

- Remote interface (CI-V) information 13-2
 - ◇ CI-V connection example 13-2
 - ◇ Data format 13-2
 - ◇ Command table 13-3
 - ◇ To send/read memory contents 13-10
 - ◇ Codes for memory name, bank name, opening message,
and clock 2 name contents 13-10
 - ◇ Offset frequency setting 13-10
 - ◇ Tone squelch frequency setting 13-10
 - ◇ DTCS squelch code setting 13-10
 - ◇ NAC squelch code setting 13-11
 - ◇ Selective squelch code settings 13-11
 - ◇ Color setting 13-11
 - ◇ Data mode with filter width setting 13-11

Remote interface (CI-V) information

CI-V connection example

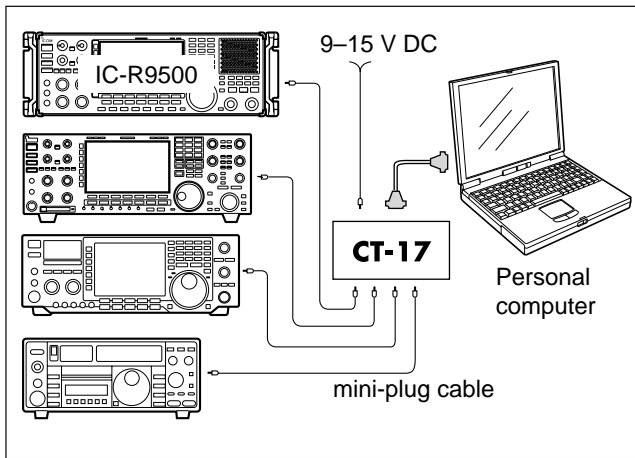

The receiver can be connected through an optional CT-17 CI-V LEVEL CONVERTER to a PC equipped with an RS-232C port. The Icom Communications Interface-V (CI-V) controls the receiver.

Up to 4 Icom CI-V transceivers or receivers can be connected to a PC equipped with an RS-232C port. See p. 11-14 for configuring the CI-V using set mode.

Data format

The CI-V system uses the following data formats. Data formats differ according to command numbers. A data area or sub command is added for some commands.

Controller to IC-R9500

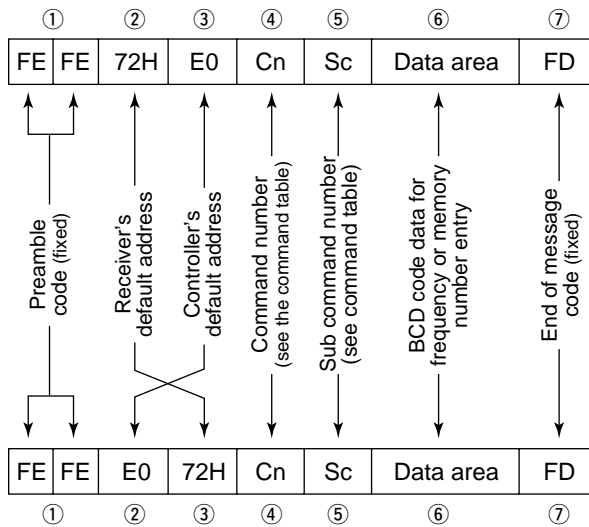

IC-R9500 to controller

OK message to controller

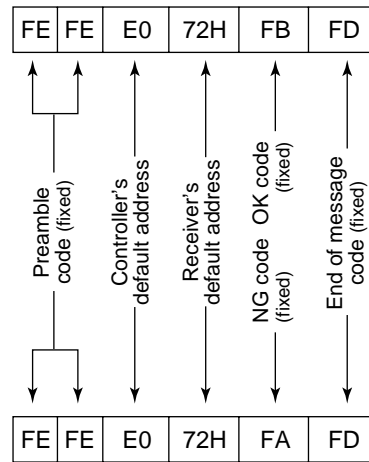

NG message to controller

◆ Command table

Command	Sub command	Description	Command	Sub command	Description	
00	—	Send frequency data	0E	D1	Set scan resume ON (Close Timer)	
01	Same as command 06	Send mode data		D3	Set scan resume ON (Close and Delay)	
02	—	Read upper/lower frequencies for selected band		10	Turn duplex OFF. (Simplex)	
03	—	Read operating frequency	11	Turn duplex ON. (DUP-)		
04	—	Read operating mode	12	Turn duplex ON. (DUP+)		
05	—	Set operating frequency	10	00	Select 1 Hz tuning step	
06	00	Select LSB		01	Select 10 Hz tuning step	
	01	Select USB		02	Select 100 Hz tuning step	
	02	Select AM		03	Select 1 kHz tuning step	
	03	Select CW		04	Select 2.5 kHz tuning step	
	04	Select FSK		05	Select 5 kHz tuning step	
	05	Select FM		06	Select 6.25 kHz tuning step	
	07	Select CW-R		07	Select 9 kHz tuning step	
	08	Select FSK-R		08	Select 10 kHz tuning step	
07	—	Select (Last selected) VFO mode		09	Select 12.5 kHz tuning step	
	08	—		Select memory mode	10	Select 20 kHz tuning step
				Select memory channel	11	Select 25 kHz tuning step
				*0–999, 1000–1099 (A00–A99), 1100–1199 (S00–S99), 1200–1219 (P0A–P9A)	12	Select 100 kHz tuning step
				Select memory bank	13	Select 1 MHz tuning step
		0–12*	*0–9, 10 (Bank-A), 11 (Bank-S), 12 (Bank-P)	14	Select Prog tuning step	
			—	Select/read attenuator (00=OFF; 06=6 dB; 10=10 dB; 12=12 dB; 18=18 dB; 20=20 dB; 24=24 dB; 30=30 dB)	11	—
			—	Select/read the antenna below 30 MHz. (00=HF ANT1, 01=HF ANT2, 02=HF ANT3)	12	00 01 02
—			Announce with voice synthesizer (00=all data; 01=frequency and S-meter level; 02=receive mode)	13	00 01 02	
09	—	Memory write	14	01 + Level data	[AF] level setting (0=max. CCW to 255=max. CW)	
0A	—	Memory to VFO		02 + Level data	[RF] level setting (0=max. CCW to 255=11 o'clock)	
0B	—	Memory clear		03 + Level data	[SQL] level setting (0=11 o'clock to 255=max. CW)	
0C	—	Read offset frequency (see p. 13-10 for details)		06 + Level data	[NR] level setting (0=min. to 255=max.)	
0D	—	Set offset frequency (see p. 13-10 for details)		07 + Level data	Left [TWIN PBT] setting or IF shift setting (0=max. CCW, 128=center, 255=max. CW)	
0E	00	Scan stop		08 + Level data	Right [TWIN PBT] setting (0=max. CCW, 128=center, 255=max. CW)	
	01	Programmed scan (Prog 0)/ memory scan start		09 + Level data	[CW PITCH] setting (0=300 Hz, 128=600 Hz, 255=900 Hz; 5 Hz steps)	
	02	Programmed scan (Prog 0) start		0D + Level data	[NOTCH1] setting (0=low freq. to 255=high freq.)	
	03	Δ F scan start		11 + Level data	[AGC] control setting (0=max. CCW to 255=max. CW)	
	04	Auto memory write scan start		12 + Level data	[NB] control setting (0=max. CCW to 255=max. CW)	
	12	Fine programmed scan start		18 + Level data	[CONTRAST] setting (0=max. CCW to 255=max. CW)	
	13	Fine Δ F scan start	19 + Level data	[BRIGHT] setting (0=max. CCW to 255=max. CW)		
	22	Memory scan start	1A + Level data	[NOTCH2] setting (0=low freq. to 255=high freq.)		
	23	Select memory scan start	1B + Level data	[BASS] setting (0=max. CCW to 255=max. CW)		
	24	Mode select memory scan start	1C + Level data	[TREBLE] setting (0=max. CCW to 255=max. CW)		
	42	Priority scan (Prio 0) start				
A0	Set Δ F scan Fixed frequency ON					
AA	Set Δ F scan Fixed frequency OFF					
A1–A7	Set Δ F scan span (A1= \pm 5 kHz; A2= \pm 10 kHz; A3= \pm 20 kHz; A4= \pm 50 kHz; A5= \pm 100 kHz; A6= \pm 500 kHz; A7= \pm 1 MHz)					
B0	Set as non-select channel					
B1	Set as select channel (1–9= \star (SEL)1–9; when no data command is specified, the previously set number or " \star 1" is selected)					
B2	Set the number for select memory scan (0=ALL; 1–9= \star (SEL)1–9)					
D0	Set scan resume OFF					

13 CONTROL COMMAND

◇ Command table (continued)

Command	Sub command	Description
14	1D + Level data	[SCAN SPEED] setting (0=max. CCW to 255=max. CW)
	1E + Level data	[SCAN DELAY] setting (0=max. CCW to 255=max. CW)
15	01	Read squelch status
	02	Read signal (S-meter) level
	03+Sign+M-type	Read signal (dB meter) level Sign: 0/1=+/-, M-type 0/1/2=dBμ, dBμ[EMF], dBm
	04	Read center meter level
16	02	Preamp (0=OFF; 1=preamp 1; 2=preamp 2)
	12	AGC selection (0=OFF; 1=Fast; 2=Mid; 3=Slow)
	22	Noise blanker (0=OFF, 1=NB1, 2=NB2)
	32	Audio peak filter (APF type is SHARP; 0=OFF, 1=320 Hz, 2=160 Hz, 3=80 Hz), (APF type is SOFT; 0=OFF, 1=WIDE, 2=MID, 3=NAR)
	40	Noise reduction (0=OFF; 1=ON)
	41	Auto notch (0=OFF; 1=ON)
	43	Tone squelch (0=OFF; 1=ON)
	48	Manual notch1 (0=OFF; 1=ON)
	4A	AFC (0=OFF; 1=ON)
	4B	DTCS squelch (0=OFF; 1=ON)
	4C	VSC (0=OFF; 1=ON)
	4D	Manual AGC (0=OFF; 1=ON)
	4F	Twin peak filter (0=OFF; 1=ON)
	50	Dial lock (0=OFF; 1=ON)
	51	Manual notch2 (0=OFF; 1=ON)
	52	P25 Digital squelch (0=OFF; 1=NAC, 2=SEL)
19	00	Read the receiver information
1A	00	Send/read memory contents (see p. 13-10 for details)
	03	Send/read the selected filter width (AM: 0=200 Hz to 49=10 kHz; SSB, CW: 0=50 Hz to 40=3600 Hz; FSK: 0=50 Hz to 31=2700 Hz)
	04	Send/read the selected AGC time constant (AM: 0=OFF, 1=0.3 sec. to 13=8.0 sec., SSB, CW, FSK: 0=OFF, 1=0.1 sec. to 13=6.0 sec.)
	050001	Send/read FM Tone (Bass) level (0=-15 to 30=+15)
	050002	Send/read FM Tone (Treble) level (0=-15 to 30=+15)
	050003	Send/read WFM Tone (Bass) level (0=-15 to 30=+15)
	050004	Send/read WFM Tone (Treble) level (0=-15 to 30=+15)
	050005	Send/read AM Tone (Bass) level (0=-15 to 30=+15)
	050006	Send/read AM Tone (Treble) level (0=-15 to 30=+15)
	050007	Send/read SSB Tone (Bass) level (0=-15 to 30=+15)
	050008	Send/read SSB Tone (Treble) level (0=-15 to 30=+15)
050009	Send/read CW Tone (Bass) level (0=-15 to 30=+15)	
050010	Send/read CW Tone (Treble) level (0=-15 to 30=+15)	

Command	Sub command	Description
1A	050011	Send/read FSK Tone (Bass) level (0=-15 to 30=+15)
	050012	Send/read FSK Tone (Treble) level (0=-15 to 30=+15)
	050013	Send/read De-emphasis (FM 50k) (0=OFF, 1=ON)
	050014	Send/read De-emphasis (FM 15k) (0=OFF, 1=ON)
	050015	Send/read De-emphasis (FM 7k) (0=OFF, 1=ON)
	050016	Send/read AF high-cut filter (FM 50k) (0=OFF, 1=ON)
	050017	Send/read AF high-cut filter (FM 15k) (0=OFF, 1=ON)
	050018	Send/read AF high-cut filter (FM 7k) (0=OFF, 1=ON)
	050019	Send/read AF high-cut filter (WFM) (0=OFF, 1=ON)
	050020	Send/read AF high-cut filter (AM) (0=OFF, 1=ON)
	050021	Send/read AF high-cut filter (SSB) (0=OFF, 1=ON)
	050022	Send/read AF high-cut filter (CW) (0=OFF, 1=ON)
	050023	Send/read AF high-cut filter (FSK) (0=OFF, 1=ON)
	050024	Send/read AF high-cut filter (P25) (0=OFF, 1=ON)
	050025	Send/read speech level (0=0% to 255=100%)
	050026	Send/read beep gain (0=0% to 255=100%)
	050027	Send/read beep gain limit (0=OFF, 1=ON)
	050028	Send/read headphones output ratio (0=0.60 to 255=1.40)
	050029	Send/read SPEECH OUTPUT level (0=0% to 255=100%)
	050030	Send/read S/P DIF output level (0=0% to 255=100%)
	050031	Send/read REC REMOTE output (0=OFF, 1=ON)
	050032	Send/read external meter output selection (0=Signal, 1=Signal+SQL)
	050033	Send/read external meter output level (0=0% to 255=100%)
	050034	Send/read reference signal in/out setting (0=IN, 1=OFF, 2=OUT)
050035	Send/read reference signal fre- quency setting (0=0% to 255=100%)	
050036	Send/read screen image type (0=A, 1=B)	
050037	Send/read signal meter type (0=S, 1=dBμ, 2=dBμ[EMF], 3=dBm)	
050038	Send/read meter peak hold set (0=OFF, 1=ON)	
050039	Send/read memory name indica- tion setting (0=OFF, 1=ON)	
050040	Send/read audio peak filter width pop-up indication setting (0=OFF, 1=ON)	
050041	Send/read manual notch width pop-up indication setting (0=OFF, 1=ON)	

◇ Command table (continued)

Command	Sub command	Description	Command	Sub command	Description
1A	050042	Send/read P25 received ID pop-up indication setting (0=OFF, 1=ON(Dec), 2=ON(Hex))	1A	050072	Send/read CI-V transceiver set (0=OFF, 1=ON)
	050043	Send/read screen saver set (0=OFF, 1=15 min., 2=30 min., 3=60 min.)		050073	Send/read RS-232C function (0=CI-V, 1=Decode)
	050044	Send/read output signal setting for external display (0=OFF, 1=ON)		050074	Send/read RS-232C decode speed (0=300, 1=1200, 2=4800, 3=9600, 4=19200)
	050045	Send/read external display synchronous pulse level setting (0=L, 1=H)		050075	Send/read keyboard type (00=English, 01=Japanese, 02=United Kingdom, 03=French, 04=French (Canadian), 05=German, 06=Portuguese, 07=Portuguese (Brazilian), 08=Spanish, 09=Spanish (Latin American), 10=Italian)
	050046	Send/read opening message indication (0=OFF, 1=ON)		050076	Send/read keyboard repeat delay (10=100 msec. to 100=1000 msec.)
	050047	Send/read opening message contents (see p. 13-10 for details)		050077	Send/read keyboard repeat speed (0=2.0 cps to 31=30.0 cps)
	050048	Send/read date (20000101=1st Jan. 2000 to 20991231=31st Dec. 2099)		050078	Send/read IP address set (0000000000000001=0.0.0.1 to 0255025502550254=255.255.255.254)
	050049	Send/read time (0000=00:00 to 2359=23:59)		050079	Send/read subnet mask (1=128.0.0.0 to 30=255.255.255.252)
	050050	Send/read clock 2 function (0=OFF, 1=ON)		050080	Send/read TV type (0=NTSC M, 1=PAL B/G, 2=PAL I, 3=PAL D, 4=SECAM K)
	050051	Send/read offset time for clock 2 (240001=-24:00 to 240000=+24:00)		050081	Send/read the LCD contrast of the video signal from [VIDEO IN] (0=0% to 255=100%)
	050052	Send/read clock 2 name (Up to 3-character; see p. 13-10)		050082	Send/read the LCD brightness of the video signal from [VIDEO IN] (0=0% to 255=100%)
	050053	Send/read calibration marker (0=OFF, 1=ON)		050083	Send/read the saturation of the video signal from [VIDEO IN] (0=0% to 255=100%)
	050054	Send/read confirmation beep (0=OFF, 1=ON)		050084	Send/read the hue of the video signal from [VIDEO IN] (0=0% to 255=100%)
	050055	Send/read beep audio frequency (50=500 Hz to 200=2000 Hz)		050085	Send/read the frame trimming of the video signal from [VIDEO IN]. (0=OFF, 1=ON)
	050056	Send/read panel lock function set (0=ALL, 1=KEY)		050086	Send/read the wide screen set. (0=OFF, 1=ON)
	050057	Send/read speech language (0=English, 1=Japanese)		050087	Send/read the output video signal from [DATA IN] (0=VIDEO IN, 1=LCD)
	050058	Send/read speech speed (0=Slow, 1=Fast)		050088	Send/read the width of the output video signal from [DATA IN] (0=1 (narrow) to 3=4 (wide))
	050059	Send/read S-level speech (0=OFF, 1=ON)		050089	Send/read setup of the output video signal from [DATA IN] (0=0IRE (JPN NTSC), 1=7.5IRE (USA NTSC))
	050060	Send/read speech with a mode switch operation (0=OFF, 1=ON)		050090	Send/read output saturation level from [DATA IN] (0=0% to 255=100%)
	050061	Send/read REC Speech set (0=OFF, 1=ON)		050091	Send/read output hue level from [DATA IN]. (0=0% to 255=100%)
	050062	Send/read Speech Mix function set (0=OFF, 1=Operation, 2=All)		050092	Send/read the LCD contrast with dimmer OFF condition (0=0% to 255=100%)
	050063	Send/read main dial auto TS (0=OFF, 1=Low, 2=High)		050093	Send/read the LCD brightness with dimmer OFF condition (0=0% to 255=100%)
	050064	Send/read main dial click function mode set (0=Manual, 1=Auto)			
	050065	Send/read main dial click function set (When above is Manual; 0=OFF, 1=ON or Auto; 0=OFF, 1=Auto)			
	050066	Send/read main dial click (set mode, etc) function (0=OFF, 1=ON)			
	050067	Send/read main dial operation during scan (0=OFF, 1=Up/Down)			
	050068	Send/read AFC limit set (0=OFF, 1=ON)			
	050069	Send/read SSB/CW synchronous tuning function (0=OFF, 1=ON)			
	050070	Send/read CW normal side set (0=LSB, 1=USB)			
	050071	Send/read APF type (0=SHARP, 1=SOFT)			

13 CONTROL COMMAND

◇ Command table (continued)

Command	Sub command	Description
1A	050094	Send/read the LCD unit brightness with dimmer OFF condition (0=0% to 255=100%)
	050095	Send/read the key backlight with dimmer OFF condition (0=0% to 255=100%)
	050096	Send/read the LCD contrast with dimmer ON condition (0=0% to 255=100%)
	050097	Send/read the LCD brightness with dimmer ON condition (0=0% to 255=100%)
	050098	Send/read the LCD unit brightness with dimmer ON condition (0=0% to 255=100%)
	050099	Send/read the key backlight with dimmer ON condition (0=0% to 255=100%)
	050100	Send/read scope max. hold (0=OFF, 1=ON)
	050101	Send/read scope center frequency set (0=Filter center, 1=Carrier point center, 2=Carrier point center (Abs. Freq.))
	050102	Send/read waveform color for receiving signal (see p. 13-11 for details)
	050103	Send/read waveform color for max. hold (see p. 13-11 for details)
	050104	Send/read marker color for receiving signal (see p. 13-11 for details)
	050105	Send/read marker color for max. hold (see p. 13-11 for details)
	050106	Send/read scope peak excursion (0=0 dB to 80=80 dB)
	050107	Send/read scope peak threshold (0=-100 dB to 100=0 dB)
	050108	Send/read voice recorder's short play time (3=3 sec. to 10=10 sec.)
	050109	Send/read voice recorder short record time (5=5 sec. to 30=30 sec.)
	050110	Send/read voice recorder's recording quality (0=SQ1 (8 kHz), 1=SQ2 (12 kHz), 2=HQ1 (16 kHz) 3=HQ2(24 kHz) 4=SHQ (48 kHz))
	050111	Send/read REC remote set (0=OFF, 1=ON)
	050112	Send/read SPEECH Mix set (0=OFF, 1=Operation, 2=All)
	050113	Send/read speech mix level (0=0% (Receive audio only) to 255=100% (Speech audio only))
050114	Send/read memory bank limit set for memory channel selection (0=OFF, 1=ON)	
050115	Send/read memory bank limit set for memory scan (0=OFF, 1=ON)	
050116	Send/read memory bank name (Bank-0) (see p. 13-10 for details)	
050117	Send/read memory bank name (Bank-1) (see p. 13-10 for details)	

Command	Sub command	Description
1A	050118	Send/read memory bank name (Bank-2) (see p. 13-10 for details)
	050119	Send/read memory bank name (Bank-3) (see p. 13-10 for details)
	050120	Send/read memory bank name (Bank-4) (see p. 13-10 for details)
	050121	Send/read memory bank name (Bank-5) (see p. 13-10 for details)
	050122	Send/read memory bank name (Bank-6) (see p. 13-10 for details)
	050123	Send/read memory bank name (Bank-7) (see p. 13-10 for details)
	050124	Send/read memory bank name (Bank-8) (see p. 13-10 for details)
	050125	Send/read memory bank name (Bank-9) (see p. 13-10 for details)
	050126	Send/read memory bank name (Bank-A) (see p. 13-10 for details)
	050127	Send/read memory bank name (Bank-S) (see p. 13-10 for details)
	050128	Set/read FFT scope averaging set for FSK decoder (0=OFF, 1=2, 2=3, 3=4)
	050129	Set/read FFT scope waveform color set for FSK decoder (see p. 13-11 for details)
	050130	Send/read FSK decode USOS (0=OFF, 1=ON)
	050131	Send/read FSK decode new line code (0=CR,LF,CR+LF, 1=CR+LF)
	050132	Send/read clock selection for time stamp (0=Local time, 1=Clock 2)
	050133	Send/read frequency stamp (0=OFF, 1=ON)
	050134	Send/read FSK received text font color (see p. 13-11 for details)
	050135	Send/read time stamp text font color (see p. 13-11 for details)
	050136	Send/read skip scan set (0=OFF, 1=ON)
	050137	Send/read auto memory scan memory clear set (0=OFF, 1=[AUTO] Long Push, 2=ON)
050138	Send/read auto scan screen set when scan start (0=OFF, 1=ON)	
050139	Send/read NB1 depth (0=1 to 9=10)	
050140	Send/read NB1 width (0=0 to 255=100)	
050141	Send/read NB2 depth (0=1 to 9=10)	
050142	Send/read NB2 width (0=0 to 255=100)	
050143	Send/read TS (1 Hz) as selectable tuning step for FM (0=OFF, 1=ON)	
050144	Send/read TS (10 Hz) as selectable tuning step for FM (0=OFF, 1=ON)	
050145	Send/read TS (100 Hz) as selectable tuning step for FM (0=OFF, 1=ON)	
050146	Send/read TS (1 kHz) as selectable tuning step for FM (0=OFF, 1=ON)	

◇ Command table (continued)

Command	Sub command	Description	Command	Sub command	Description
1A	050147	Send/read TS (2.5 kHz) as selectable tuning step for FM (0=OFF, 1=ON)	1A	050169	Send/read TS (25 kHz) as selectable tuning step for WFM (0=OFF, 1=ON)
	050148	Send/read TS (5 Hz) as selectable tuning step for FM (0=OFF, 1=ON)		050170	Send/read TS (100 kHz) as selectable tuning step for WFM (0=OFF, 1=ON)
	050149	Send/read TS (6.25 kHz) as selectable tuning step for FM (0=OFF, 1=ON)		050171	Send/read TS (1 MHz) as selectable tuning step for WFM (0=OFF, 1=ON)
	050150	Send/read TS (9 kHz) as selectable tuning step for FM (0=OFF, 1=ON)		050172	Send/read TS (PROG) as selectable tuning step for WFM (0=OFF, 1=ON)
	050151	Send/read TS (10 kHz) as selectable tuning step for FM (0=OFF, 1=ON)		050173	Send/read TS (1 Hz) as selectable tuning step for AM (0=OFF, 1=ON)
	050152	Send/read TS (12.5 kHz) as selectable tuning step for FM (0=OFF, 1=ON)		050174	Send/read TS (10 Hz) as selectable tuning step for AM (0=OFF, 1=ON)
	050153	Send/read TS (20 kHz) as selectable tuning step for FM (0=OFF, 1=ON)		050175	Send/read TS (100 Hz) as selectable tuning step for AM (0=OFF, 1=ON)
	050154	Send/read TS (25 kHz) as selectable tuning step for FM (0=OFF, 1=ON)		050176	Send/read TS (1 kHz) as selectable tuning step for AM (0=OFF, 1=ON)
	050155	Send/read TS (100 kHz) as selectable tuning step for FM (0=OFF, 1=ON)		050177	Send/read TS (2.5 kHz) as selectable tuning step for AM (0=OFF, 1=ON)
	050156	Send/read TS (1 MHz) as selectable tuning step for FM (0=OFF, 1=ON)		050178	Send/read TS (5 Hz) as selectable tuning step for AM (0=OFF, 1=ON)
	050157	Send/read TS (PROG) as selectable tuning step for FM (0=OFF, 1=ON)		050179	Send/read TS (6.25 kHz) as selectable tuning step for AM (0=OFF, 1=ON)
	050158	Send/read TS (1 Hz) as selectable tuning step for WFM (0=OFF, 1=ON)		050180	Send/read TS (9 kHz) as selectable tuning step for AM (0=OFF, 1=ON)
	050159	Send/read TS (10 Hz) as selectable tuning step for WFM (0=OFF, 1=ON)		050181	Send/read TS (10 kHz) as selectable tuning step for AM (0=OFF, 1=ON)
	050160	Send/read TS (100 Hz) as selectable tuning step for WFM (0=OFF, 1=ON)		050182	Send/read TS (12.5 kHz) as selectable tuning step for AM (0=OFF, 1=ON)
	050161	Send/read TS (1 kHz) as selectable tuning step for WFM (0=OFF, 1=ON)		050183	Send/read TS (20 kHz) as selectable tuning step for AM (0=OFF, 1=ON)
	050162	Send/read TS (2.5 kHz) as selectable tuning step for WFM (0=OFF, 1=ON)		050184	Send/read TS (25 kHz) as selectable tuning step for AM (0=OFF, 1=ON)
	050163	Send/read TS (5 Hz) as selectable tuning step for WFM (0=OFF, 1=ON)		050185	Send/read TS (100 kHz) as selectable tuning step for AM (0=OFF, 1=ON)
	050164	Send/read TS (6.25 kHz) as selectable tuning step for WFM (0=OFF, 1=ON)		050186	Send/read TS (1 MHz) as selectable tuning step for AM (0=OFF, 1=ON)
	050165	Send/read TS (9 kHz) as selectable tuning step for WFM (0=OFF, 1=ON)		050187	Send/read TS (PROG) as selectable tuning step for AM (0=OFF, 1=ON)
	050166	Send/read TS (10 kHz) as selectable tuning step for WFM (0=OFF, 1=ON)		050188	Send/read TS (1 Hz) as selectable tuning step for SSB (0=OFF, 1=ON)
050167	Send/read TS (12.5 kHz) as selectable tuning step for WFM (0=OFF, 1=ON)	050189	Send/read TS (10 Hz) as selectable tuning step for SSB (0=OFF, 1=ON)		
050168	Send/read TS (20 kHz) as selectable tuning step for WFM (0=OFF, 1=ON)	050190	Send/read TS (100 Hz) as selectable tuning step for SSB (0=OFF, 1=ON)		

13 CONTROL COMMAND

◇ Command table (continued)

Command	Sub command	Description
1A	050191	Send/read TS (1 kHz) as selectable tuning step for SSB (0=OFF, 1=ON)
	050192	Send/read TS (2.5 kHz) as selectable tuning step for SSB (0=OFF, 1=ON)
	050193	Send/read TS (5 Hz) as selectable tuning step for SSB (0=OFF, 1=ON)
	050194	Send/read TS (6.25 kHz) as selectable tuning step for SSB (0=OFF, 1=ON)
	050195	Send/read TS (9 kHz) as selectable tuning step for SSB (0=OFF, 1=ON)
	050196	Send/read TS (10 kHz) as selectable tuning step for SSB (0=OFF, 1=ON)
	050197	Send/read TS (12.5 kHz) as selectable tuning step for SSB (0=OFF, 1=ON)
	050198	Send/read TS (20 kHz) as selectable tuning step for SSB (0=OFF, 1=ON)
	050199	Send/read TS (25 kHz) as selectable tuning step for SSB (0=OFF, 1=ON)
	050200	Send/read TS (100 kHz) as selectable tuning step for SSB (0=OFF, 1=ON)
	050201	Send/read TS (1 MHz) as selectable tuning step for SSB (0=OFF, 1=ON)
	050202	Send/read TS (PROG) as selectable tuning step for SSB (0=OFF, 1=ON)
	050203	Send/read TS (1 Hz) as selectable tuning step for CW (0=OFF, 1=ON)
	050204	Send/read TS (10 Hz) as selectable tuning step for CW (0=OFF, 1=ON)
	050205	Send/read TS (100 Hz) as selectable tuning step for CW (0=OFF, 1=ON)
	050206	Send/read TS (1 kHz) as selectable tuning step for CW (0=OFF, 1=ON)
	050207	Send/read TS (2.5 kHz) as selectable tuning step for CW (0=OFF, 1=ON)
	050208	Send/read TS (5 Hz) as selectable tuning step for CW (0=OFF, 1=ON)
	050209	Send/read TS (6.25 kHz) as selectable tuning step for CW (0=OFF, 1=ON)
	050210	Send/read TS (9 kHz) as selectable tuning step for CW (0=OFF, 1=ON)
050211	Send/read TS (10 kHz) as selectable tuning step for CW (0=OFF, 1=ON)	
050212	Send/read TS (12.5 kHz) as selectable tuning step for CW (0=OFF, 1=ON)	

Command	Sub command	Description
1A	050213	Send/read TS (20 kHz) as selectable tuning step for CW (0=OFF, 1=ON)
	050214	Send/read TS (25 kHz) as selectable tuning step for CW (0=OFF, 1=ON)
	050215	Send/read TS (100 kHz) as selectable tuning step for CW (0=OFF, 1=ON)
	050216	Send/read TS (1 MHz) as selectable tuning step for CW (0=OFF, 1=ON)
	050217	Send/read TS (PROG) as selectable tuning step for CW (0=OFF, 1=ON)
	050218	Send/read TS (1 Hz) as selectable tuning step for FSK (0=OFF, 1=ON)
	050219	Send/read TS (10 Hz) as selectable tuning step for FSK (0=OFF, 1=ON)
	050220	Send/read TS (100 Hz) as selectable tuning step for FSK (0=OFF, 1=ON)
	050221	Send/read TS (1 kHz) as selectable tuning step for FSK (0=OFF, 1=ON)
	050222	Send/read TS (2.5 kHz) as selectable tuning step for FSK (0=OFF, 1=ON)
	050223	Send/read TS (5 Hz) as selectable tuning step for FSK (0=OFF, 1=ON)
	050224	Send/read TS (6.25 kHz) as selectable tuning step for FSK (0=OFF, 1=ON)
	050225	Send/read TS (9 kHz) as selectable tuning step for FSK (0=OFF, 1=ON)
	050226	Send/read TS (10 kHz) as selectable tuning step for FSK (0=OFF, 1=ON)
	050227	Send/read TS (12.5 kHz) as selectable tuning step for FSK (0=OFF, 1=ON)
	050228	Send/read TS (20 kHz) as selectable tuning step for FSK (0=OFF, 1=ON)
	050229	Send/read TS (25 kHz) as selectable tuning step for FSK (0=OFF, 1=ON)
	050230	Send/read TS (100 kHz) as selectable tuning step for FSK (0=OFF, 1=ON)
	050231	Send/read TS (1 MHz) as selectable tuning step for FSK (0=OFF, 1=ON)
	050232	Send/read TS (PROG) as selectable tuning step for FSK (0=OFF, 1=ON)
050233	Send/read TS (1 Hz) as selectable tuning step for P25 (0=OFF, 1=ON)	
050234	Send/read TS (10 Hz) as selectable tuning step for P25 (0=OFF, 1=ON)	

◇ Command table (continued)

Command	Sub command	Description	Command	Sub command	Description
1A	050235	Send/read TS (100 Hz) as selectable tuning step for P25 (0=OFF, 1=ON)	1B	01	Set/read TSQL tone frequency. (see p. 13-10 for details)
	050236	Send/read TS (1 kHz) as selectable tuning step for P25 (0=OFF, 1=ON)		02	Set/read DTCS squelch code (see p. 13-10 for details)
	050237	Send/read TS (2.5 kHz) as selectable tuning step for P25 (0=OFF, 1=ON)		03	Set/read NAC squelch code (see p. 13-11 for details)
	050238	Send/read TS (5 Hz) as selectable tuning step for P25 (0=OFF, 1=ON)		04	Set/read TGID for selective squelch (see p. 13-11 for details)
	050239	Send/read TS (6.25 kHz) as selectable tuning step for P25 (0=OFF, 1=ON)		05	Set/read UNIT ID for selective squelch (see p. 13-11 for details)
	050240	Send/read TS (9 kHz) as selectable tuning step for P25 (0=OFF, 1=ON)	1D	00	Send/read remote function set (0=OFF, 1=REMOTE1 (locks VRs only), 2=REMOTE2 (locks VRs. Keys, and dials))
	050241	Send/read TS (10 kHz) as selectable tuning step for P25 (0=OFF, 1=ON)			
	050242	Send/read TS (12.5 kHz) as selectable tuning step for P25 (0=OFF, 1=ON)			
	050243	Send/read TS (20 kHz) as selectable tuning step for P25 (0=OFF, 1=ON)			
	050244	Send/read TS (25 kHz) as selectable tuning step for P25 (0=OFF, 1=ON)			
	050245	Send/read TS (100 kHz) as selectable tuning step for P25 (0=OFF, 1=ON)			
	050246	Send/read TS (1 MHz) as selectable tuning step for P25 (0=OFF, 1=ON)			
	050247	Send/read TS (PROG) as selectable tuning step for P25 (0=OFF, 1=ON)			
	050248	Send/read CW pitch set (0=300 Hz to 120=900 Hz in 5 Hz steps)			
	050249	Send/read FSK RX frequency (0=Mark(Space), 1=Mark/Space Center)			
	050250	Send/read FSK tone frequency (0=1275 Hz, 1=1500 Hz, 2=1615 Hz, 3=2125 Hz)			
	050251	Send/read FSK shift width (0=170 Hz, 1=200 Hz, 2=425 Hz, 3=800 Hz, 4=850 Hz)			
	08	Send/read DSP filter shape (0= sharp, 1= soft)			
	09	Send/read roofing filter set (FM/AM/SSB/CW/FSK; 0=3 kHz, 1=6 kHz, 2=15 kHz, 3=50 kHz, WFM; 4=240 kHz, P25; 2=15 kHz)			
	0A	Send/read manual notch1 width (0=Wide, 1=Mid., 2=Nar.)			
	0B	Send/read manual notch2 width (0=Wide, 1=Mid., 2=Nar.)			

13 CONTROL COMMAND

◇ To send/read memory contents

When sending or reading memory contents, additional codes must be added to appoint the memory channel as follows.

➤ Additional code: 0000–1219

• Memory channel code

Code	Bank number	Memory Channel
0000–0999	Bank-0–Bank-9	0–999
1000–1099	Bank-A (Auto)	A00–A99
1100–1199	Bank-S (Skip)	S00–S99
1200–1219	Bank-P (Scan edge)	P0A–P9B

• Memory bank code

Code	Bank number
00–09	Bank-0–Bank-9
10	Bank-A (Auto)
11	Bank-S (Slip)
12	Bank-P (Scan edge)

◇ Codes for memory name, bank name, opening message and clock 2 name contents

To send or read the desired memory name settings, the character codes as follows are used.

• Character's code

Character	ASCII code	Description
0–9	30–39	Numerals
A–Z	41–5A	Alphabetical characters
a–z	61–7A	Alphabetical characters
space	20	Word space

• Character's code— Symbols

Character	ASCII code	Character	ASCII code
!	21	#	23
\$	24	%	25
&	26	¥	5C
?	3F	"	22
'	27	`	60
^	5E	+	2B
–	2D	*	2A
/	2F	.	2E
,	2C	:	3A
;	3B	=	3D
<	3C	>	3E
(28)	29
[5B]	5D
{	7B	}	7D
	7C	_	5F
–	7E	@	40

◇ Offset frequency setting

The following data sequence is used when sending or reading the offset frequency setting.

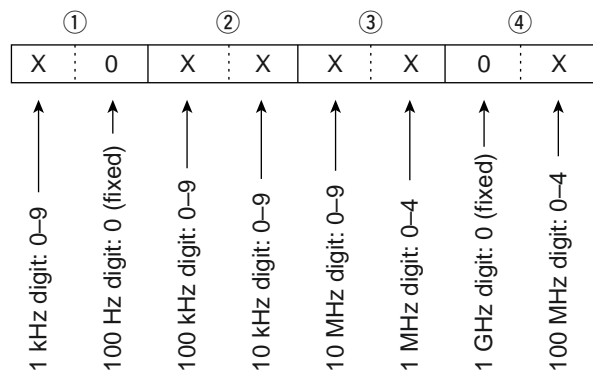

◇ Tone squelch frequency setting

The following data sequence is used when sending or reading the tone frequency setting.

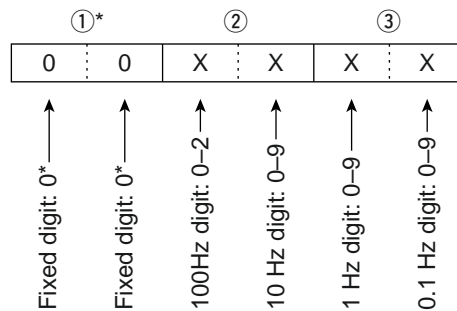

*Not necessary when setting a frequency.

◇ DTCS squelch code setting

The following data sequence is used when sending or reading the DTCS code setting.

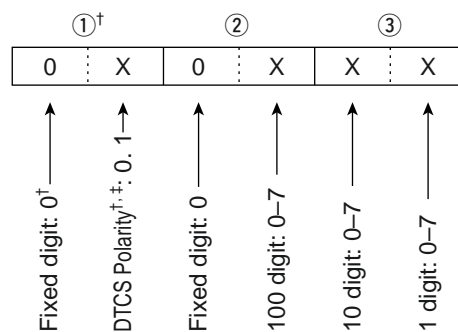

†Not necessary when normal is set.

‡0=Normal, 1=Reverse

◆ NAC squelch code setting

The following data sequence is used when sending or reading the NAC code setting.

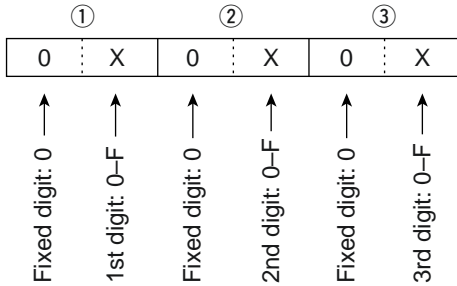

Selectable NAC: 0 0 0 - F F F

◆ Color setting

The following data sequence is used when sending or reading the color setting.

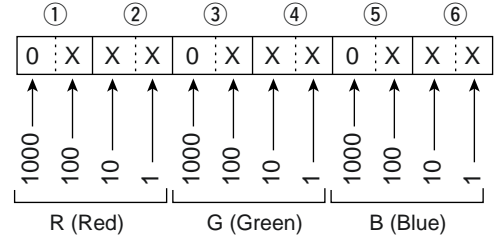

Using 0000-0255 for each color element.

◆ Selective squelch code settings

• TGID setting

The following data sequence is used when sending or reading the TGID code setting.

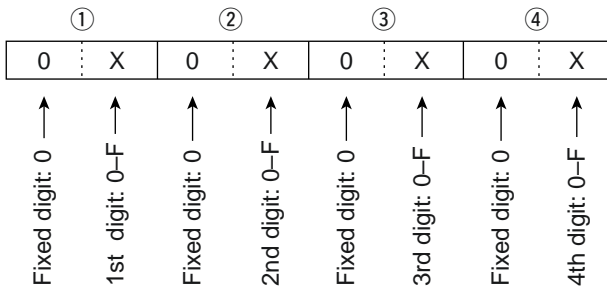

Selectable TGID: 0 0 0 0 - F F F F

• UNIT ID setting

The following data sequence is used when sending or reading the UNIT ID code setting.

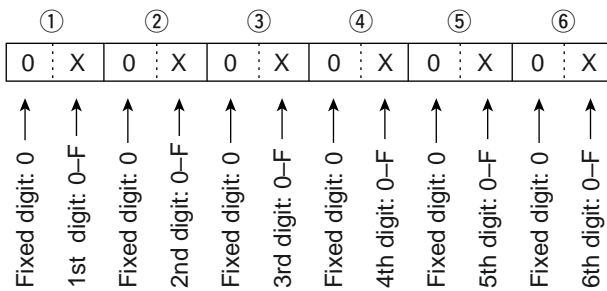

Selectable UNIT ID: 0 0 0 0 0 1 - 9 8 9 6 7 F

■ Specifications	14-2
◇ General	14-2
◇ Receiver	14-3
■ Options	14-4

■ Specifications

◇ General

- **Frequency coverage** (unit: MHz) :
 - USA : 0.005000–821.999999, 851.000000–866.999999
896.000000–3335.000000
 - France : 0.005000–29.999999, 50.200000–51.200000,
87.500000–108.000000, 144.000000–146.000000,
430.000000–440.000000, 1240.000000–1300.000000
 - Europe, U.K., USA-01, EXP, Australia : 0.005000–3335.000000
- **Operating mode** : USB, LSB, CW, FSK, AM, FM, WFM, P25 (with UT-122)
- **Number of memory channels** : 1220 (1000 regular channels, 100 auto memory write channels, 100 skip channels, 20 scan edge channels)
- **Antenna connector** : Type-N×2 (antenna impedance: 50 Ω),
SO-239×1 (antenna impedance: 50 Ω),
Phono (RCA)×1 (antenna impedance: 500 Ω)
- **Operating temperature range** : 0°C to +50°C; +32°F to +122°F
- **Frequency stability** : Less than ±0.05 ppm (approx. 5 min. after from turn the main power, [I/O], ON, 0–50°C; 32–122°F)
- **Frequency resolution** : 1 Hz
- **Power supply requirement** : 100 V, 120 V, 230 V, 240 V AC
- **Power consumption** :
 - Receive : Less than 100 VA
 - Stand-by : Less than 100 VA
 - Max. audio
- **Dimensions** (projections not included) : 424×149×340 mm; 16¹¹/₁₆×5⁷/₈×13³/₈ in
- **Weight** : Approx. 20 kg; 44 lb
- **ACC connector** : 8-pin DIN connector
- **DATA IN connector** : 8-pin DIN connector
- **Display*** : 7-inch (diagonal) TFT color LCD (800×480)
- **EXT-DISPLAY connector** : D-sub 15S
- **RS-232C connector** : D-sub 9-pin
- **VIDEO IN connector** : Phono (RCA)
- **VIDEO OUT connector** : Phono (RCA)
- **SPEECH OUT connector** : Phono (RCA)
- **LINE OUT connector** : Phono (RCA)
- **USB connector** : USB (Universal Serial Bus)1.1/2.0
- **CI-V connector** : 2-conductor 3.5 (d) mm (1/8")
- **ANT-SEL connector** : 3-conductor 3.5 (d) mm (1/8")
- **DET OUT connector** : 3-conductor 3.5 (d) mm (1/8")
- **EXT-SP connectors** : 2-conductor 3.5 (d) mm (1/8")/8 Ω
- **REC REMOTE connector** : 3-conductor 3.5 (d) mm (1/8")×2
(Front and rear panels)
- **REC OUT connector** : 3-conductor 3.5 (d) mm (1/8")
- **PHONES connector** : 3-conductor 3.5 (d) mm (1/8")

All stated specifications are typical and subject to change without notice or obligation.

◇ Receiver

- **Sensitivity** :

SSB, CW, FSK (BW (SSB, FSK)=2.4 kHz, (CW)=500 Hz, 10 dB S/N)	
0.100–1.799 MHz	0.5 μ V (pre-amp 1 ON)
1.800–29.999 MHz	0.2 μ V (pre-amp 1 ON)
30.000–2999.999 MHz	0.32 μ V (pre-amp ON)
3000.000–3335.000 MHz	1 μ V (pre-amp ON)
AM (BW=6 kHz, 10 dB S/N)	
0.100–1.799 MHz	6.3 μ V (pre-amp 1 ON)
1.800–29.999 MHz	2.5 μ V (pre-amp 1 ON)
30.000–2999.999 MHz	3.5 μ V (pre-amp ON)
3000.000–3335.000 MHz	11 μ V (pre-amp ON)
FM (BW=15 kHz, 12 dB SINAD)	
28.000–29.990 MHz	0.5 μ V (pre-amp 1 ON)
30.000–2999.999 MHz	0.5 μ V (pre-amp ON)
3000.000–3335.000 MHz	1.6 μ V (pre-amp ON)
FM50k (BW=50 kHz, 12 dB SINAD)	
28.000–29.990 MHz	0.71 μ V (pre-amp 1 ON)
30.000–2999.999 MHz	0.71 μ V (pre-amp ON)
3000.000–3335.000 MHz	2.2 μ V (pre-amp ON)
WFM (BW=180 kHz, 12 dB SINAD)	
30.000–2999.999 MHz	1.4 μ V (pre-amp ON)
3000.000–3335.000 MHz	4.5 μ V (pre-amp ON)
- **Internal modulation distortion** (typical) : Dynamic range 109 dB
(at 14.100 MHz, 100 kHz separation, Pre-amp 1 OFF)
- **Selectivity** :

SSB, FSK (BW=2.4 kHz)	More than 2.4 kHz/–3 dB Less than 3.6 kHz/–60 dB
CW (BW=500 Hz)	More than 500 Hz/–3 dB Less than 700 Hz/–60 dB
AM (BW=6 kHz)	More than 6.0 kHz/–3 dB Less than 15.0 kHz/–60 dB
FM (BW=15 kHz)	More than 12.0 kHz/–3 dB Less than 25.0 kHz/–60 dB
WFM	More than 180.0 kHz/–6 dB
- **Spurious and image rejection response ratio** :

0.1000–30.000 MHz	More than 70 dB
30.000–2500.000 MHz	More than 50 dB
2500.000–3000.000 MHz	More than 40 dB
- **Audio output power** : More than 2.6 W at 10% distortion with an 8 Ω load

*The LCD display may have cosmetic imperfections that appear as small or dark spots. This is not a malfunction or defect, but a normal characteristic of LCD displays.

Spurious signals may be received near the following frequencies. These are made in the internal circuit and does not indicate a receiver malfunction.

- 114.110 kHz, • 229.280 kHz, • 8.636 MHz, • 10.749 MHz, • 66.671 MHz, • 119.259 MHz,
- 161.732 MHz, • 200.865 MHz, • 440.865 MHz, • 1226.749 MHz, • 1269.398 MHz, • 1317.398 MHz,
- 1410.649 MHz, • 1439.999 MHz, • 1599.999 MHz, • 1645.449 MHz, • 1674.799 MHz, • 1810.773 MHz,
- 1856.098 MHz, • 1875.665 MHz, • 2005.448 MHz, • 2154.798 MHz, • 2336.099 MHz, • 2394.798 MHz,
- 2512.199 MHz, • 2799.999 MHz, • 2842.848 MHz, • 2933.500 MHz, • 2999.999 MHz, • 3199.999 MHz,
- 3232.198 MHz, • 3261.548 MHz

Spurious waveforms may be displayed on the spectrum scope screen regardless of the receiver's condition. They are made in the scope circuit. This does not indicate a receiver malfunction.

■ Options

• **CT-17** CI-V LEVEL CONVERTER



For remote receivers control using a PC. You can change frequencies, operating mode, memory channels, etc. (software is not included)

• **SP-20** EXTERNAL SPEAKER



4 audio filters; headphone jack; can connect to 2 receivers.

- Input impedance : 8 Ω
- Max. input power : 5 W

• **UT-122** DIGITAL UNIT



Provides P25 (digital) mode operation.

■ General	15-2
■ Caution	15-2
■ Preparation	15-3
◇ Firmware and firm utility	15-3
◇ File downloading	15-3
■ Firmware update— USB-Memory	15-4
■ Firmware update— PC	15-6
◇ Connections	15-6
◇ IP address setting	15-7
◇ Updating from the PC	15-8

■ General

At least one available USB (2.0 or 1.1) port is required to copy the downloaded firmware file. An Ethernet card/board (10 BASE-T/100 BASE TX compatible) is required when updating the firmware from the PC. The USB hub and Ethernet card/board are not supplied by Icom. Ask your PC dealer about a USB hub and an Ethernet card/board for details.

The IC-R9500's firmware can be updated if desired. By updating the firmware, new function(s) can be added and performance parameters improved.

2 methods of firmware update are available; one uses the USB-Memory, and the other uses a PC. You can choose either method according to your PC capabilities.

- When only one PC that is connected to the INTERNET is available
 - ➔ Refer to ■ Preparation (p. 15-3) and ■ Firmware update—USB-Memory (p. 15-4)
- When two or more PCs that are connected to the INTERNET are available and they are connected to a LAN (Local Area Network)
 - ➔ Refer to ■ Preparation (p. 15-3) and either
 - Firmware update—PC (p. 15-6) or
 - Firmware update—USB-Memory (p. 15-4)

Ask your dealer or distributor about how to update the firmware if you have no PC.

■ Caution

⚠ **CAUTION!:** NEVER turn the receiver power OFF while updating the firmware. You can turn the receiver power OFF only when the receiver display shows that rebooting is required. If you turn the receiver power OFF, or if a power failure occurs during updating, the receiver firmware will be corrupted and you will have to send the receiver back to the nearest Icom distributor for repair. This type of repair is out of warranty even if the warranty period is still valid.

Recommendation!

Backing up the settings and/or memory contents to the CF card or USB-Memory before starting the firmware update is recommended. Settings and/or memory contents will be lost or returned to default settings when the firmware update is performed.

■ Preparation

◇ Firmware and firm utility

The latest firmware and the firm utility can be downloaded from the Icom home page via the INTERNET. Access the following URL to download the firm utility and the latest firmware.

<http://www.icom.co.jp/world/download/index.htm>

For updating from the USB-Memory

When updating the firmware from the USB-Memory, copy the downloaded firmware data (e.g. 9500xxxx.dat) to the USB-Memory (in "IC-R9500" folder) using an available USB port (USB hub may be required; purchased separately from your PC dealer).

◇ File downloading

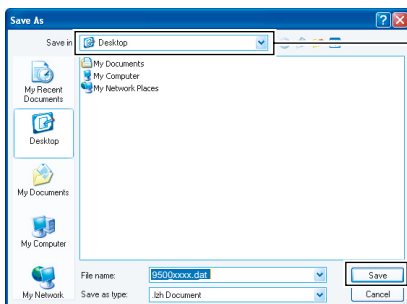
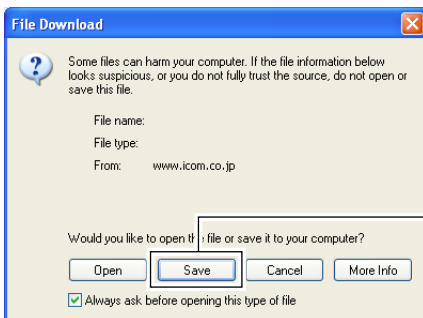
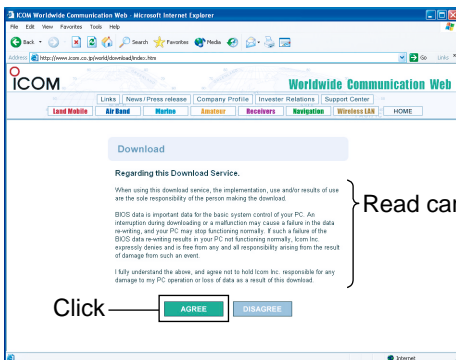

- ① Access the following URL directly.
<http://www.icom.co.jp/world/download/index.htm>
 - No link is available from the top page.
- ② Read "Regarding this Download Service" carefully, then click [AGREE].
- ③ Click "IC-R9500" link then click the firmware file link.

- ④ Click [Save] in the displayed File Download dialog.

- ⑤ Select the desired location to which you want to save the firmware, then click [Save] in the displayed File Download dialog.

- File download starts.

- ⑥ After download is completed, extract the file.
 - The firmware and the firm utility are compressed in "zip" format, respectively.
 - When updating the receiver using with the USB-Memory, copy the extracted firmware (e.g. 9500xxxx.dat) to the USB-Memory IC-R9500 folder.
 - The USB-Memory must have been formatted by the IC-R9500 (p. 11-23).

■ Firmware update—USB-Memory

When updating the firmware with the CF card or USB-Memory, no IP address or subnet mask settings are necessary.

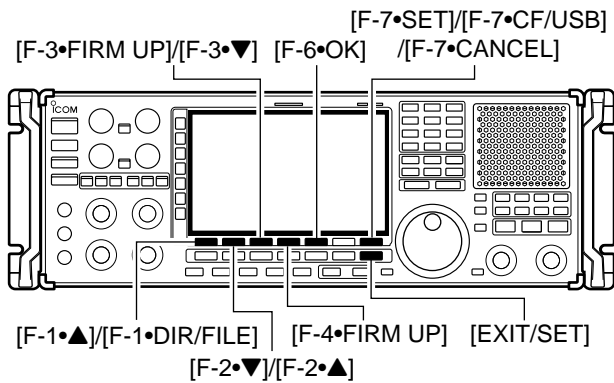

- ① Copy the downloaded firmware data into the USB-Memory (“IC-R9500” folder).
 - The USB-Memory must have been formatted by the IC-R9500.
- ② Insert the USB-Memory into the USB connector.
- ③ Push [EXIT/SET] several times to close a multi-function screen, if necessary.
- ④ Push [F-7•SET] to select set mode menu screen.
- ⑤ Push [F-7•CF/USB] to select CF/USB-Memory set menu.

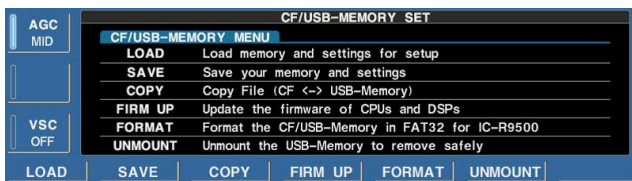

- ⑥ Push and hold [F-3•FIRM UP] for 1 sec.

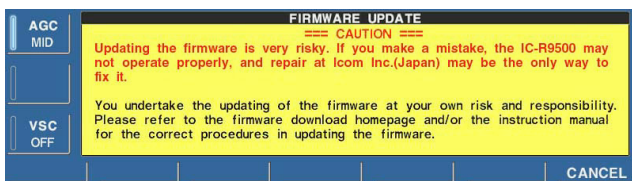

- ⑦ Read the displayed precautions carefully.
 - Push [F-1•▲] or [F-2•▼] to scroll the text.
 - Push [F-7•CANCEL] to cancel firmware updating.

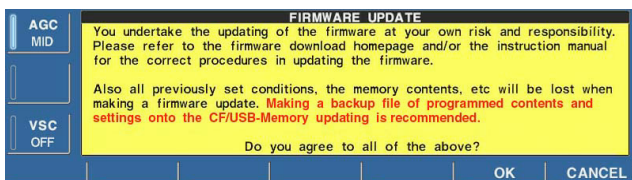

- ⑧ After you read and understand all of the precautions, push [F-6•OK].
 - [F-6•OK] appears only following the precautions.
 - Push [F-7•CANCEL] to cancel the firmware updating.

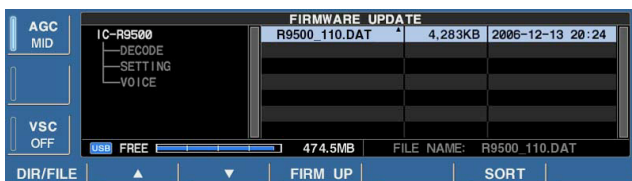

- ⑨ Push [F-2•▲] or [F-3•▼] to select the firmware file, then push [F-4•FIRM UP].
 - Push and hold [F-1•DIR/FILE] for 1 sec. to select the USB-Memory, if CF card is selected.

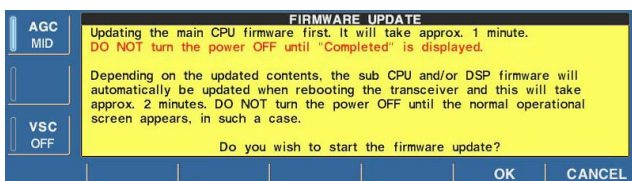

- ⑩ Read the displayed precautions carefully.
- ⑪ If you agree, push [F-6•OK] for 1 sec. to start the firmware update.
 - Push [F-7•CANCEL] to cancel firmware updating.

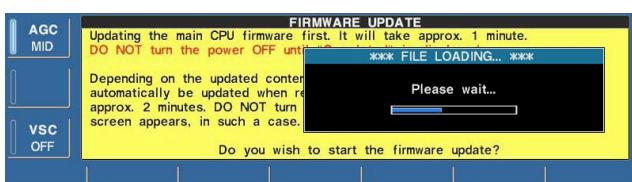

- ⑫ While loading the firmware from the CF memory card, the dialog at left is displayed.

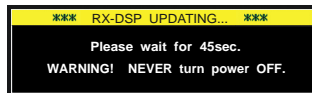
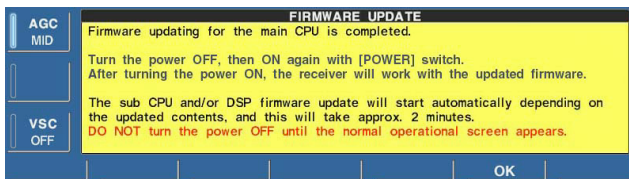
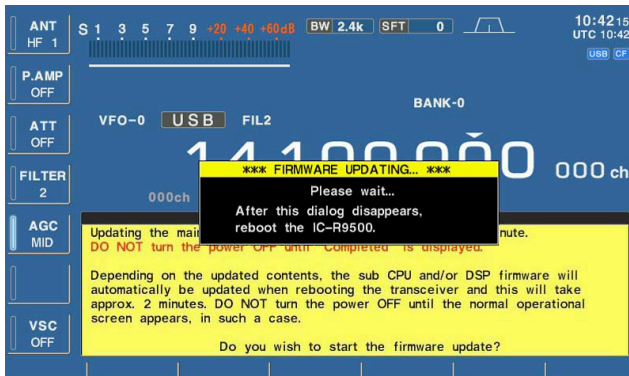

⑬ After firmware loading is completed, the receiver starts the update automatically and the dialog at left is displayed.

⚠ **WARNING!** NEVER turn the IC-R9500 power OFF at this stage.
 The receiver firmware will be damaged.

⑭ When the dialog disappears, the precaution as at left is displayed.

⑮ Read the precaution carefully, and then push [F-6•OK].
 • Return to CF/USB-Memory set menu.

⑯ Push [POWER] to turn the IC-R9500 power OFF, then ON again.

⑰ Depending on the status of the update process, either of dialogs at left will appears in sequence.

⚠ **WARNING!** NEVER turn the IC-R9500 power OFF at this stage.
 The receiver firmware will be corrupted.

⑱ After the dialog disappears, the firmware update is completed and the normal operation screen appears.

■ Firmware update— PC

◇ Connections

Connect the IC-R9500 and the PC through a LAN (Local Area Network) as follows.

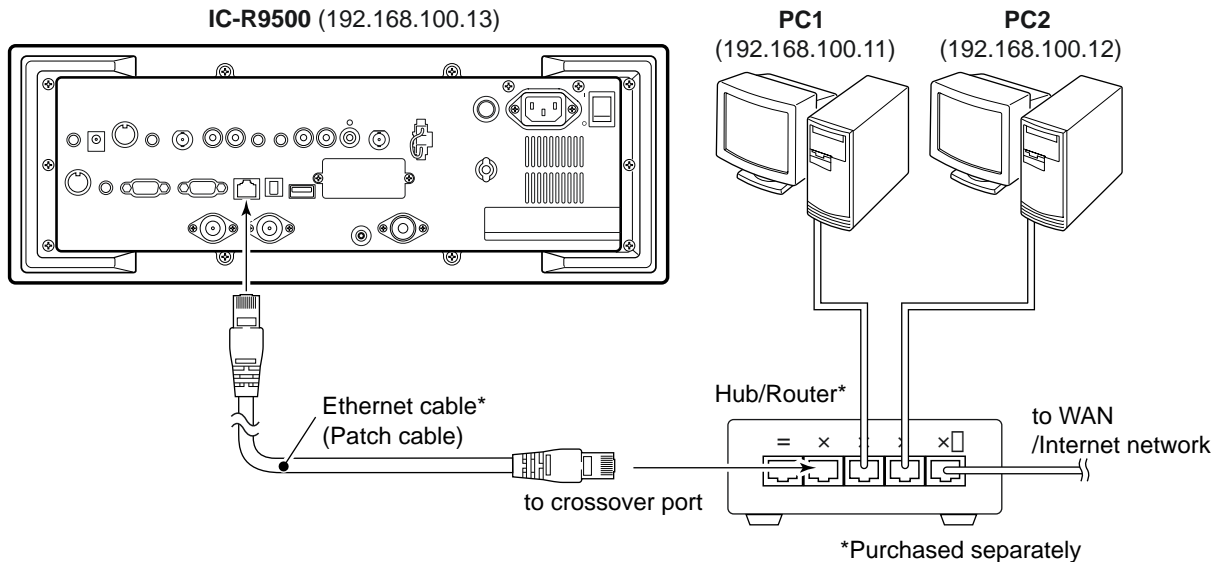

• IP address setting example

	PC1	PC2	IC-R9500
IP address	192.168.100.11	192.168.100.12	192.168.100.13
Subnet mask	255.255.255.0	255.255.255.0	255.255.255.0

◇ IP address setting

When updating the firmware from the USB-Memory, setting the IP address is not necessary.

IMPORTANT! A fixed (static) IP address is used for the IC-R9500.

When you connect the IC-R9500 to a LAN, ask the network manager about a usable/assignable IP address and the subnet mask in advance.

NEVER use an IP address that has already been allocated to another device in the network. If the IP address is duplicated, the network will crash.

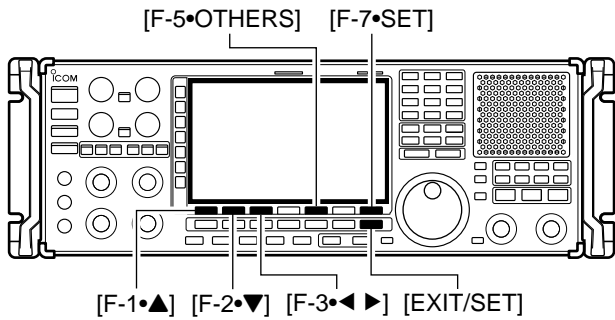

- ① Push [EXIT/SET] several times to close a multi-function screen, if necessary.
- ② Push [F-7•SET] to select set mode menu screen.
- ③ Push [F-5•OTHERS] to select the others set mode.

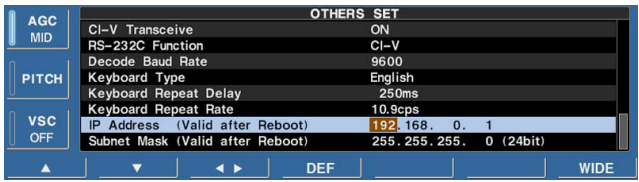

- ④ Push [F-1•▲]/[F-2•▼] several times to select “IP Address.”
- ⑤ Push [F-3•◀▶] to select the desired segment then rotate main dial to set the desired or specified IP address.

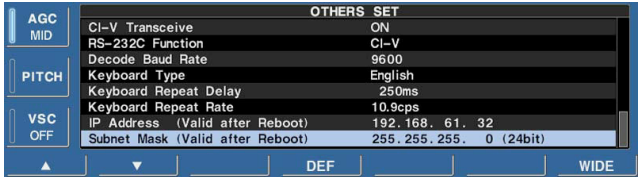

- “192.168.0.1” is the default setting.
- ⑥ Push [F-2•▼] to select “Subnet Mask” item.
 - ⑦ Rotate main dial to set the desired or specified subnet mask.
 - “255.255.255.0” is the default setting.
 - ⑧ Push [POWER] to turn the receiver power OFF, then ON to accept the new IP address and subnet mask settings.

◇ Updating from the PC

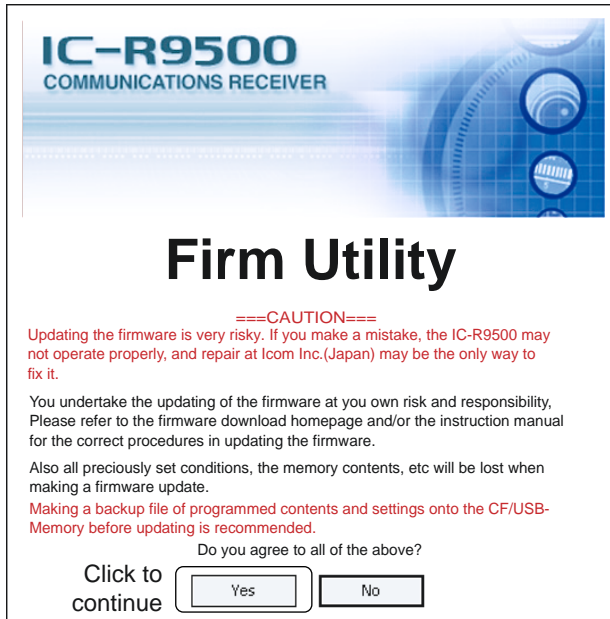

- ① Start up the IC-R9500 Firm Utility.
 - The window as at left appears.
- ② Read the caution in the window carefully.
- ③ Click [Yes] if you agree and to continue the firmware updating.

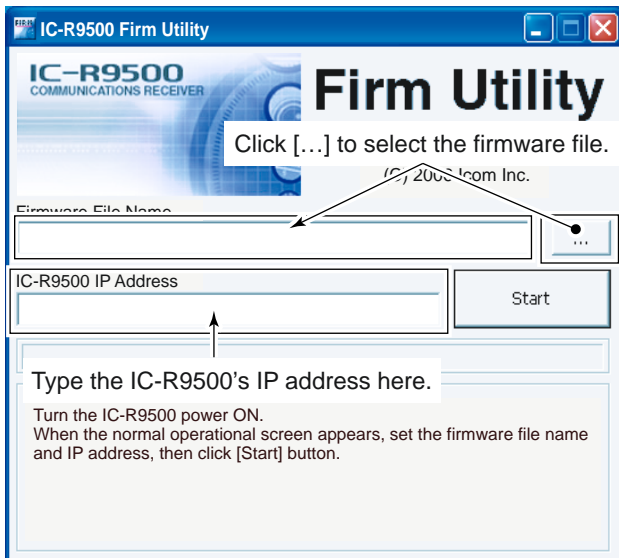

- ④ Select the firmware file with the "dat" extension (e.g.: 9500xxxx.dat).
 - Click [...], then select the file, as well as the location.
- ⑤ Type the IC-R9500's IP address into "IC-R9500 IP Address" text box.
- ⑥ Click [Start].

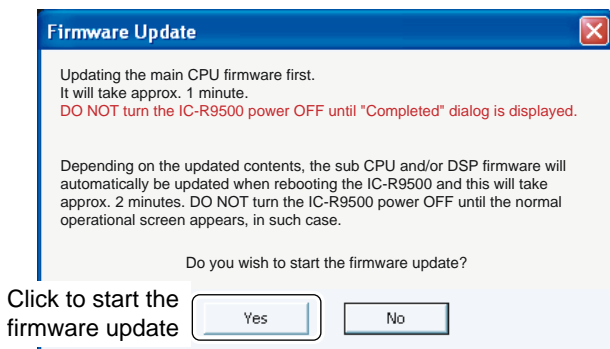

- ⑦ The window at left appears.
 Read the precaution in the window carefully.
- ⑧ Click [Yes] if you want to start the firmware update.

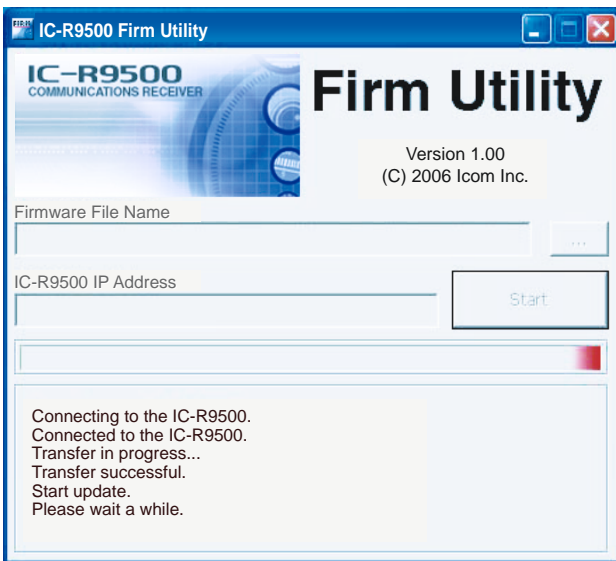

- ⑨ The screen at left is displayed.
 - The following dialog appears in the IC-R9500 display.

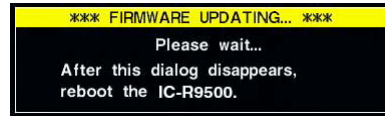

⚠ **WARNING!** NEVER turn the IC-R9500 power OFF at this stage.
 The receiver firmware will be corrupted.

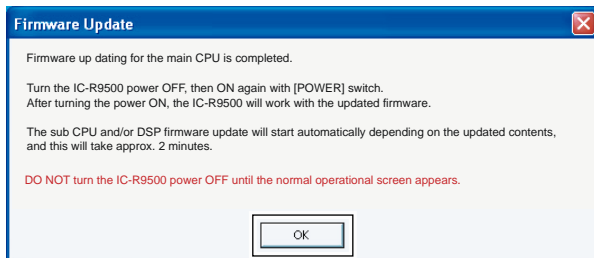

Click [OK] to finish the firmware update.

- ⑩ Click [OK] to finish the firmware update.
 - The “FIRMWARE UPDATING” dialog as above disappears.
- ⑪ Push [POWER] to turn the IC-R9500 power OFF, then ON again.

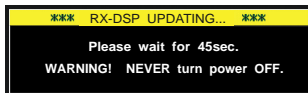
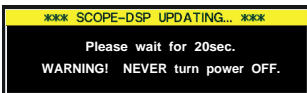

- ⑫ Depending on the status of the update process, either of dialogs at left will appear in sequence.

⚠ **WARNING!** NEVER turn the IC-R9500 power OFF at this stage.
 The receiver firmware will be corrupted.

- ⑬ After the dialog disappears, the firmware update is completed and the normal operation screen appears.



We Icom Inc. Japan
1-1-32, Kamiminami, Hirano-ku
Osaka 547-0003, Japan

Declare on our sole responsibility that this equipment complies with the essential requirements of the Radio and Telecommunications Terminal Equipment Directive, 1999/5/EC, and that any applicable Essential Test Suite measurements have been performed.

Kind of equipment: COMMUNICATIONS RECEIVER

Type-designation: IC-R9500

Version (where applicable):

This compliance is based on conformity with the following harmonised standards, specifications or documents:

- i) Article 3.1a EN 60950-1 (2001):A11:2004
- ii) Article 3.1b EN 301489-1 and EN 301489-15
- iii) Article 3.2 EN 301 783-2

DECLARATION OF CONFORMITY



Düsseldorf 19th Jan.2007
Place and date of issue

Icom (Europe) GmbH
Himmelgeister straÙe 100
D-40225 Düsseldorf

Authorized representative name
H. Ikegami
General Manager

Signature

Icom Inc.

Please record the serial number of your IC-R9500 receiver below for future servicing reference:

Serial Number :

Date of purchase :

Place where purchased :

Count on us!

IC-R9500
#03 (France)

<Intended Country of Use>			
<input type="checkbox"/> GER	<input checked="" type="checkbox"/> FRA	<input type="checkbox"/> ESP	<input type="checkbox"/> SWE
<input type="checkbox"/> AUT	<input type="checkbox"/> NED	<input type="checkbox"/> POR	<input type="checkbox"/> DEN
<input type="checkbox"/> GBR	<input type="checkbox"/> BEL	<input type="checkbox"/> ITA	<input type="checkbox"/> FIN
<input type="checkbox"/> IRL	<input type="checkbox"/> LUX	<input type="checkbox"/> GRE	<input type="checkbox"/> SUI
<input type="checkbox"/> NOR			

IC-R9500
#04 (Europe)

<Intended Country of Use>			
<input checked="" type="checkbox"/> GER	<input type="checkbox"/> FRA	<input checked="" type="checkbox"/> ESP	<input checked="" type="checkbox"/> SWE
<input checked="" type="checkbox"/> AUT	<input checked="" type="checkbox"/> NED	<input checked="" type="checkbox"/> POR	<input checked="" type="checkbox"/> DEN
<input type="checkbox"/> GBR	<input checked="" type="checkbox"/> BEL	<input checked="" type="checkbox"/> ITA	<input checked="" type="checkbox"/> FIN
<input checked="" type="checkbox"/> IRL	<input checked="" type="checkbox"/> LUX	<input checked="" type="checkbox"/> GRE	<input checked="" type="checkbox"/> SUI
<input checked="" type="checkbox"/> NOR			

IC-R9500
#05 (United
Kingdom)

<Intended Country of Use>			
<input type="checkbox"/> GER	<input type="checkbox"/> FRA	<input type="checkbox"/> ESP	<input type="checkbox"/> SWE
<input type="checkbox"/> AUT	<input type="checkbox"/> NED	<input type="checkbox"/> POR	<input type="checkbox"/> DEN
<input checked="" type="checkbox"/> GBR	<input type="checkbox"/> BEL	<input type="checkbox"/> ITA	<input type="checkbox"/> FIN
<input type="checkbox"/> IRL	<input type="checkbox"/> LUX	<input type="checkbox"/> GRE	<input type="checkbox"/> SUI
<input type="checkbox"/> NOR			